

- 1 • Spindle bearing units / spindle bottom parts for spinning and twisting spindles
 - Spindle lubricating apparatus with accessories
- 2 • Contact roll assemblies for tangential belt drives
 - Tension pulleys with shells
 - Bearing units
- 3 • Top rollers LP
 - Top roller lubricating equipment and accessories
- 4 • Bottom roller bearings
- 5 • Weighting arms with equipment and draft system data
 - Top apron cradles
 - Condensers
 - Distance clips
 - Setting tools
 - Pneumatic accessories
- 6 • Rotor spindles
 - Beater spindles
 - Bearing units
- 7 • Bearing units for texturizing aggregates
 - Counter rolls
 - Separator rolls
 - Lubricating equipment and accessories for separator rolls
- 8 • Lubrication and servicing
 - Testing and measuring
 - Bearing units for textile machines
- 9 • Recommendations for optimized spinning with TEXParts spindles and TEXParts draft equipment
- 10 • Textile terms
 - General technical terms
- 11 • Sales Companies and Representatives
- 12 • Complete list of Product Reference Numbers

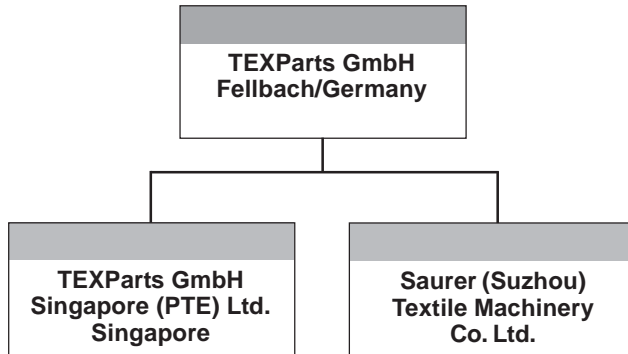



2nd revised edition 2004
Research and development will never come to a halt. This may mean that some informations in this Almanac may be obsolete by technical progress.

Printed in Germany

Issued by TEXParts GmbH
Technical Information Department

© Copyright TEXParts GmbH 2004

TEXParts: Innovation has a new name

TEXParts GmbH was founded in April 1999 and has taken over the product program of SKF Textilmaschinen Komponenten GmbH.

Due to 80 years' market leadership for textile machine components in the area of spinning and twisting, we can offer you today as TEXParts GmbH the basis for the production of top-quality yarns.

Our draft systems, spindles, spindle drives and textile bearings for the OE- and texturing area are sophisticated spinning machine components tested million of times and equipped with most modern technique.

TEXParts GmbH follows SKF rich in tradition with innovative, forward-looking new developments, high productivity and efficient service as well with textile-technological know-how.

And we also have taken over service and care on site from SKF.

In more than 40 countries our representatives are directly present to give assistance to your needs. Customer closeness and the fulfilment of the wishes of our customers is our main aim.

But there are also some changes.

At our location in Germany and our production sites in Singapore and China we are able to produce still more efficiently on highest quality level by means of optimal production processes and most modern machines.

Besides the world-wide marketing network we have changed our marketing organisation in our centre with the aim to realise a still quicker customer-friendly service.

On our Website www.texparts.de you get information about our existing products and new developments per touch of the button.

By securing our quality standards and our efficient marketing organisation we want to maintain and expand our market leadership.

In doing so we want to be a confident partner for our customers in the field of spinning mechanical engineering who have been with us for many years as well as for our customers in the spinning mills.

With the TEXParts product catalogue 'Product Information 2004' we present you our current products and technology news.

Spindle bearing units/spindle bottom parts for spinning and twisting spindles Spindle lubricating apparatus and accessories	1
Spindle bearing units HF- Insert without bolster	2
Spindle bearing units HZ-Insert with bolster	2
Spindle units CS1	6
Spindle units CS1 12	8
Spindle bearing units BI-FLEX	10
Complete spindles	12
Spindle lubricating apparatus 1254 106	14
Lubrication adapters and accessories for spindle bearing units CS, HF, HZ and SF	15



TEXParts Spindle bearing units HF Insert without bolster



Application

Spindle insert HF for spinning and twisting spindles operating with or without ring and traveller, with light to medium loads and high speeds.

See also chapter 9 page 2.

Spindle Bearing Units for special applications upon request.

Ring frames
Twisting frames

Cotton mills
Worsted mills
Doubling mills

Chapter 1-2

Types Ref. no.	Dimensions in mm			Q	I max.	Shape of footstep bearing	Weight kg
	A	R	P				
HF 3-0952 502	158,0	21,7	8,8	5,50	15,5	I	0,147
HF 3-0952 503 ¹⁾	158,0	21,7	8,8	5,50	15,5	I	0,147
HF 35-1254 243 ²⁾	158,0	21,7	8,8	8,45	15,5	II	
HF 44-0952 757	173,5	23,8	10,0	6,45	16,5	II	0,214
HF 44-0952 760 ¹⁾	173,5	23,8	10,0	6,45	16,5	II	0,190
HF 45-1258 940 ²⁾	173,5	23,8	10,0	7,95	16,5	II	0,214

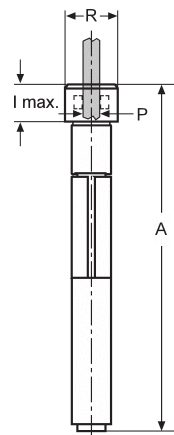
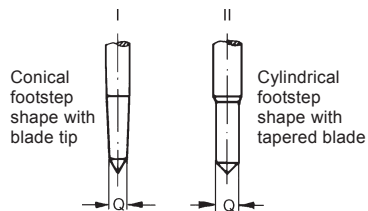

HF 3
HF 35
HF 44
HF 45

¹⁾ Version with special damping spring for spinning and twisting with suppressed yarn balloon.

²⁾ Version for application in Two-for-One spindles.

TEXParts Spindle bearing units HZ Insert with bolster

Application

Spindle bolster HZ for spinning and twisting spindles to operate with or without ring and traveller with high speeds and all kinds of load from light to very heavy.

Spindle Bearing Units for special applications upon request.

Ring frames
Twisting frames

Cotton mills
Worsted mills
Twisting mills

Types Ref.no	Dimensions in mm				Q	H	H ₁	H ₂	M	Weight kg
	A	R	P	Q						
HZ 33-0019 871 ¹⁾	146,0	21,7	8,8	5,45	55,0	37,0	54,0	M 25 x 1,5	0,313	
HZ 35-0018 299 ¹⁾	163,5	21,7	8,8	8,45	55,0	54,5	54,0	M 25 x 1,5	0,342	
HZ 440-0029 250	178,5	23,7	10,0	6,45	100,0	47,5	31,0	M 27 x 1,5	0,468	
HZ 55-0952 204	188,0	28,2	12,0	7,95	115,0	37,0	36,0	M 32 x 1,5	0,734	
HZ 66-0014 227	229,0	32,5	14,0	8,95	144,5	56,0	28,5	M 35 x 1,5	0,927	
HZ 68-0017 830	229,0	32,5	14,0	10,95	144,5	56,0	28,5	M 35 x 1,5	0,930	
HZ 77-0952 381	273,0	37,8	16,0	10,95	123,0	100,5	40,5	M 40 x 1,5	1,750	

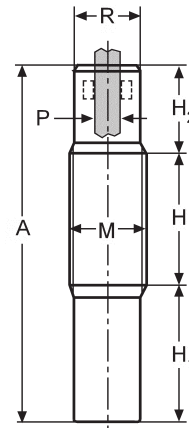
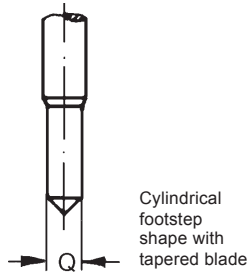

HZ 33
HZ 35
HZ 440
HZ 55
HZ 66
HZ 68
HZ 77

¹⁾ Version for application in Two-for-One spindles.



TEXParts Spindle units CS1



Application

Spindle unit CS1
-compact spindle bearing unit- for spinning spindles in cotton and worsted ring frames with speeds up to 25 000 rpm.

See also chapter 9
page 2.

TEXParts supplies the CS1 with different flange versions, with and without hook and brake, ready to be installed, for all types of ring spinning machines.
CS1 versions without flange are also available.

Ring frames

Cotton mills
Worsted mills

Chapter 1-6

CSRG ring

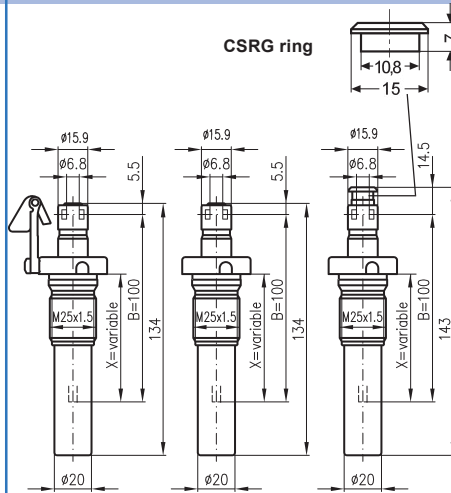

CS1-
Version with
hook



Cylindrical
footstep
shape with
spherical tip
4,5

CS1-
Version
hookless

CS1-
Version with
inner locking
hookless

The spare part Ref. no. of the **locking ring** for the spindle version with inner locking is 1257 888 (Standard Version) and 1258 576 (Rieter Version). An appropriate **unlocking lever** can be supplied upon request.

Examples for the possible design of CS1:

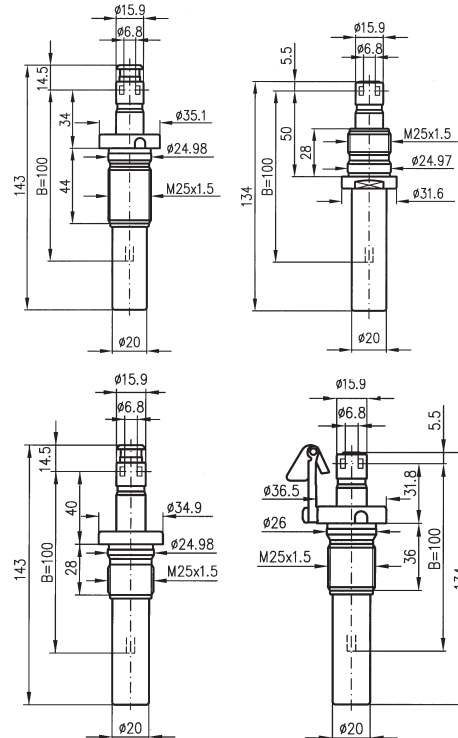

Remarks

The indicated types are examples for the possible design of CS1.

The relevant flange dimensions are adjusted to the relations of dimensions of each specific ring spinning machine.

Chapter 1-7



TEXParts Spindle units CS1 12



Application

Spindle unit CS1 12 -compact spindle bearing unit - for spinning spindles in cotton and worsted ring frames for coarse yarns as well as for spinning with suppressed yarn ballon and for spinning with big tube sizes.

See also chapter 9 page 2.

Ring frames

Cotton mills
Worsted mills

Chapter 1-8

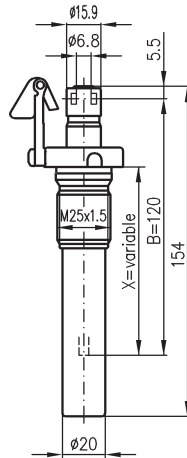

CS1 12 - Version with hook

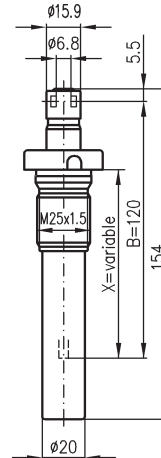

CS1 12 -
Version hookless

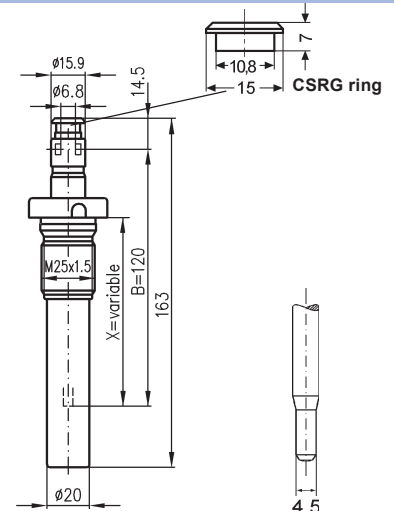

CS1 12 -
Version with inner locking



Cylindrical
footstep
shape with
spherical tip

The CS1 12 differs from the standard spindle bearing unit of CS1 series by a bearing distance of 120 mm (dimension B). The indicated types are examples for the possible design of CS1 12. TEXParts supplies the CS1 12 with different flange versions, with and without hook and brake, ready to be installed, for all types of ring spinning machines. The relevant flange dimensions are adjusted to the relations of dimensions of each specific ring spinning machine.

The spare part ref. no. of the **locking ring** for the spindle version with inner locking is 1257 888. An appropriate **unlocking lever** can be supplied upon request.

Chapter 1-9

TEXParts Spindle bearing units BI-FLEX

Application

Heavy spindle bearing unit in BI-FLEX design for high speed applications in draw twisting frames.

Types Ref. No

SMM 32-1280 013
SMM 42-1280 014

Weight kg

0,664
1,041

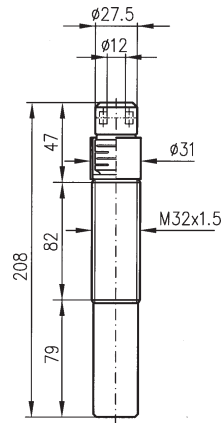

SMM 32-1280 013

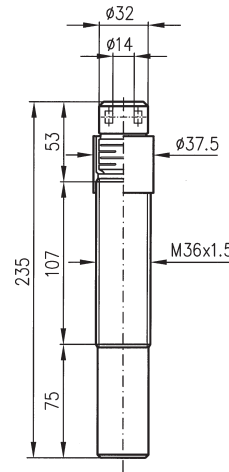

SMM 42-1280 014

Twisting frames

Twisting mills



TEXParts Complete spindles



Application

For spinning and twisting processes.

TEXParts offers a comprehensive range of complete spindles for various kinds of spinning and twisting processes:

- Cotton spindles with bare blades or with aluminium plugs
- Worsted or semi-worsted spindles with or without spinning crowns resp. spinning fingers
- Spindles for draw twisters, for small cop sizes
- Spindles for twisting frames

All spindles are being optimized considering

- the tubes to be used,
- the type of spindle drive,
- the minimum and maximum speed required and
- other customers' demands.

The spindles will be equipped with the most suitable bearing unit. Furthermore, a wide-ranged variety of different flange-, brake- and locking types as well as other spindle accessories are available. Highest precision in manufacture as precondition for a steady and vibration-reduced operation as well as a long-lasting service life of the spindle are guaranteed.

Complete spindles supplied by TEXParts are high-tech products. The efficiency of each spindle speaks for itself:

- reduction in energy requirements and running noise.
- high spindle speeds up to 30 000 rpm
- low-vibration running
- minimization of spindle oscillations

Please ask for TEXParts questionnaire for complete spindle inquiries.

Some examples of light spinning and twisting spindles:

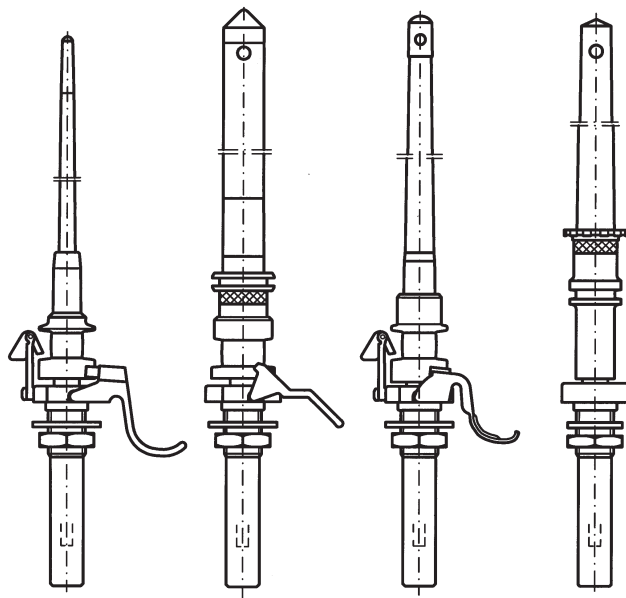

Cotton mills
Worsted mills
Twisting mills



TEXParts Spindle lubricating apparatus 1254 106

Application

Lubricating apparatus for servicing TEXParts and SKF spindle bearing units CS, HF, HZ and SF.

See also chapter 8 page 12.

Ring frames
Twisting frames

Cotton mills
Worsted mills
Twisting mills

Chapter 1-14

Type
Ref.no.

1254 106

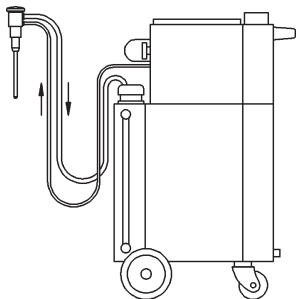

Dimensions in mm:

Length: 450; Width: 380; Height: 720
Weight: 29 kg net

Electric drive:

The TEXParts spindle lubricating apparatus is available with electric drive 1x220 V and 1x110 V. Please specify.

Note:

The standard supply of the spindle lubricating apparatus does not include any adapter. These have to be ordered as separate item. For Ref. No. of adapters see next page.

Product

Lubricating apparatus with an electrically driven pump

TEXParts Lubrication adapters and Accessories for spindle bearing units CS, HF, HZ and SF



Application

Lubrication adapters for lubricating apparatus 1254 106 for servicing TEXParts and SKF spindle bearing units CS, HF, HZ and SF.

See also chapter 8 page 12.

- ¹⁾ Standard version
- ²⁾ Version with inner locking
- ³⁾ Replacement for adapters 0994 250, 0034 279 and 0992 952
- ⁴⁾ Long version
- ⁵⁾ Short version

Ring frames
Twisting frames

Cotton mills
Worsted mills
Twisting mills

Chapter 1-15

Adapter
Ref.no.

1253 181

CS 1¹⁾

1253 182

CS 1²⁾

1256 450

CS 1 12¹⁾

1256 451

CS 1 12²⁾

0019 983

↑ HF 1-0025 144¹⁾
↓ SF 100

HZ 1 -1247 317¹⁾

1260 233³⁾⁴⁾

↑ HF 21-0013 802¹⁾

6001 019³⁾⁵⁾

↓ HF 21-1251 595²⁾

HF 21-1249 016¹⁾
SF 210

0994 252

↑ HF 3-0952 502
↓ HZ 30-1249 017

HF 3-0952 503

0017 392

HZ 33-0019 871

0021 818

HF 35-0018 300

0998 112

↑ HF 44-0952 757
↓ HF 45-0952 766

HF 44-0952 760
HZ 440-0029 250

0998 111

HZ 55-0952 204

0994 253

HZ 66-0014 227

HZ 68-0017 830

0998 279

HZ 77-0952 381

Contact roll assemblies for tangential belt drives Tension pulleys with shells, bearing units,	1
Contact roll assemblies AR 5047	2
Contact roll assemblies AR 3528	4
Contact roll assemblies AR 5024	6
Bearing units ZB, ZL	8
Tension pulley SR	10
Tension pulley SR	12
Bearing unit CK	12
Bearing units FR and SR	14
Bearing units SR	16
Bearing units ZL and CR	18
Bearing units DR	20
Draw-off rollers with cots CK and ZL	22



TEXParts Contact roll assemblies AR 5047

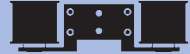

Application

For ring frames and twisting machines with tangential belt drives.
Belt width up to approx. 40mm max.

For use in one-belt and two-belt arrangements.
See also chapter 9 page 15.

For lubrication see chapter 8 page 2.

Types Ref.no.	Spindle gauge mm	Dimensions in mm			Weight kg	Remarks
		A	B	C		
AR 5047-1253 979	70	138	49,9	41,3	0,548	AR 5047 can be used as replacement for former types AR 28, AR 45, AR 15 and AR 13. If AR 5047 is mounted to replace AR 13 distance piece ADZ-0013 365 will be needed.
AR 5047-1253 935	75	147	58,9	41,3	0,552	
AR 5047-1253 980	82,5	162	73,9	41,3	0,556	

Weight
kg

Remarks

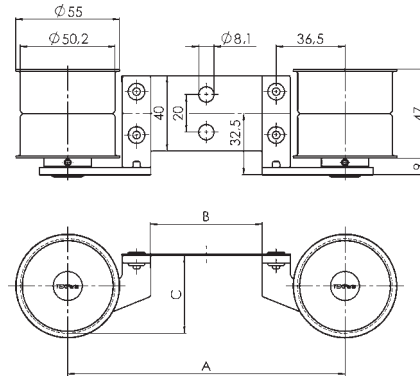

AR 5047-1253 935

Ring frames

Cotton mills Worsted mills



TEXParts Contact roll assemblies AR 3528



Application

For ring frames with multi-motor single tangential belt drives. Belt width up to approx. 20mm max.

For lubrication see chapter 8 page 2.

Types Ref.no.	Spindle gauge mm	Dimensions in mm			Weight kg
		A	B	C	
AR 3528-1254 645	70	138	49,8	39,6	0,350
AR 3528-1254 646	75	148	59,8	39,6	0,353
AR 3528-1254 647	82,5	162	73,8	39,6	0,357
AR 3528-1256 633 ¹⁾	82,5	91	36,9	39,6	0,176
AR 3528-1256 546	75	148	59,8	34,6	0,175
AR 3528-1256 547	82,5	167	78,8	34,6	0,175

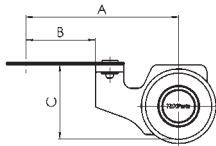
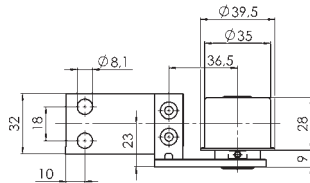

AR 3528-1256 633¹⁾

¹⁾righthand half contact roll assembly

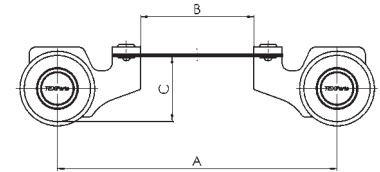
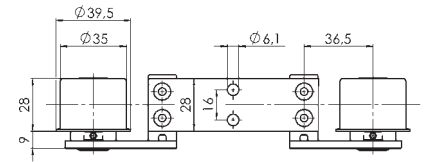

AR 3528-1256 546
AR 3528-1256 547

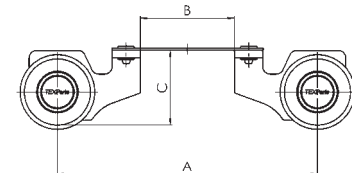
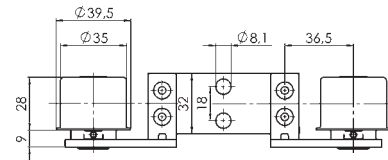

AR 3528-1254 645
AR 3528-1254 646
AR 3528-1254 647

Ring frames

Cotton mills

TEXParts

Contact roll assemblies AR 5024



Application

For ring frames with sectional drive.
Belt width up to approx. 16mm max.

See also chapter 9 page 15.

For lubrication see chapter 8 page 2.

Types Ref.no.	Spindle gauge mm	Dimensions in mm		C	Weight kg	AR 5024 to replace former types AR 50	
		A	B				
AR 5024-1253 978	70	142	53,9	13,9	0,371	-	
AR 5024-1253 990 RE ¹⁾	70	71	26,8	13,9	0,187	-	
AR 5024-1253 986 LI ²⁾	70	71	26,8	13,9	0,187	-	
AR 5024-1253 936	75	148	59,9	13,9	0,373	AR 50-1246 555	AR 50-0028 249
AR 5024-1253 991 RE ¹⁾	75	74	29,9	13,9	0,188	AR 50-1246 645 RE	AR 50-0030 027 RE
AR 5024-1253 987 LI ²⁾	75	74	29,9	13,9	0,188	AR 50-1246 647 LI	AR 50-0030 023 LI

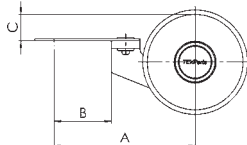
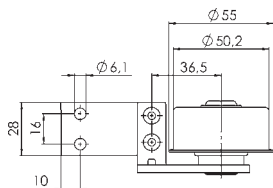

AR 5024-1253 987 LI²⁾

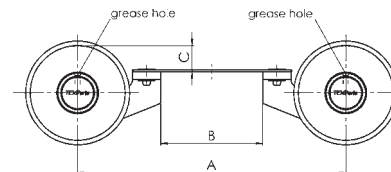
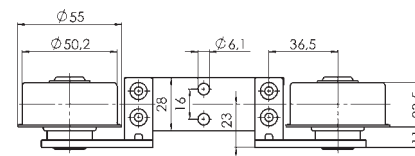

AR 5024-1253 978

Ring frames

Cotton mills Worsted mills

¹⁾ righthand half contact roll assembly

²⁾ lefthand half contact roll assembly

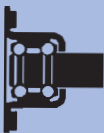

TEXParts Bearing units ZB, ZL



Application

Tension pulleys for guiding and tensioning the tape or the belt in belt drives.

As guide or tension pulley in general engineering applications.

Types Ref.no.	Max. speed n min ⁻¹	Load fig. in N		Weight kg
		C	C ₀	
ZB 7-0009 023	8000	3380	1220	0,080
ZL 7-0009 941¹⁾	10000	3380	1220	0,043

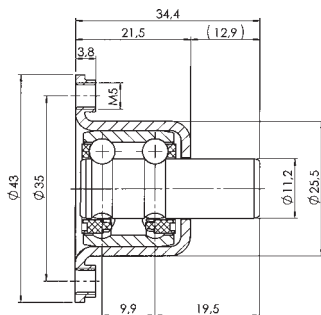

ZB 7-0009 023

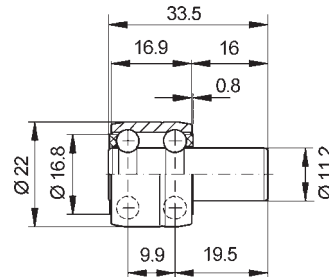

ZL 7-0009 941¹⁾

Ring frames
Twisting frames

Textile machinery
General engineering
applications

¹⁾ Delivery ex works ungreased and without cap.

TEXParts Tension pulley SR

Application

Tension pulley SR 5047 for guiding and tensioning the tape or the belt in belt drives.

As guide or tension pulley in general engineering applications.

See also chapter 8 page 16.

Types Ref.no.	Max. speed n min ⁻¹	Load fig. in N		Weight kg	Max. belt width mm	Remarks
		C	C ₀			
SR 5047-1255 698	12000	2700	1020	0,265	38	Tension pulley with angle (lefthand)
SR 5047-1255 699	12000	2700	1020	0,265	38	Tension pulley with angle (righthand)

Top view of angle see drawing of AR 5047 on chapter 2 page 2.

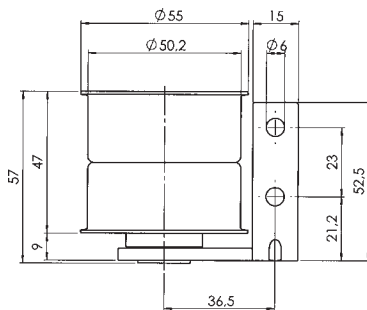

SR 5047-1255 698

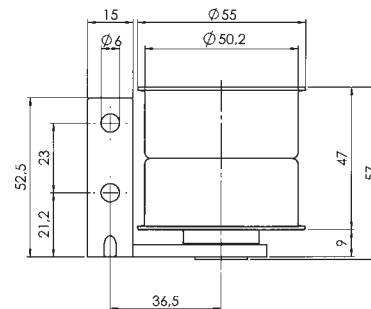

SR 5047-1255 699

Ring frames
Twisting frames

Textile machinery
General engineering
applications



TEXParts Tension pulley SR Bearing unit CK



Application

Tension pulley SR 28 for guiding the tangential belt return in two-belt arrangements.

Tension pulley SR 45 for guiding and tensioning the tape or the belt in belt drives.

As guide or tension pulley in general engineering applications.

See also chapter 8 page 16 and chapter 9 page 15.

Ring frames
Twisting frames

Textile machinery
General engineering
applications

Types Ref.no.	Max. speed n min ⁻¹	Load fig. in N C C ₀		Weight kg	Max. belt width mm	Nut SMT Ref. no.	Remarks
SR 28-0012 474	15000	3320	1180	0,179	38	SMT-0012 478	Nut SMT for tension pulleys SR 28 is not included in standard supply and has to be ordered as separate item.
SR 28-0012 473	15000	3320	1180	0,184	38	SMT-0012 478	
SR 45-0028 044	16000	3900	1560	0,164	35		Tension pulley is balanced.
CK 11-0007 749	30000	2250	900	0,060	30		

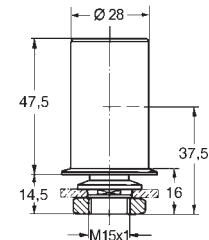
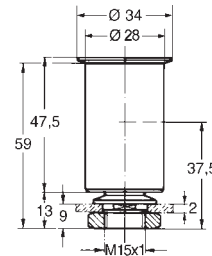
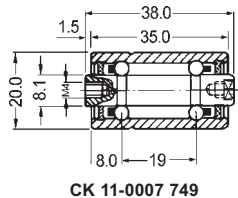
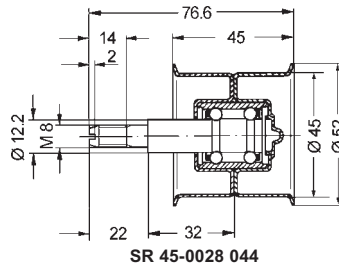



TEXParts Bearing unit FR



Application

Guide roller FR as bearing unit for gear mechanisms and pulleys, as guide roller for the belts in cone drives.

Types Ref.no.	Max. speed n min ⁻¹	Load fig. in N C dyn.	C ₀ stat.	Weight kg
FR 232-0964 351	15000	3800 I 1780 II	2900 I 630 II	0,246

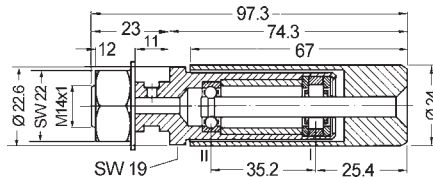

FR 232-0964 351

Limits for stud diameter
d: 0/-0,01 mm

Textile machinery
General engineering
applications

- ¹⁾ with anti-torque protection.
²⁾ black finished version.

I = roller bearing; II = ball bearing

TEXParts Bearing units SR



Application

Bearing units SR for tension pulleys, gear mechanisms and other pulleys.

Types Ref.no.	Dimensions in mm						SW	N	A ³⁾	A ₁	A ₂	A ₃	A ₄	A ₅	A ₆	S	S ₁	Max. speed n min ⁻¹	Load fig. in N		Weight kg
	d	D ₁	D ₂	G	C	C ₀ stat.															
SR 23-0953 801	7,8	19,4	24,6	M21x1	27	26,5		84	34,6	19,3	20,5	7,5	9	4,5	25,7	31,6	20000	3800 I 1780 II	2900 I 630 II	0,095	
SR 23-0953 901²⁾	7,8	19,4	24,6	M21x1	27	26,5		84	34,6	19,3	20,5	7,5	9	4,5	25,7	31,6	20000	3800 I 1780 II	2900 I 630 II	0,095	
SR 24-0027 755¹⁾	7,8	19,4	24,6	M21x1	27	26,5		95	43,6	20,4	20,5	7,5	9	12,5	26,8	41,6	20000	3800 I 1780 II	2900 I 630 II	0,135	
SR 24-0954 051	7,8	19,4	24,6	M21x1	27	26,5		95	43,6	20,4	20,5	7,5	9	12,5	26,8	41,6	20000	3800 I 1780 II	2900 I 630 II	0,135	
SR 35-0954 151	8,8	21,5	29,6	M25x1	32	30,5		114	57,2	22,6	22,0	8,5	11	23,0	29	55,8	20000	4400 I 2700 II	3400 I 1000 II	0,248	

**Textile machinery
General engineering
applications**

- ¹⁾ black-finished version
²⁾ with double-edged wrench, size across flats = SW 22
³⁾ Dimension A = Total length of bearing (housing and shaft) plus length of plastic cap.

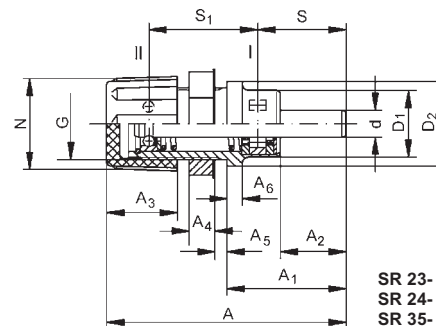

I = roller bearing; II = ball bearing
 Limits for stud. dia. d: 0/-0,01 mm



TEXParts Bearing units ZL and CR



Application

Bearing unit ZL for toothed wheels and other pulleys.

Bearing Unit CR 2 for textile machines and general engineering applications.

Types Ref.no.	Dimensions in mm				A	A ₁	A ₂	A ₃	G	J	S	S ₁	Max. speed min ⁻¹	Load fig. in N	
	d	D	D ₁	D ₂										C	C ₀
ZL 11-0028 553 ²⁾	8,0	20,0	2,5	-	38,5	23,0	-	-	-	-	21,0	12,0	20000	2290	950
ZL 17-0016 949 ³⁾⁴⁾	7,5	18,0	16,3	-	30,0	22,0	-	16,3	-	-	14,0	10,5	5000	2080 I 2160 II	540 I 710 II
CR 2-0035 905 ¹⁾²⁾	7,8	17,79	18,0	-	35,0	16,0	12,0	-	-	-	20,0	12,5	15000	3800 I 1780 II	2900 I 630 II

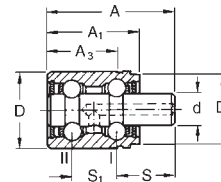

ZL 17-0016 949³⁾⁴⁾

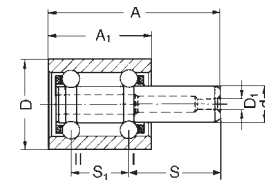

ZL 11-0028 553²⁾

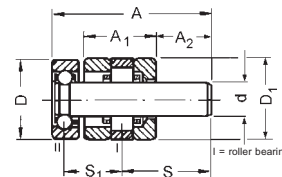

CR 2-0035 905¹⁾²⁾

¹⁾ Delivery ex works ungreased.

²⁾ Delivery ex works without cap.

³⁾ Counter bearing for CR2-0035 905.

⁴⁾ Former Ref.no. ZL 17-0013 040

Designation I/II = different raceway shapes

Limits of stud. dia. d: 0/-0,01 mm

Limits of outer ring dia. D: 0/-0,01 mm

**Textile machinery
General engineering
applications**



TEXParts Bearing units DR



Application

For winders and for general engineering applications.

Types Ref.no.	Dimensions in mm				A	A ₁	A ₂	S	S ₁	Max. speed n min ⁻¹	Load fig. in N		Weight kg
	d	D	D ₁	D ₂							C	C ₀	
DR 1620-0958 201¹⁾	7,5	16	14,0	14,0	40	20	12,0	15,8	12,5	10000	1370 I 1060 II	630 I 140 II	0,026
DR 1620-0958 251¹⁾	7,5	16	14,0	14,0	28	20	8,0	11,8	12,5	10000	1370 I 1060 II	630 I 140 II	0,024
DR 1625-0958 351¹⁾	7,5	16	13,6	13,5	50	25	17,0	20,5	15,0	10000	1370 I 1060 II	630 I 140 II	0,035
DR 1922-0958 601¹⁾	9,0	19	17	17	34,0	22	12,0	16,3	13,5	10000	2080 I 1630 II	1000 I 232 II	0,035
DR 1922 -0958 651¹⁾	9,0	19	17	17	42,0	22	20,0	24,3	13,5	10000	2080 I 1630 II	1000 I 232 II	0,041

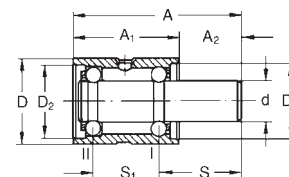
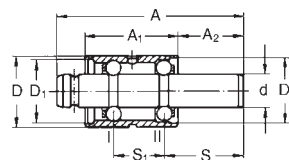
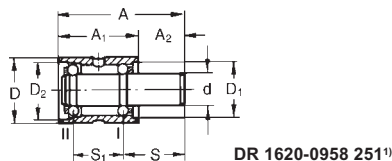
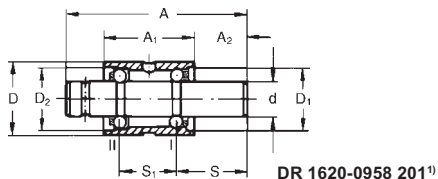

¹⁾ Delivery ex works greased and without end cover.

Limits for stud dia. d: 0/-0,01 mm
Limits for outer ring dia. D: 0/-0,01mm
Designation I/II = different raceway shapes

**Textile machinery
General engineering
applications**

TEXParts Draw-off rollers with cots CK and ZL

Application

Draw-off roller with cot for rotor spinning frames, winders and for general engineering application in textile machines.

Types Ref.no.	Cot ¹⁾	Dimensions in mm				A	A ₁	A ₂	Load fig. in N		Weight kg	Remarks
		d	D	D ₁	D ₂				C	C ₀		
CK 12-1250 611	-	7,0	19	-	-	18,2	11	3,6	2550	680	0,020	basic bearing unit for CK 12-0030 848
CK 12-0030 848	J-490 A	7,0	28	19	15,2	18,3	11	3,6	2550	680	0,028	
CK 12-1248 719	HA 80	7,0	28	19	16,1	18,3	11	3,6	2550	680	0,028	
ZL 20-1250 392	890 A-L	10,0	45	30	-	18,0	9,0	4,3	5070	2360	0,050	rubber seal running in contact with inner ring
ZL 20-1252 714	890 A-L	10,0	45	30	-	18,0	9,0	4,3	5070	2360	0,050	metal seal
ZL 20-1256 486	121 A-L	10,0	45	30	-	18,0	9,0	4,3	5070	2360	0,050	

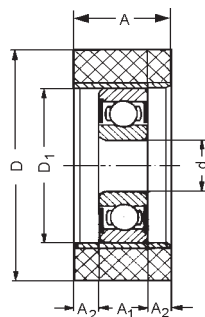

ZL 20-1250 392
ZL 20-1252 714
ZL 20-1256 486

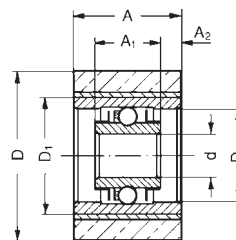

CK 12-0030 848
CK 12-1248 719

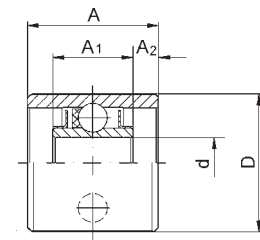

CK 12-1250 611

¹⁾ Other cots available on request.

Top rollers LP	1
Top roller lubricating equipment	
Top rollers series LP 1002	2
Top rollers series LP 1002	3
Top rollers series LP 1003	4
Top rollers series LP 1014	5
Top rollers series LP 1015	6
Top rollers series LP 1016, 1017	7
Top rollers series LP 302 with special shape of saddle	8
Top rollers series LP 302 with special shape of saddle	9
Lubricating equipment and accessories	10
Grease guns	



TEXParts Top rollers series LP 1002

Application

Top roller for use as front and rear top roller.
If requested top rollers can also be supplied as apron top roller with cot - depending on gauge and top apron cradle OH.

Cotton ring frames with weighting arms PK 3025, PK 3035, PK 2025, PK 2035, PK 2055 and PK 2065.

All top rollers in this chapter are without cot.
For cot dimensions see chapter 9 page 87.

If desired TEXParts will supply top rollers with ready ground cots. Cot quality can be determined by the customer himself.

Top roller load:
25 daN

Ring frames

Cotton mills

Chapter 3-2

Types Ref.no.	Gauge Tw in mm	Dimension in mm Y	Colour of end cover
LP 1002-1249 324	68.4	98.4	blue
LP 1002-1248 379	75	105	blue
LP 1002-1248 382	82.5	112,5	blue
LP 1002-1256 898	90	120	blue
LP 1002-0956 274	100	130	blue

End cover (included in standard supply)
LPDE -1260 210 (blue)

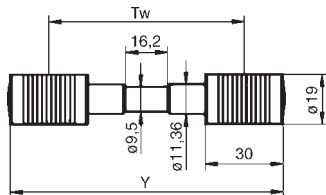

TEXParts Top rollers series LP 1002



Types Ref.no.	Gauge Tw in mm	Dimension in mm Y	Colour of end cover
LP 1002-1248 601	75	109	blue
LP 1002-1256 896	82.5	116.5	blue

End cover (included in standard supply)
LPDE -1260 210 (blue)

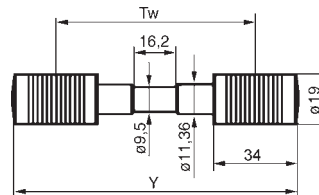

Application

Top roller for use as apron top roller with cot for apron width 32 mm preferably.

Cotton ring frames with weighting arms PK 3025, PK 3035, PK 2025, PK 2035, PK 2055 and PK 2065.

All top rollers in this chapter are without cot.
For cot dimensions see chapter 9 page 88.

If desired TEXParts will supply top rollers with ready ground cots. Cot quality can be determined by the customer himself.

Top roller load:
25 daN

Ring frames

Cotton mills

Chapter 3-3



TEXParts
Top rollers
series LP 1003, LP 303

Application

LP 1003:
 Top roller with special sleeves for use as apron top roller.

Cotton ring frames with weighting arms PK 3025, PK 3035, PK 2025, PK 2035, PK 2055 and PK 2065.

To be used without cots.

Top roller load:
 25 daN

Ring frames

Cotton mills

Chapter 3-4

Types Ref.no.	Gauge Tw in mm	Dimension in mm Y	Colour of end cover
LP 1003-1256 596	68.4	98.4	blue
LP 1003-1256 597	75	105	blue
LP 1003-1256 598	82.5	112.5	blue
LP 1003-1256 599	90	120	blue

End cover (included in standard supply)
LPDE -1260 210 (blue)

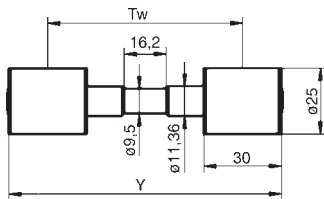

TEXParts
Top rollers
series LP 1014



Types Ref.no.	Gauge Tw in mm	Dimens. in mm Y	Colour of end cover
LP 1014-1253 740 ¹⁾²⁾	75	109	blue
LP 1014-1253 741 ¹⁾	82,5	116,5	blue
LP 1014-1253 742 ¹⁾	90	124	blue
LP 1014-0025 222 ¹⁾³⁾	100	134	blue

End cover (included in standard supply)
LPDE -1260 210 (blue)

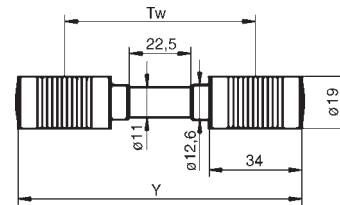

In worsted ring frames with PK 6000 weighting arm:

- ¹⁾ Top roller for use as front and rear top roller.
- ²⁾ LP 1014-1253 740 for use as apron top roller.
- ³⁾ Delivery until using-up of stock.

Application

Top roller for use as front and rear top roller.

Worsted ring frames with weighting arms of series PK 6000 and PK 1601

All top rollers in this chapter are without cot. For cot dimensions see chapter 9 page 87.

Top roller load:
 35 daN

Ring frames

Worsted mills
Cotton mills

Chapter 3-5



TEXParts Top rollers series LP 1015

Application

Top roller for use as front and rear top roller.

Cotton speed frames with PK 5000, PK 1500, PK 1600 weighting arms.

All top rollers in this chapter are without cot. For cot dimensions see chapter 9 page 87.

Top roller load:
35 daN

Ring frames
Cotton speed frames

Cotton mills
Worsted mills

Chapter 3-6

Types Ref.no.	Gauge Tw in mm	Dimension in mm Y	Colour of end cover
LP 1015-1253 744 ¹⁾	82,5	122.5	blue
LP 1015-1253 745 ¹⁾	90	130	blue
LP 1015-0025 227	100	140	blue
LP 1015-0025 228	110	150	blue
LP 1015-0025 229	130	170	blue

End cover (included in standard supply)

LPDE -1260 210 (blue)

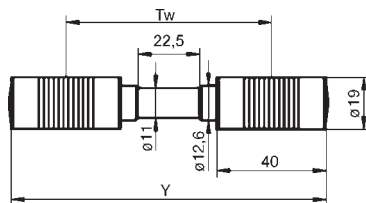

In worsted ring frames with PK 6000 weighting arm:

¹⁾ For use as apron top roller

TEXParts Top rollers series LP 1016, 1017



Types Ref.no.	Gauge Tw in mm	Dimension in mm Y	Dimension E	Colour of end cover
LP 1016-1256 711	75	109	34	blue
LP 1017-1256 712	82.5	122.5	40	blue
LP 1017-1256 713	90	130	40	blue
LP 1017-0013 010	100	140	40	blue
LP 1017-0013 011	110	150	40	blue
LP 1017-0013 012	130	170	40	blue

End cover (included in standard supply)

LPDE -1260 210 (blue)

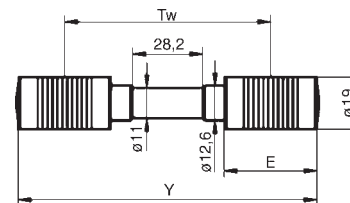

Application

Top roller for use as apron top roller.

Cotton speed frames and worsted ring frames with weighting arms series PK 1500, PK 1601.

All top rollers in this chapter are without cot. For cot dimensions see chapter 9 pages 88 and 89.

Top roller load:
35 daN.

Ring frames
Cotton speed frames

Worsted mills
Cotton mills

Chapter 3-7



TEXParts
Top rollers
series LP 302
with special shape of saddle

TEXParts
Top rollers
series LP 302
with special shape of saddle



Application

Top roller for use as front and rear top roller for Rieter draft systems in cotton ring frames.

All top rollers in this chapter are without cot.

Types Ref.no.	Gauge Tw in mm	Dimension in mm Y
LP 302-0019 135	70	100
LP 302-0015 895	75	105
LP 302-0019 136	80	110
LP 302-0019 137	90	120

End cover (included in standard supply)
LPDE -1260 210 (blue)

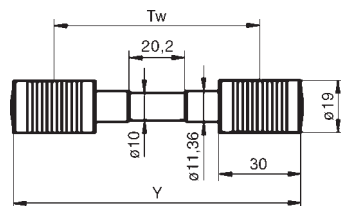

Top roller load:
 25 daN.

Ring frames

Cotton mills

Chapter 3-8

Types Ref.no.	Gauge w in mm	Dimension in mm Y
LP 302-0010 014	70	104
LP 302-0010 015	75	109
LP 302-0010 011	80	114
LP 302-0010 016	90	124

End cover (included in standard supply)
LPDE -1260 210 (blue)

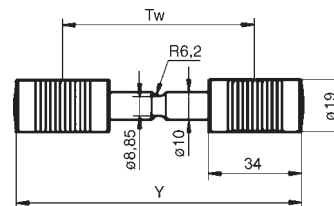

Application

Top roller for use as front and rear top roller as well as apron top roller with cot for Rieter draft systems in cotton ring frames.

All top rollers in this chapter are without cot.

Top roller load:
 25 daN.

Ring frames

Cotton mills

Chapter 3-9



TEXParts Lubricating equipment and accessories Grease guns

Application

For lubricating small numbers of top rollers.

As regards lubrication of bottom roller bearings see chapter 4 page 10.

Item	Types	Ref.no.
Grease guns¹⁾		
Size 2	Contents 120 cm ³	0993 073
Size 3	Contents 340 cm ³	0993 091
For top roller types		
LP 1002	↕ 0968 903	
LP 1014, LP 1015,		
LP 1016, LP 1017		



0968 903

**Cotton mills
Worsted mills**

Chapter 3-10

¹⁾For lubrication of top rollers from TEXParts, the nozzle 0968 903, which must be ordered separately, has to be screwed to the grease gun.

Bottom roller bearings	1
Bottom roller bearings UL with locating cap with side lugs	2
Bottom roller bearings with locating cap with central nose	4
Bottom roller bearings UL with locating clip UCL with side lugs	6
Bottom roller bearings UL	8
Special designs	8
Lubricating equipment and Accessories for bottom rollers,	10
Contact roll assemblies and tension pulleys	10



TEXParts Bottom roller bearings UL with locating cap with side lugs



Application

For bottom rollers of draft systems of ring frames and speed frames.

See also chapter 9 page 90.

Types Ref.no.	for roller stand width in mm	Dimensions in mm			L	L ₁	L ₃	Basic load daN dyn. C	Weight kg
		d	D	D ₁ ¹⁾					
UL 28-0000 416	20	16,5	28	23,90	19	23	20,2	865	0,060
UL 28-0000 417	22	16,5	28	23,90	19	23	22,2	865	0,060
UL 28-0000 418	24	16,5	28	23,90	19	23	24,2	865	0,060
UL 28-0010 047	26	16,5	28	23,90	19	23	26,2	865	0,058
UL 28-0010 080 ²⁾³⁾	22	16,5	28	23,90	23	23	22,2	865	0,066
UL 28-0010 083 ²⁾³⁾	24	16,5	28	23,90	23	23	24,2	865	0,066
UL 30-0026 220	22	16	30	23,90	26	22	22,2	830	0,084
UL 30-0021 106	26	17	30	25,40	19	22	26,2	830	0,072
UL 30-0018 195	26	18,5	30	25,40	19	22	26,2	830	0,065
UL 30-0002 610	22	18,5	30	25,40	19	22	22,2	830	0,065
UL 32-0000 421	22	19	32	26,90	20	24	22,2	1020	0,081
UL 32-0000 422	24	19	32	26,90	20	24	24,2	1020	0,081
UL 32-0000 423	25	19	32	26,90	20	24	25,2	1020	0,081
UL 32-0012 499	26	19	32	26,90	20	24	26,2	1020	0,081
UL 36-0000 424	22	19	36	29,90	22	26	22,2	1180	0,125
UL 36-0000 425	24	19	36	29,90	22	26	24,2	1180	0,125
UL 36-0000 426	25	19	36	29,90	22	26	25,2	1180	0,125
UL 36-0028 421	20	21	36	29,90	22	26	20,2	1180	0,112
UL 36-1248 201 ³⁾	24	21	36	29,90	22	26	24,2	1180	0,117
UL 40-0021 786	20	23	40	33,90	23,5	27	20,2	1430	0,148

Locating cap

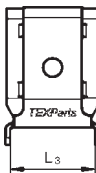

Ring frames
Speed frames

Cotton mills
Worsted mills

- ¹⁾ D₁= collar diameter of inner ring.
²⁾ Execution with extended inner ring.
³⁾ Delivery until using-up of stock.

Standard lubricating nipple

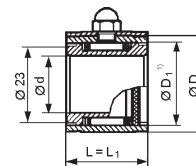
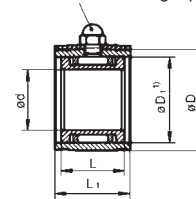

UL 28-0010 080²⁾
UL 28-0010 083²⁾

Standard lubricating nipple

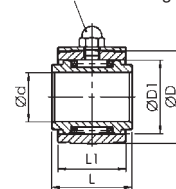

UL 30-0026 220



TEXParts Bottom roller bearings with locating cap with central nose



Application

For bottom rollers of draft systems of ring frames and speed frames.

See also chapter 9 page 90.

Types Ref.no.	Dimensions in mm				D ₁ ⁵⁾	L	L ₁	N	Basic load daN dyn.C	Weight kg
	d	D	K							
UL 28-0003 590	16,5	28	-		23,90	19	23	5,9	865	0,059
UL 30-0007 871 ¹⁾	18,5	30	-		25,40	19	22	5,9	830	0,065
UL 30-0003 665 ¹⁾	18,5	30	-		25,40	19	22	5,9	830	0,065
UL 30-0028 276 ²⁾	18,5	30	-		25,40	19	22	5,9	830	0,064
UL 32-0013 400	19	32	-		26,90	20	24	5,9	1020	0,079
UL 32-0015 143 ³⁾	19	32	-		26,90	20	24	5,9	1020	0,079
UL 32-0016 548	21	32	-		27,85	19	23	5,9	935	0,068
UL 32-0019 169	18,5	32	-		27,85	19	22	5,9	935	0,100
UL 32-0023 114 ⁴⁾	16,295	32	32,5		26,90	17	20	5,9	850	0,100
UL 36-0014 782	18,5	36	-		29,90	19	22	5,9	1180	0,107
UL 36-0016 442	21	36	-		29,90	22	26	5,9	1180	0,125
UL 40-0025 408 ⁴⁾	23	40	40,5		32,85	21	24	5,9	1275	0,135

¹⁾ Different tolerances of bore diameter.

²⁾ Bearing with funnel lubricating nipple.

³⁾ This bearing is delivered ex works without lubricant. Bearing with safety bow.

⁴⁾ Bearing with special locating cap.

⁵⁾ D₁ = collar diameter of inner ring.

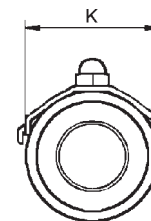
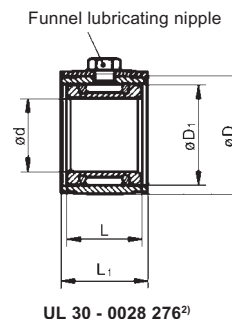
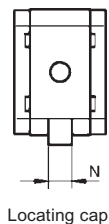
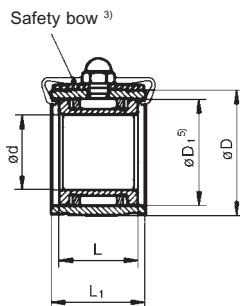

Ring frames
Speed frames

Cotton mills
Worsted mills

UL 32 -0023 114⁴⁾
UL 40 -0025 408⁴⁾



TEXParts Bottom roller bearings UL with locating clip UCL with side lugs



Application

For bottom rollers of draft systems of ring frames and speed frames.

See also chapter 9 page 90.

For the application of bottom roller bearings with side lugs, the standard types with locating cap (see chapter 4 page 2) should be used if bearing dimensions are identical.

Types Ref.no.	Dimensions in mm			L	L ₁	K	Basic load daN dyn. C	Weight kg	Remarks
	d	D	D ₁ ¹⁾						
UL 28-0959 274	14,2	28	23,90	16,6	23	-	720	0,073	One locating clip to be used with each bottom roller bearing. Size L ₃ of clip depends on width of roller stand. If bottom rollers are ordered, the locating clip according to the required stand width must be ordered separately.
UL 28-0959 263	16,5	28	23,90	19	23	-	865	0,063	
UL 32-0959 261	16,2	32	26,90	19,7	24	-	1020	0,153	
UL 32-0959 262	19	32	26,90	20	24	-	1020	0,095	
UL 36-0959 265	19	36	29,90	22	26	-	1180	0,104	
UL 45-0959 268	25	45	36,90	25	29	-	1760	0,239	

Locating clip Ref.no.	for roller stand width mm	L ₃
UCL-0964 125	20	20,2
UCL-0964 126	22	22,2
UCL-0964 129	24	24,2
UCL-0964 127	25	25,2
UCL-0964 136	26	26,2
UCL-0964 128	30	30,2

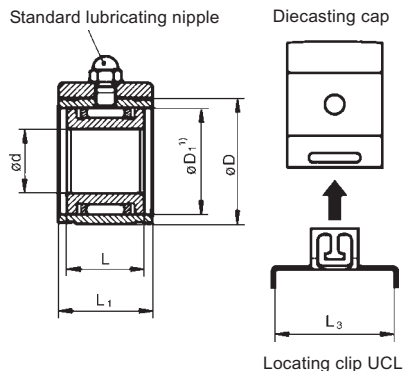

¹⁾ D₁=collar diameter of inner ring.

Ring frames
Speed frames

Cotton mills
Worsted mills



TEXParts Bottom roller bearings UL Special designs



Application

For bottom rollers of ring frames and draw frames.

See also chapter 9 page 90.

Types Ref.no.	Dimensions in mm				L	L ₁	N	Basic load daN dyn. C	Weight kg
	d	D	D ₁ ¹⁾	d ₁ ²⁾					
UL 32-0017 390 ³⁾	21	32	27,85	-	19	23	-	935	0,060
UL 32-0036 128	-	32	-	24	-	22	5,9	935	0,053
UL 28-1259 366	16,5	28	23,9	-	19	22	-	935	0,050

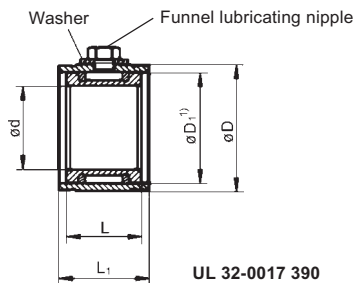

Locating cap

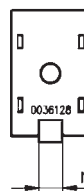

Standard lubricating nipple

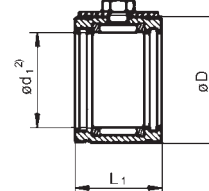

UL 32-0036 128

Ring frames
Draw frames

Cotton mills

Chapter 4-8

- ¹⁾ D₁ = collar diameter of inner ring.
²⁾ d₁ = Inside diameter of the needle complement.
³⁾ Delivery until using-up of stock.

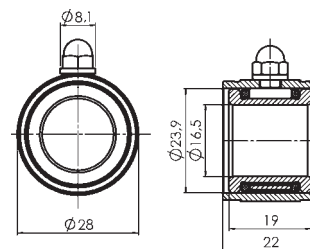

UL 28-1259 366

Chapter 4-9



TEXParts Lubricating equipment and Accessories for bottom rollers, Contact roll assemblies and Tension pulleys

Application

For lubricating all types of TEXParts bottom roller bearings, for lubricating contact roll assemblies and tension pulleys.

As regards lubrication of top rollers see chapter 8 page 15.

All nozzles mentioned are **not** included in the standard supply of the grease guns and have to be ordered as separate item.

Item	Types Ref.no.	Nozzle Ref.no.
Grease guns		
Size 2 Contents 120 cm ³	0993 073	
Size 3 Contents 340 cm ³	0993 091	
For bottom roller bearings		
UL with TEXParts standard lubricating nozzle		0993 040
UL with funnel lubricating nozzle		0026 714
For contact roll assemblies		
AR 28		0993 040¹⁾
AR 28		1253 413²⁾
AR 45		0017 198²⁾
AR 3528		0017 198²⁾
AR 5047		0017 198²⁾
AR 50		0017 199²⁾
AR 5024		0017 199²⁾
For tension pulleys		
SR 7		0026 714
SR 9		0026 714
SR 23		0993 040
SR 28		0993 040
SR 5047		0017 198²⁾

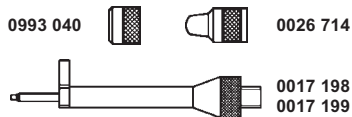

¹⁾ Lubrication from top

²⁾ Lubrication from front

**Cotton mills
Worsted mills**

Weighting arms with equipment and draft system data	1	Top apron cradles OH 2022	34
Top apron cradle, condensers, distance clips, setting tools, pneumatic accessories		Top apron cradles OH 62	36
Weighting arms PK 3025, PK 3035	2	Top apron cradles OH 2042	38
Pneumatic load principle		Top apron cradles OH 132	40
Weighting arms PK 3000	4	Top apron cradles OH 1225	42
Equipment and draft system data Cotton ring frames		Top apron cradles OH 122	44
Weighting arms PK 2025, PK 2035	6	Top apron cradles OH 5022	46
Weighting arms PK 2025, PK 2035	8	Top apron cradles OH 514	48
Equipment and draft system data Cotton ring frames		Top apron cradles OH 5042	50
Weighting arms PK 2055, PK 2065	10	Top apron cradles OH 534	52
Weighting arms PK 2055, PK 2065	12	Top apron cradles OH 5245	54
Equipment and draft system data Cotton ring frames		Top apron cradles OH 524	56
Weighting arms PK 5000	14	Top apron cradles OH 2402	58
Weighting arms PK 5000	16	Top apron cradles OH 554	60
Equipment and draft system data Cotton speed frames		Top apron cradles OH 6022	62
Weighting arms PK 5000	18	Bottom apron nose bar	64
Equipment and draft system data Cotton speed frames		Bottom apron nose bar	65
Weighting arms PK 1500	20	Roving guides, condensers	66
Equipment and draft system data Cotton speed frames		Roving guides, condensers	68
Weighting arms PK 1500	22	Roving guides, condensers	70
Equipment and draft system data Cotton speed frames		Distance clips OLC	72
Weighting arms PK 1500	24	Distance clips OLC	73
Equipment and draft system data Cotton speed frames		Setting tools	74
Weighting arm PK 6000	26	Setting tools	75
Weighting arm PK 6000	28	Setting tools	76
Equipment and draft system data Worsted ring frames		Setting tools	77
Weighting arms PK 1601	30	Setting tools	78
Weighting arms PK 1601	32	Setting tools	79
Equipment and draft system data Worsted ring frames		Pneumatic accessories for PK 3000	80
		Pneumatic accessories for PK 5000 and PK 6000	81



TEXParts Weighting arms PK 3025, PK 3035 Pneumatic load principle



Application

Ring frame 3-roller-
double apron draft system
PK 3025-1257 300.

With top apron cradle
OH 2022 for cotton
fibres, synthetics
up to 45 mm, and
corresponding blends.

With cradle OH 2042 for
very long cotton fibres
and synthetics of poor draft
properties up to 54 mm.

With the cradle OH 1225
for synthetics up to
approx. 60 mm.

PK 3035-1259 710 as
well as PK 3025-1257 300,
specially for longer fibre
ranges.

See as well chapter 9
page 18.

Ring frames

Cotton mills

Chapter 5-2

Types			PK 3025-1257 300 ¹⁾	PK 3035-1259 710 ¹⁾³⁾
Ref.no.				
Load on top roller [daN]			Operating pressure [bar]	
Front 1	Middle 2	Rear 3	1,5 bar	standard application range
11,5	10	11,5	3,0 bar	extended application range*
20,5	16	20,5	4,0 bar	
25	19,5	25		

*) The possibility to utilize the "extended application range" has to be discussed with OEM.

Top roller for PK 3025 Ø mm²⁾:
Front 1 28 Middle 2 25 Rear 3 28

Top roller for PK 3035 Ø mm²⁾:
Front 1 35 Middle 2 25 Rear 3 35

Front clearer roller holder
Ref.No. 1258 593

Front clearer roller
Ref.No.
1259 669
1259 669
1253 433

Gauge TW
in mm
68,4
75
82,5

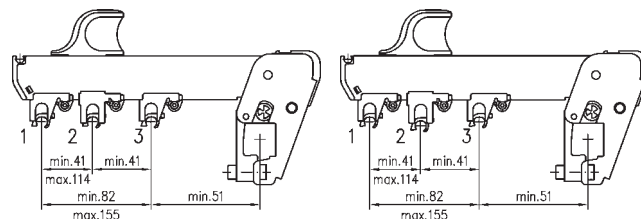
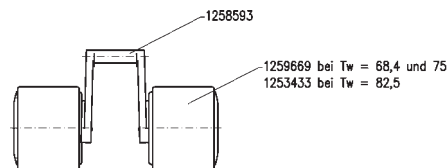

PK 3025-1257 300

PK 3035-1259 710

Measurements are shown in mm

¹⁾ Pneumatic loading; air pressure require.

²⁾ Dia. values refer to newly covered top rollers.

³⁾ In the case of PK 3035 the middle guide element is 3,5 mm longer than on the PK 3025 (middle guide element Ref.No 1259 709)

⁴⁾ Air pressure is limited to a maximum of 3 bar.



TEXParts

Weighting arms PK 3000

Equipment and draft system data

Cotton ring frames



Equipment for weighting arms PK 3025-1257 300 and PK 3035-1259 710
(Equipment is not included in delivery volume of weighting arm)

Gauge TW in mm	Top apron cradle OH	Apron	Top roller ¹⁾ (without cot) Ref.no.	Position in weighting arm ²⁾
Front and rear top roller:				
68,4			LP 1002-1249 324	1/ 3
75			LP 1002-1248 379	1/ 3
82,5			LP 1002-1248 382	1/ 3
90			LP 1002-1256 898	1/ 3
Top apron cradle, apron and apron top roller (LP 1003 * with special sleeve as standard):				
68,4	OH 2022-1247 888 (OH short)	PR 28-0998 113	LP 1003-1256 596*	2
	OH 2042-1250 133 (OH medium)	PR 2813-1251 565	LP 1002-1249 324	
	OH 1225-6001 674 ²⁾ (OH long)	PR 028-0002 484		
75	OH 2022-1247 887 (OH short)	PR 28-0998 113	LP 1003-1256 597*	2
	OH 2042-1250 134 (OH medium)	PR 2813-1251 565	LP 1002-1248 379	
	OH 1225-6001 675 ²⁾ (OH long)	PR 032-0002 485	LP 1003-1256 598*	
82,5	OH 2022-1247 889 (OH short)	PR 28-0998 113	LP 1002-1248 382	2
Top apron cradle, apron and apron top roller Apron top roller LP 1002 with cot or LP 1003 with special sleeve				
75	OH 1225-6001 257 ²⁾ (OH long)	PR 032-0002 485	LP 1002-1248 601 LP 1003-1256 597	2
82,5	OH 1225-6001 675 ²⁾ (OH long)	PR 032-0002 485	LP 1002-1256 896 LP 1003-1256 598	2

¹⁾ Ref.Nos. mentioned are for top rollers without cots.
Cot quality according to customers' request.

²⁾ Available on request.

³⁾ Position in weighting arm: 1 = Front
(see fig. on next page) 2 = Middle
3 = Rear

Draft system setting

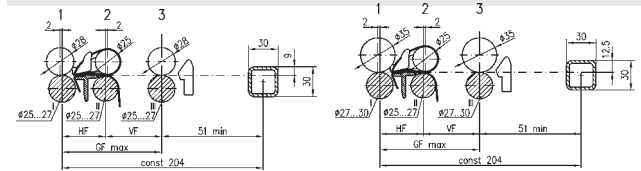

PK 3025-1257 300

PK 3035-1259 710

Draft field settings and max. fibre length

Weighting arm PK	Top apron cradle OH	Field distances in mm			GF mm max.	Max. fibre length mm
		HF	VF min.	VF usual ⁴⁾		
PK 3025	OH 2022	44	41	4)	153	45
	OH 2042	53	41	4)	153	54
	OH 1225	68	41	4)	153	60
PK 3035	OH 2022	46	41	4)	153	45
	OH 2042	55	41	4)	153	54
	OH 1225	70	41	4)	153	60

Clips

For OH 2022	OLC-0964 118 yellow	OLC-0017 705 lilac	OLC-0964 119 white
For OH 2042	OLC-0964 117 red	OLC-0964 118 yellow	OLC-0964 119 white
For OH 1225	OLC-0964 118 yellow	OLC-0964 119 white	OLC-0017 627 grey

Bottom roller diameter in mm: ⁵⁾	PK 3025	Front I	25...27	PK 3035	Front I	27...30				
							Middle II	25...27	Middle II	25...27
							Rear III	25...27	Rear III	27...30

Remarks

⁴⁾ The distances VF depends on the fibre to be spun, length of fibre and roving twist.

⁵⁾ Diameters shown for bottom rollers are mere reference values



TEXParts

Weighting arms PK 2025, PK 2035



Application

Ring frame 3-roller-double apron draft system
PK 2025-1251 331,

With top apron cradle
OH 2022/OH 62 for
cotton fibres, synthetics
up to 45 mm, and
corresponding blends.

With cradle OH 2042/
OH 132 for very
long cotton fibres and
synthetics of poor draft
properties up to 54 mm.
Blends of those fibres.

With the cradle OH 122
for synthetics up to
approx. 60 mm.

PK 2035-1251 784 as
well as PK 2025-1251 331,
specially for longer
fibre ranges.

See as well chapter 9
page 28.

Types Ref.no.	Loads in daN	For top roller Ø mm ¹⁾
PK 2025-1251 331	Front 1 6 ²⁾ 10 14 18 28	
	Middle 2 10 14 - 25	
	Rear 3 12 16 - 28	
PK 2035-1251 784	Front 1 6 ²⁾ 10 14 18 35	
	Middle 2 10 14 - 25	
	Rear 3 12 16 - 35	

Front Clearer Roller ³⁾ Ref. no.	Gauge Tw in mm
1252 741	68.4
1247 968	75
1247 967	82.5

Clearer roller holders
face of arm
Ref.no.

PFE-0908 212

PFE-0908 212

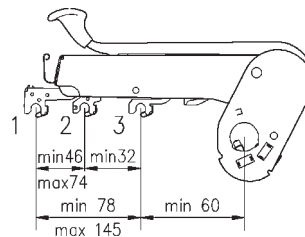

PK 2025-1251 331

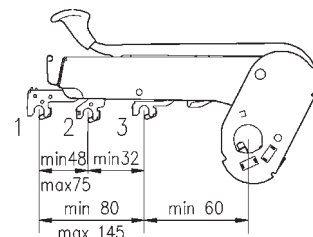

PK 2035-1251 784

Measurements are shown in mm.

Ring frames

Cotton mills

¹⁾ Diameter values refer to newly covered top rollers.

²⁾ Partial load relieve

³⁾ Colour of roller: blue with grey flocking



TEXParts Weighting arms PK 2025, PK 2035 Equipment and draft system data Cotton ring frames



Equipment for weighting arms PK 2025-1251 331 and PK 2035-1251 784
(Equipment is not included in delivery volume of weighting arm)

Gauge TW in mm	Top apron cradle OH	Apron	Top roller ¹⁾ (without cot) Ref.no.	Position in weighting arm ²⁾
Front and rear top roller:				
68,4			LP 1002-1249 324	1/ 3
75			LP 1002-1248 379	1/ 3
82,5			LP 1002-1248 382	1/ 3
90			LP 1002-1256 898	1/ 3
Top apron cradle, apron and apron top roller (LP 1003* with special sleeve as standard version):				
68,4	OH 2022-1247 888 (OH short)	PR 28-0998 113	LP 1003-1256 596* LP 1002-1249 324	2
	OH 2042-1250 133 (OH medium)	PR 2813-1251 565		
	OH 132-0963 700 (OH medium)			
	OH 122-0963 495 (OH long)	PR 028-0002 484		
75	OH 2022-1247 887 (OH short)	PR 28-0998 113	LP 1003-1256 597* LP 1002-1248 379	2
	OH 2042-1250 134 (OH medium)	PR 2813-1251 565		
82,5	OH 2022-1247 889 (OH short)	PR 28-0998 113	LP 1003-1256 598* LP 1002-1248 382	2
Top apron cradle, apron and apron top roller (LP 1002 with cot or LP 1003 with special sleeve)				
75	OH 132-0963 660 (OH medium)	PR 323-0998 232	LP 1002-1248 601 LP 1003-1256 597	2
	OH 122-0963 500 (OH long)	PR 032-0002 485		
82,5	OH 132-0963 671 (OH medium)	PR 323-0998 232	LP 1002-1256 896 LP 1003-1256 598	2
	OH 122-0963 511 (OH long)	PR 032-0002 485		
90	OH 62-0962 841 (OH short)	PR 32-0997 533	LP 1002-1256 897	2

¹⁾ Ref. Nos. mentioned are for top rollers without cots.
Cot quality according to customers' request.

²⁾ Position in weighting arm: 1 = Front
(see fig. on next page) 2 = Middle
3 = Rear

Draft system setting

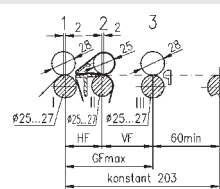

PK 2025-1251 331

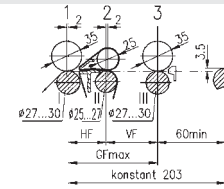

PK 2035-1251 784

Draft field settings and max. fibre length

Weighting arm PK	Top apron cradle OH	Field distances in mm			Max. fibre length mm
		HF	VF min.	VF usual ³⁾	
PK 2025-1251 331	OH 2022/OH 62	44	34	³⁾	143
	OH 2042/OH 132	53	34	³⁾	143
	OH 122	68	34	³⁾	143
PK 2035-1251 784	OH 2022/OH 62	46	34	³⁾	143
	OH 2042/OH 132	55	34	³⁾	143
	OH 122	70	34	³⁾	143

Clips

For OH 2022/OH 62 OLC-0964 118 yellow OLC-0017 705 lilac OLC-0964 119 white
For OH 2042/OH 132 OLC-0964 117 red OLC-0964 118 yellow OLC-0964 119 white
For OH 122 OLC-0964 118 yellow OLC-0964 119 white OLC-0017 627 grey

Bottom roller diameter in mm: ⁴⁾	PK 2025	Front	I	25...27	PK 2035	Front	I	27...30
Rear III	25...27	Rear III	27...30					

Remarks

³⁾ The distances VF depends on the fibre to be spun, length of fibre and roving twist.

⁴⁾ Diameters shown for bottom rollers are mere reference values



TEXParts Weighting arms PK 2055, PK 2065



Application
Ring frame 3-roller
double apron draft system
PK 2055-1251785.

With top apron cradle
OH 2022/OH 62 for
cottons, synthetics up
to approx. 45 mm.
Blends of both types.

With cradle OH 2042/
OH 132 for very long
cotton fibres and syn-
thetics of about 54 mm
of poor draft properties.
Blends of both types.

With cradle OH 122 for
synthetics up to approx.
60 mm.

PK 2065-1251 786 as
PK 2055-1251 785,
specially for longer fibre
range.

See as well chapter 9
page 28.

Types Ref.no.	Loads in daN	For top roller Ø mm ¹⁾
PK 2055-1251 785	Front 1 6 ²⁾ 10 14 18 28	28
	Middle 2 10 14 - 25	25
	Rear 3 18 - - 28	28
PK 2065-1251 786	Front 1 6 ²⁾ 10 14 18 35	35
	Middle 2 10 14 - 25	25
	Rear 3 18 - - 35	35
Front Clearer Roller ³⁾ Ref. no.	Gauge Tw in mm	
1252 741	68.4	
1247 968	75	
1247 967	82.5	

Clearer roller holders
face of arm
Ref.no.

PFE-0908 212

PFE-0908 212

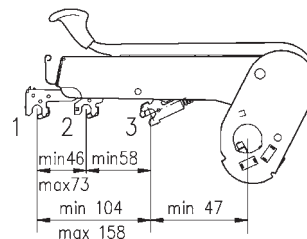

PK 2055-1251 785

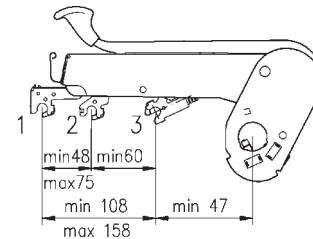

PK 2065-1251 786

Measurements are shown in mm.

¹⁾ Dia. values refer to newly covered top rollers.

²⁾ Partial load relieve

³⁾ Colour of roller: blue with grey flocking

Ring frames

Cotton mills



TEXParts Weighting arms PK 2055, PK 2065 Equipment and draft system data Cotton ring frames



Equipment for weighting arms PK 2055-1251 785 and PK 2065-1251 786
(Equipment is not included in delivery volume of weighting arm)

Gauge TW in mm	Top apron cradle OH	Apron	Top roller ¹⁾ (without cot) Ref.no.	Position in weighting arm ²⁾
Front and rear top roller:				
68,4			LP 1002-1249 324	1/ 3
75			LP 1002-1248 379	1/ 3
82,5			LP 1002-1248 382	1/ 3
90			LP 1002-1256 898	1/ 3
Top apron cradle, apron and apron top roller (LP 1003* with special sleeve as standard version):				
68,4	OH 2022-1247 888 (OH short)	PR 28-0998 113	LP 1003-1256 596* LP 1002-1249 324	2
	OH 2042-1250 133 (OH medium)	PR 2813-1251 565		
	OH 132-0963 700 (OH medium)			
	OH 122-0963 495 (OH long)	PR 028-0002 484		
75	OH 2022-1247 887 (OH short)	PR 28-0998 113	LP 1003-1256 597* LP 1002-1248 379	2
	OH 2042-1250 134 (OH medium)	PR 2813-1251 565		
82,5	OH 2022-1247 889 (OH short)	PR 28-0998 113	LP 1003-1256 598* LP 1002-1248 382	2
Top apron cradle, apron and apron top roller (LP 1003* with special sleeve)				
75	OH 132-0963 660 (OH medium)	PR 323-0998 232	LP 1002-1248 601 LP 1003-1256 597	2
	OH 122-0963 500 (OH long)	PR 032-0002 485		
82,5	OH 132-0963 671 (OH medium)	PR 323-0998 232	LP 1002-1256 896 LP 1003-1256 598	2
	OH 122-0963 511 (OH long)	PR 032-0002 485		
90	OH 62-0962 841 (OH short)	PR 32-0997 533	LP 1002-1256 897	2

¹⁾ Ref. Nos. mentioned are for top rollers without cot.
Cot quality according to customers' request.

²⁾ Position in weighting arm: 1 = Front
(see fig. on next page) 2 = Middle
3 = Rear

Draft system setting

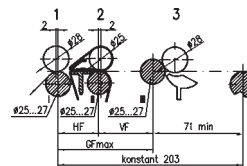

PK 2055-1251 785

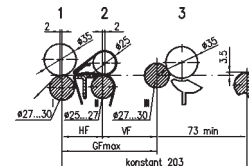

PK 2065-1251 786

Draft field settings and max. fibre length

Weighting arm PK	Top apron cradle OH	Field distances in mm				Max. fibre length mm
		HF min.	VF usual ³⁾	GF mm max.		
PK 2055- 1251 785	OH 2022/OH 62	44	36	³⁾	132	45
	OH 2042/OH 132	53	36	³⁾	132	54
	OH 122	68	36	³⁾	132	60
PK 2065- 1251 786	OH 2022/OH 62	46	36	³⁾	132	45
	OH 2042/OH 132	55	36	³⁾	132	54
	OH 122	70	36	³⁾	132	60

Clips

For OH 2022/OH 62 OLC-0964 118 yellow OLC-0017 705 lilac OLC-0964 119 white
For OH 2042/OH132 OLC-0964 117 red OLC-0964 118 yellow OLC-0964 119 white
For OH 122 OLC-0964 118 yellow OLC-0964 119 white OLC-0017 627 grey

Bottom roller diameter in mm: ⁴⁾	PK 2055	Front	PK 2065			Front	I	27...30			
			Middle	II	25...27				Middle	II	25...27

Remarks

- ³⁾ The distances VF depends on the fibre to be spun, length of fibre and roving twist.
⁴⁾ Diameters shown for bottom rollers are mere reference values



TEXParts Weighting arms PK 5000



Application

3-roller- and 4-roller double apron draft system for speed frames.

With top apron cradle OH 5022 for cotton and synthetic fibres up to approx. 45 mm length.

With cradle OH 5042 for very long cotton fibres and synthetics of poor draft properties up to 54 mm.

With cradle OH 5245 for synthetics up to approx. 60 mm fibre length.

See as well chapter 9 page 42.

Types Ref.no.	PK 5025-1259 471 ¹⁾ PK 5035-1259 473 ¹⁾		
	Load on top roller (daN)		
Operating pressure	Front 1	Middle 2	Rear 3
from 1,5 bar ↓ up to 4,0 bar	17 ↓ 36	12 ↓ 21	16 ↓ 32
Top roller for PK 5025 Ø mm²⁾:	28	25	28
Top roller for PK 5035 Ø mm²⁾:	35	25	35

Application:
PK 5025-1259 471 as PK 5035-1259 473, specially for longer fibres.

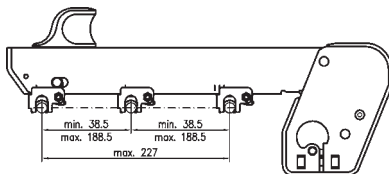

Measurements are given in mm.

- ¹⁾ Pneumatic loading; air pressure require.
- ²⁾ Dia. values refer to newly covered top rollers.

Types Ref.no.	PK 5025-1259 472 ¹⁾³⁾ PK 5035-1259 474 ¹⁾³⁾			
	Load on top roller (daN)			
Operating pressure	Front 1	Middle 1	Middle 2	Rear 3
from 1,5 bar ↓ up to 4,0 bar	10 ↓ 20	15 ↓ 31	10 ↓ 20	15 ↓ 31
Top roller for PK 5025 Ø mm²⁾:	28	28	25	28
Top roller for PK 5035 Ø mm²⁾³⁾:	35	35	25	35

Application:
PK 5025-1259 472, with top apron cradle OH 5022 for fibres up to approx. 45 mm.

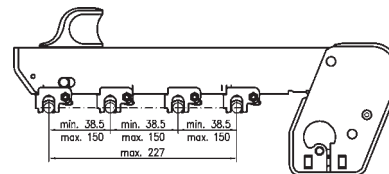

Measurements are given in mm.

- ¹⁾ Pneumatic loading; air pressure require.
- ²⁾ Dia. values refer to newly covered top rollers.
- ³⁾ Available on request.

Speed frames

Cotton mills



TEXParts

Weighting arms PK 5000

Equipment and draft system data

Cotton speed frames



Equipment for weighting arms PK 5025-1259 471 and PK 5035-1259 473

(Equipment is not included in delivery volume of weighting arm)

Gauge TW in mm	Top apron cradle OH	Apron	Top roller ¹⁾ (without cot) Ref.no.	Position in weighting arm ³⁾
Front and rear top roller:				
110			LP1015-0025 228	1/ 3
Top apron cradle, apron and apron top roller with cot (aprons for top roller Ø 25 mm):				
110	OH 5022-1259 297 (OH short)	PR 40-0997 575	LP 1015-0025 228	2
	OH 5042-1259 506 (OH medium)	PR 4010-0002 503	LP 1015-0025 228	2
	OH 5245-1250 370 (OH long)	PR 4011-0002 504	LP 1015-0025 228	2

Draft system setting

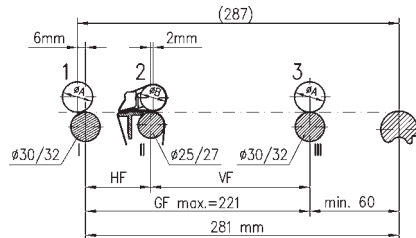

	Top roller Ø in mm	
	Ø A	Ø B
PK 5025	28	25
PK 5035	35	25

Measurements are given in mm.

- Ref.Nos. mentioned are for top rollers without cots.
Cot quality according to customers' request.
- Position in weighting arm: 1 = Front 1
(see fig. above) 2 = Middle 2
3 = Rear 3

Draft field settings and max. fibre length

Weighting arm PK	Top apron cradle OH	Field distances in mm			Max.fibre length mm
		HF	VF min.	VF usual ³⁾	
PK 5025-1259 471	OH 5022	49	40,5 ³⁾	221	45
	OH 5042	60	40,5 ³⁾	221	54
	OH 5245	76	40,5 ³⁾	221	60
PK 5035-1259 473	OH 5022	49	40,5 ³⁾	221	45
	OH 5042	60	40,5 ³⁾	221	54
	OH 5245	76	40,5 ³⁾	221	60

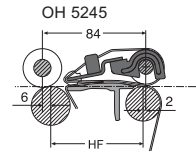
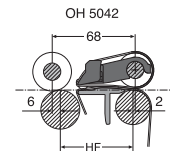
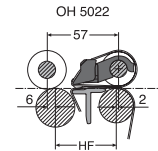

Clips

for OH 5022 ↑
for OH 5042 OLC-0964 104 white, OLC-0964 106 black, OLC-0964 108 green
for OH 5245 ↓

Bottom roller

dia. in mm	Front	Middle	Rear
I	30/32		
II		25/27	
III			30/32

- The distance VF_{usual} depends on the fibre to be spun and fibre length.
The values are gathered in practical use.

TEXParts

Weighting arms PK 5000

Equipment and draft system data

Cotton speed frames



Equipment for weighting arms PK 5025-1259 472 and PK 5035-1259 474 (Equipment is not included in delivery volume of weighting arm)

Gauge TW in mm	Top apron cradle OH	Apron	Top roller ¹⁾ (without cot) Ref.no.	Position in weighting arm ²⁾
Front and rear top roller:				
110			LP1015-0025 228	1/ 2/ 4
Top apron cradle, apron and apron top roller with cot (aprons for top roller Ø 25 mm):				
110	OH 5022-1259 297 (OH short)	PR 40-0997 575	LP 1015-0025 228	3
	OH 5042-1259 506 (OH medium)	PR 4010-0002 503	LP 1015-0025 228	3

Draft system setting

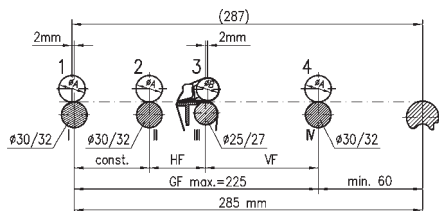

	Top roller Ø in mm	
	Ø A	Ø B
PK 5025	28	25
PK 5035	35	25

Measurements are given in mm.

- Ref.Nos. mentioned are for top rollers without cots. Cot quality according to customers' request.
- Position in weighting arm: 1 = Front 1 (see fig. above)
2 = Middle 2
3 = Middle 3
4 = Rear 4

Draft field settings and max. fibre length

Weighting arm PK	Top apron cradle OH	Field distances in mm				GFmm max.	Fibre length mm
		HF	Con-stant ³⁾	VF min.	VF usual ⁴⁾		
PK 5025-1259 472	OH 5022	49	36,5	40,5 ⁴⁾	225	45	
PK 5025-1259 472	OH 5042	60	36,5	40,5 ^{**}	225	54	
PK 5035-1259 474	OH 5022	49	36,5	40,5 ⁴⁾	225	45	
PK 5035-1259 474	OH 5042	60	36,5	40,5 ^{**}	225	54	

**** Extension of the usability range because of GF_{max} = 225 mm (PK1500; GF_{max} = 195 mm)**

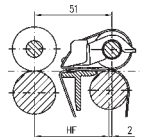

OH 5022

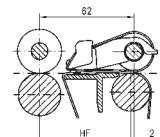

OH 5042

Clips

for OH 5022 ↑
for OH 5042 ↓ OLC-0964 104 white, OLC-0964 106 black, OLC-0964 108 green

Bottom roller

dia. in mm	Front	I	30/32
	Middle	II	30/32
	Middle	III	25/27
	Rear	IV	30/32

- The figure mentioned is the shortest possible distance of the bottom rollers depending on the PK-construction. Enlarged distances depend on the condensers and the field distance setting.
- The distance VF_{usual} depends on the fibre to be spun and fibre length. The values are gathered in practical use.



TEXParts Weighting arms PK 1500



Application

3-roller- and 4-roller double apron draft system for speed frames.

With top apron cradle OH 514 for cotton and synthetic fibres up to approx. 45 mm length.

With cradle OH 534 for very long cotton fibres and synthetics of poor draft properties up to 54 mm.

With cradle OH 524 for synthetics up to approx. 60 mm fibre length.

See as well chapter 9 page 55.

Speed frames

Cotton mills

Chapter 5-20

Types Ref.No.	Loads in daN	For top roller Ø mm
PK 1500-0962 604	Front 1 20 25 30 28	
	Middle 2 10 15 20 25	
	Rear 3 15 20 25 28	
PK 1500-0962 602	Front 1 20 25 30 35	
	Middle 2 10 15 20 25	
	Rear 3 15 20 25 35	
PK 1500-0001 938	Front 1 9 12 15 28	
	Middle 2 15 20 25 28	
	Middle 3 10 15 20 25	
	Rear 4 10 15 20 28	

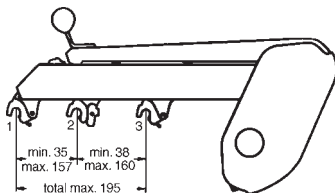

PK 1500-0962 604
PK 1500-0962 602

Measurements are given in mm.

Distances for top roller holders are shown in mm.

Clearer roller holders¹⁾ Front of arm Ref.no.

PFE-0996 685

PFE-0996 685

PFE-0996 685

lateral 2, 3, 4 Ref.no.

PPH-0727 593²⁾

PPH-0727 593²⁾

PPH-0727 593²⁾

Application

PK 1500-0962 602 as PK 1500-0962 604, specially for longer fibres.

PK 1500-0001 938, with top apron cradles OH 514 for fibres up to approx. 45 mm

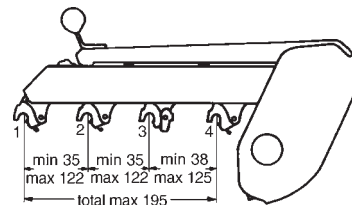

PK 1500-0001 938

Measurements are given in mm.

¹⁾ Clearer roller holders are delivered separately on special order.

²⁾ Can also be used as lateral 1.



TEXParts Weighting arms PK 1500 Equipment and draft system data Cotton speed frames



Equipment for weighting arms PK 1500-0962 604 and PK 1500-0962 602
(Equipment is not included in delivery volume of weighting arm)

Gauge TW in mm	Top apron cradle OH	Apron	Top roller ¹⁾ (without cot) Ref.no.	Position in weighting arm ²⁾
Front and rear top roller:				
100			LP 1015-0025 227	1/ 3
110			LP 1015-0025 228	1/ 3
130			LP 1015-0025 229	1/ 3
Top apron cradle, apron and apron top roller with cot (aprons for top roller Ø 25 mm):				
100	OH 514-0962 745 (OH short)	PR 40-0997 575	LP 1017-0013 010	2
	OH 534-0962 764 (OH medium)	PR 4010-0002 503		
110	OH 514-0962 746 (OH short)	PR 40-0997 575	LP 1017-0013 011	2
	OH 534-0962 765 (OH medium)	PR 4010-0002 503		
	OH 524-0962 755 (OH long)	PR 4011-0002 504		
130	OH 514-0962 747 (OH short)	PR 40-0997 575	LP 1017-0013 012	2
	OH 534-0962 766 (OH medium)	PR 4010-0002 503		

Draft field setting³⁾

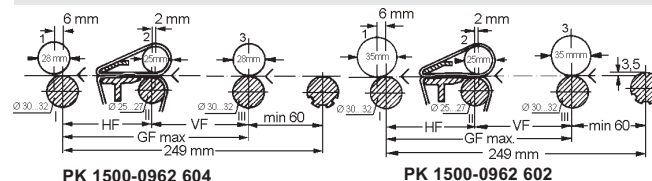

Draft field settings and max.fibre length

Weighting arm PK	Top apron cradle OH	Field distances in mm				Max.fibre length mm
		HF	VF	VF usual ⁴⁾	GF mm	
PK 1500-0962 604	OH 514	49	40	4)	189	45
	OH 534	60	40	4)	189	54
	OH 524	76	40	4)	189	60
PK 1500-0962 602	OH 514	49	40	4)	189	45
	OH 534	60	40	4)	189	54
	OH 524	76	40	4)	189	60

Clips

for OH 514 ↑
for OH 534 ↔ OLC-0964 104 white, OLC-0964 106 black, OLC-0964 108 green
for OH 524 ↓

Bottom roller dia. in mm (mere reference values)	Front	
	I	30/32
	Middle	25/27
	Rear	
	III	30/32

¹⁾ Ref.Nos. mentioned are for top rollers without cots.
Cot quality according to customers' request.

²⁾ Position in weighting arm: 1 = Front 1
(see fig. on next page) 2 = Middle 2
3 = Rear 3

³⁾ The mentioned draft field distances take a front zone condenser into account.
Without front zone condenser the front zone (HF) can be shortened.

⁴⁾ The distance VF_{usual} depends on the fibre to be spun and fibre length.
The values are gathered in practical use.



TEXParts Weighting arms PK 1500 Equipment and draft system data Cotton speed frames

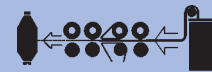

Equipment for weighting arm PK 1500-0001 938

(Equipment is not included in delivery volume of weighting arm)

Gauge TW in mm	Top apron cradle OH	Apron	Top roller ¹⁾ (without cot) Ref.no.	Position in weighting arm ²⁾
Front and rear top roller:				
100			LP 1015-0025 227	1/ 2/ 4
110			LP 1015-0025 228	1/ 2/ 4
130			LP 1015-0025 229	1/ 2/ 4
Top apron cradle, apron and apron top roller with cot (aprons for top roller Ø 25 mm):				
100	OH 514-0962 745 (OH short)	PR 40-0997 575	LP 1017-0013 010	3
110	OH 514-0962 746 (OH short)	PR 40-0997 575	LP 1017-0013 011	3
130	OH 514-0962 747 (OH short)	PR 40-0997 575	LP 1017-0013 012	3

Draft system setting

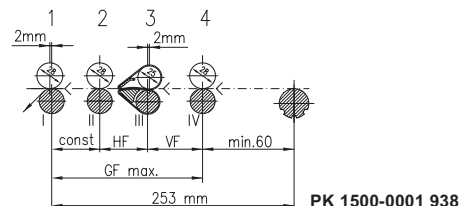

Draft field settings and max. fibre length

Weighting arm PK	Top apron cradle OH	Field distances in mm			GF mm max.	Fibre length mm
		HF	Con-stant ³⁾	VF min usual ⁴⁾		
PK 1500-0001 938	OH 514	49	34	45 ⁴⁾	193	45

Clips

for OH 514
for OH 534
for OH 524

OLC-0964 104 white, OLC-0964 106 black, OLC-0964 108 green

Bottom roller dia. in mm (mere reference values)	Front	I	30/32
	Middle	II	30/32
	Middle	III	30/32
	Rear	IV	30/32

³⁾ The figure mentioned is the shortest possible distance of the bottom rollers depending on the PK-construction. Enlarged distances depend on the condensers and the field distance setting.

⁴⁾ The distance VF_{usual} depends on the fibre to be spun and fibre length. The values are gathered in practical use.

¹⁾ Ref. Nos. mentioned are for top rollers without cots. Cot quality according to customers' request.

In case of 4-roller-type PK 1500-0001 938 top roller combination is 28-28-25-28 mm and top roller types LP1015- LP1015- LP 1017- LP 1015. Normally the OH 514 is used.

²⁾ Position in weighting arm: 1 = Front 1
(see fig. on next page) 2 = Middle 2
3 = Middle 3
4 = Rear 4



TEXParts Weighting arm PK 6000



Application

Ring frame 3-roller double apron draft system PK 6000.

With top apron cradle OH 6022 for all kinds of wool and synthetic fibres up to 200 mm. Blends of these.

Preparation: Classical worsted yarn assortment with finishing machine or worsted speed frame.

See also chapter 9 page 66.

Ring frames
Speed frames

Worsted mills

Chapter 5-26

Types
Ref.no.

PK 6000-1252 924¹⁾

Operating
pressure

from 1,5 bar

up to 4,0 bar

Load on top roller (daN)
Front 1 Middle 2 Rear 3

from 1,5 bar	17	7,5	14
up to 4,0 bar	36	16,8	33
Top roller for PK 6000 Ø mm²⁾	50	33	50

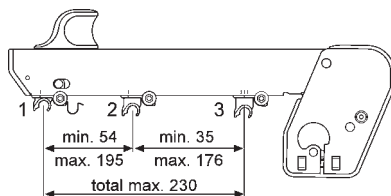

PK 6000 - 1252 924

Measurements are given in mm.

¹⁾ Pneumatic loading; air pressure required.
²⁾ Dia. values refer to newly covered top rollers.

Mono clearer
roller holder
Ref.no.

PKHA-1252 848³⁾

Mono clearer roller
Ref. no.

PKPW-1253 433

Remarks

2 pcs. front clearer roller holders are necessary for fixing the mono clearer rollers

for gauges 75mm and 82,5mm
2 pcs. clearer rollers are needed for each weighting arm

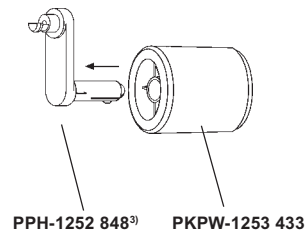

Distances for top roller holders are shown in mm.

³⁾ Clearer roller holder PKHA-1252 848 will be supplied on request as separate item.

Chapter 5-27



TEXParts Weighting arm PK 6000 Equipment and draft system data Worsted ring frames



Equipment for weighting arm PK 6000-1252 924

(Equipment is not included in delivery volume of weighting arm)

Gauge TW in mm	Top apron cradle OH	Apron	Top roller ¹⁾ (without cot) Ref.no.	Position in weighting arm ²⁾
Front and rear top roller:				
75			LP 1014-1253 740	1/ 3
82,5			LP 1014-1253 741	1/3
Top apron cradle, apron and apron top roller with cot (aprons for top roller Ø 33 mm):				
75	OH 6022-1254 311	PR -1253 678	LP 1014-1253 740	2
82,5	OH 6022-1254 312	PR -0022 858	LP 1015-1253 744	2

Draft system setting

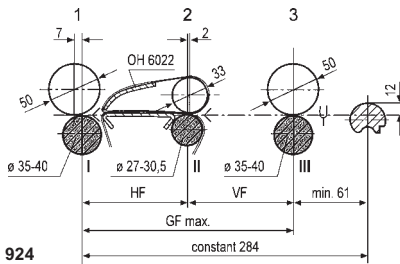

PK 6000-1252 924

Measurements are given in mm.

Clips

For normal bottom apron nose bar: OLC-0964 120 black,
OLC-0004 587 beige, OLC-0004 588 green

Weighting arms, draft field distances and max. fibre length

Weighting arm	Top apron cradle	Bottom roller diameter			Draft field mm			Total draft field GF mm max	Fibre length max. mm
		I	II	III	HF	VF	VF _{used}		
PK 6000-1252 924	OH 6022	35/40	27/30,5	35/40	105	57 ³⁾	⁴⁾	223	200

¹⁾ Ref.Nos.mentioned are for top rollers without cots.
Cot quality according to customers' request.

²⁾ Position in weighting arm: 1 = Front
(see fig. on next page) 2 = Middle
3 = Rear

³⁾ Without rear zone condenser the rear zone setting reduces to 45 mm at min.

⁴⁾ Depends on fibre length and roving material.



TEXParts Weighting arms PK 1601



Application

Ring frame 3-roller
double apron draft system
PK 1601-0962 670.

Apron top roller as
recessed roller.

With top apron cradle
OH 2402 or OH 554:
all kinds of wool and
synthetic fibres up to
200 mm. Blends of
these.

Preparation:
Classical worsted yarn
assortment with finishing
machine or worsted
speed frame.

See also chapter 9
page 75.

Ring frames
Speed frames

Worsted mills

Chapter 5-30

Types Ref.no.

PK1601-0962 670

Loads in daN

Front 1	20	27	35	50
Middle 2	9	12	15	48
Rear 3	20	25	30	50

For top roller Ø mm¹⁾

Clearer roller holder²⁾

Front of arm
Ref.no.

PFE-0996 685

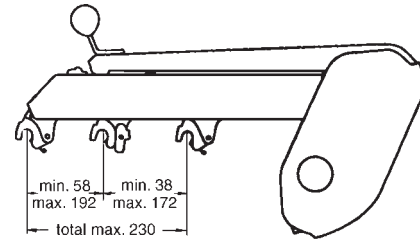

PK 1601-0962 670

Measurements are given in mm.

²⁾ Clearer roller holders will be supplied on request as separate items.
Condensers are shown on chapter 5 pages 66-73.
Distances for top roller holders are shown in mm.

¹⁾Dia. values refer to newly covered top rollers.



TEXParts Weighting arms PK 1601 Equipment and draft system data Worsted ring frames



Equipment for weighting arm PK 1601-0962 670

(Equipment is not included in delivery volume of weighting arm)

Gauge TW in mm	Top apron cradle OH	Apron	Top roller ¹⁾ (without cot) Ref.no.	Position in weighting arm ²⁾
Front and rear top roller:				
75			LP 1014-1253 740	1/ 3
82,5			LP 1014-1253 741	1/ 3
90			LP 1014-1253 742	1/ 3
Top apron cradle, apron and apron top roller with cot (aprons for top roller Ø 48 mm):				
75	OH 2402-1253 436 (short)	PR 3217-1252 275	LP 1016-1256 711	2
	OH 554-0962 767 (medium)	PR 325-0998 141		
82,5	OH 2402-1253 437 (short)	PR 4017-1252 276	LP 1017-1256 712	2
	OH 554-0962 768 (medium)	PR 405-0997 462		
90	OH 554-0962 769 (medium)	PR 405-0997 462	LP 1017-1256 713	2

¹⁾ Ref.Nos. mentioned are for top rollers without cots.
Cot quality according to customers' request.

²⁾ Position in weighting arm: 1 = Front
(see fig. on next page) 2 = Middle
3 = Rear

Draft system setting

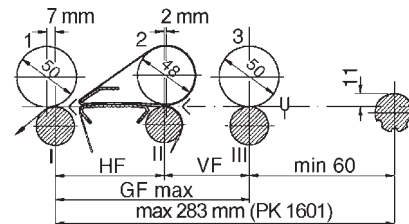

PK 1601-0962 670

Clips

For normal bottom apron nose bar: OLC-0964 120 black,
OLC-0004 587 beige, OLC-0004 588 green.

Weighting arms, draft field distances and max. fibre length

Weighting arm PK	Top apron cradle OH	Field distances in mm			GFmax. mm	Max. fibre length mm Slip draft
		HF	VF min.	VF usual ³⁾		
with bottom apron nose bar:						
PK 1601-0962 670	OH 2402	105	57	³⁾	223	200

³⁾ Depends on fibre length and roving material.



TEXParts Top apron cradles OH 2022



Application

Cotton ring frame
draft systems with
TEXParts weighting arms
PK 3025, PK 3035
PK 2025, PK 2035,
PK 2055 and PK 2065.

Cradle Types Ref.no.	Dimensions in mm				Top aprons ¹⁾		Basic equipment Distance clips ²⁾ Ref.no.	Colour
	Tw	L	b	d	R	E		
OH 2022-1247 888	68,4	99,8	28,4	28,4	35	51,4	 OLC-0964 118 OLC-0017 705 OLC-0964 119	yellow
OH 2022-1247 887	75	106,4	28,4	28,4	35	51,4		lilac
OH 2022-1247 889	82,5	113,9	28,4	28,4	35	51,4		white

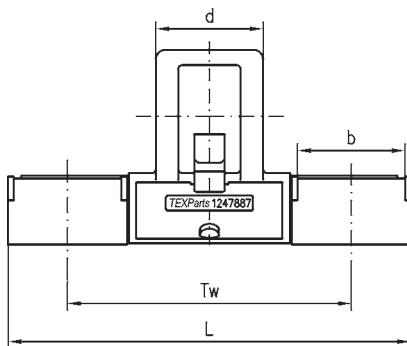

OH 2022

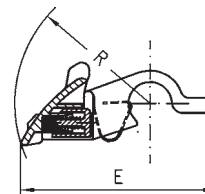

OH 2022

Ring frames

Cotton mills

- ¹⁾ Top apron for apron top roller with 25 mm diameter.
Top aprons must be ordered as separate items.
- ²⁾ Set of distance clips for OH 2022. Clips are not included in standard OH supply and have to be ordered separately.



TEXParts Top apron cradles OH 62



Application

Cotton ring frame draft systems with TEXParts weighting arms PK 2025, PK 2035, PK 2055 and PK 2065.

Also designated as short OH.

Cradle Types Ref.no.	Dimensions in mm				R	E	Top aprons ²⁾ PR 32	Basic equipment Distance clips ³⁾ Ref.no.	Colour
	Tw ¹⁾	L	b	d					
OH 62-0962 841	90	125	32,4	50	35	53	PR 32	↑ OLC-0964 118 OLC-0017 705 ↓ OLC-0964 119	yellow lilac white

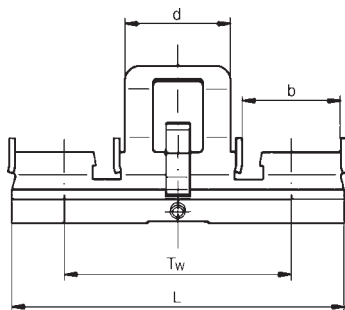

OH 62

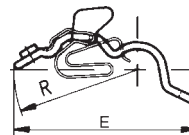

OH 62

Ring frames

Cotton mills

¹⁾ OH 62 cradles with gauges 68,4mm, 75mm and 82,5mm have been replaced by OH 2022 top apron cradles.

²⁾ Top apron for apron top roller with 25 mm diameter. Top aprons must be ordered as separate items.

³⁾ Set of distance clips for OH 62. Clips are **not** included in standard OH supply and have to be ordered separately.



TEXParts Top apron cradles OH 2042



Application

Cotton ring frame draft systems with TEXParts weighting arms PK 3025, PK 3035, PK 2025, PK 2035, PK 2055, PK 2065.

Also designated as medium OH.

Cradle Types Ref.no.	Dimensions in mm				Top aprons ¹⁾		Basic equipment Distance clips ²⁾ Ref.no.	Colour
	Tw	L	b	d	R	E		
OH 2042-1250 133	68,4	99,8	28,4	28,4	42,5	58,9	↑ OLC-0964 117 OLC-0964 118 ↓ OLC-0964 119	red yellow white
OH 2042-1250 134	75	106,4	28,4	28,4	42,5	58,9		

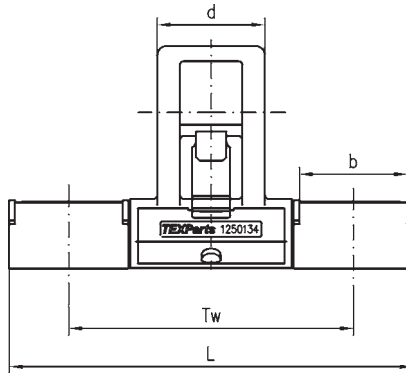

OH 2042

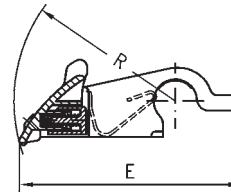

OH 2042

Ring frames

Cotton mills

- ¹⁾ Top apron for apron top roller with 25 mm diameter. Top aprons must be ordered as separate items.
- ²⁾ Set of distance clips for OH 2042. Distance clips are **not** included in standard OH supply and have to be ordered separately.



TEXParts Top apron cradles OH 132



Application

Cotton ring frame
draft systems with
TEXParts weighting arms
PK 2025, PK 2035,
PK 2055 and PK 2065.

Also designated
as medium OH.

Cradle Types Ref.no.	Dimensions in mm				R	E	Top aprons ²⁾ Ref.no.	Basic equipment Distance clips ³⁾ Ref.no.	Colour
	Tw	L	b	d					
OH 132-0963 700 ¹⁾	68,4	103	28,4	30	42,5	52,5	PR 283	↕ OLC-0964 117 OLC-0964 118 OLC-0964 119	red yellow white
OH 132-0963 660 ¹⁾	75	114	32,4	35	42,5	52,5	PR 323		
OH 132-0963 671	82,5	122	32,4	35	42,5	52,5	PR 323		

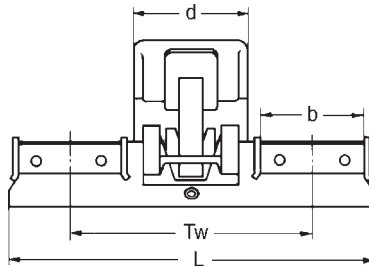

OH 132

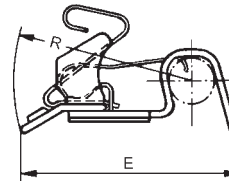

OH 132

Ring frames

Cotton mills

¹⁾Delivery until using-up of stock.

²⁾ Top apron for apron top roller with 25 mm diameter.
Top aprons must be ordered as separate items.

³⁾ Set of distance clips for OH 132. Clips are **not** included in standard OH supply and have to be ordered separately.



TEXParts Top apron cradles OH 1225



Application

Cotton ring frame
draft systems with
TEXParts weighting arms
PK 3025, PK 3035

Cradle Types Ref.no.	Dimensions in mm				Top aprons ¹⁾			Basic equipment Distance clips ²⁾ Ref.no.	Colour
	Tw	L	b	d	R	E			
OH 1225-6001 674*	68,4	103	28,4	29,2	58,3	67,7	PR 028	OLC-0964 118 OLC-0964 119 OLC-0017 627	yellow white grey
OH 1225-6001 257*	75	114	28,4	29,2	58,3	67,7	PR 032		
OH 1225-6001 675*	82,5	122	28,4	29,2	58,3	67,7	PR 032		

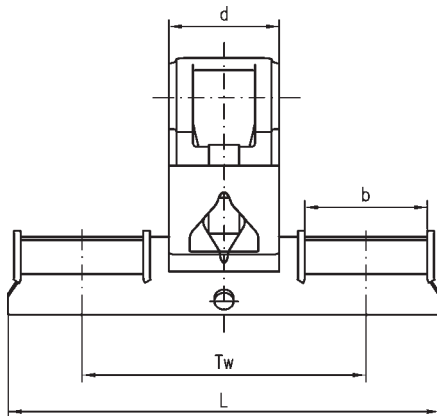

OH 1225

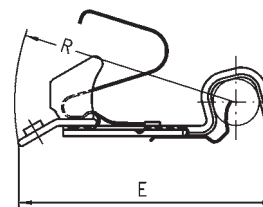

OH 1225

Ring frames

Cotton mills

Chapter 5-42

* Available on request!

- ¹⁾ Top apron for apron top roller with 25 mm diameter.
Top aprons must be ordered as separate items.
- ²⁾ Set of distance clips for OH 1225. Clips are **not** included in standard OH supply and have to be ordered separately.



TEXParts Top apron cradles OH 122



Application

Cotton ring frame
draft systems with
TEXParts weighting arms
PK 2025, PK 2035,
PK 2055 and PK 2065.

Also designated
as long OH 60.

Cradle Types Ref.no.	Dimensions in mm				Top aprons ¹⁾		Basic equipment Distance clips ²⁾ Ref.no.	Colour
	Tw	L	b	d	R	E		
OH 122-0963 495	68,4	103	28,4	35	58,3	69	↑ OLC-0964 118 OLC-0964 119 ↓ OLC-0017 627	yellow white grey
OH 122-0963 500	75	114	32,4	35	58,3	69		
OH 122-0963 511	82,5	122	32,4	35	58,3	69		

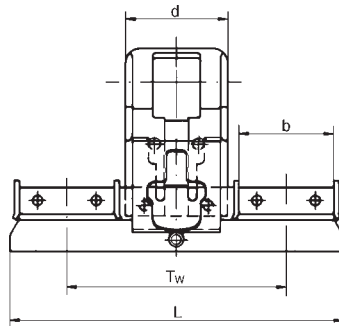

OH 122

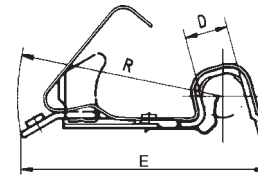

OH 122

Ring frames

Cotton mills

- ¹⁾ Top apron for apron top roller with 25 mm diameter.
Top aprons must be ordered as separate items.
- ²⁾ Set of distance clips for OH 122. Clips are **not** included
in standard OH supply and have to be ordered separately.



TEXParts Top apron cradles OH 5022



Application

Cotton speed frame
draft systems with
TEXParts weighting arms
PK 5000

Also designated
as short OH.

Cradle Types Ref.no.	Dimensions in mm				Top aprons ¹⁾			Basic equipment Distance clips ²⁾ Ref.no.	Colour	
	Tw	L	b	c	d	R	E			
OH 5022-6004 092	100	143,4	40,4	18,8	48	35	49,6	PR 40	↑ OLC-0964 104 ↓ OLC-0964 106 OLC-0964 108	white black green
OH 5022-1259 297	110	153,4	40,4	18,8	48	35	49,6	PR 40		

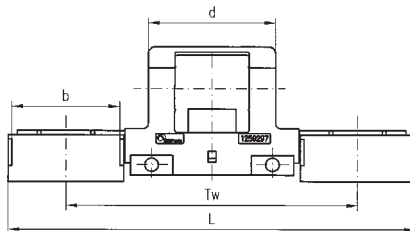

OH 5022

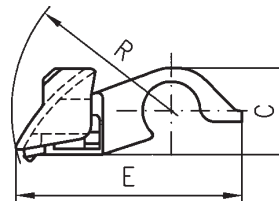

OH 5022

Speed frames

Cotton mills

Chapter 5-46

- ¹⁾ Top apron for apron top roller with 25 mm diameter.
Top aprons must be ordered as separate items.
- ²⁾ Set of distance clips for OH 5022. Clips are **not**
included in standard OH supply and have to be ordered separately.



TEXParts Top apron cradles OH 514



Application

Cotton speed frame draft systems with TEXParts weighting arms PK 1500, PK 1600

Also designated as short OH.

Cradle Types Ref.no.	Dimensions in mm				d	R	E	Top aprons ¹⁾ PR 40	Basic equipment Distance clips ²⁾ Ref.no.	Colour
	Tw	L	b	c						
OH 514-0962 744	82,5	145,5	40,4	18,5	28,6	34,5	47	PR 40 PR 40 PR 40 PR 40	↕ OLC-0964 104 OLC-0964 106 OLC-0964 108	white black green
OH 514-0962 745	100	163,0	40,4	18,5	28,6	34,5	47			
OH 514-0962 746	110	173,0	40,4	18,5	28,6	34,5	47			
OH 514-0962 747	130	193,0	40,4	18,5	28,6	34,5	47			

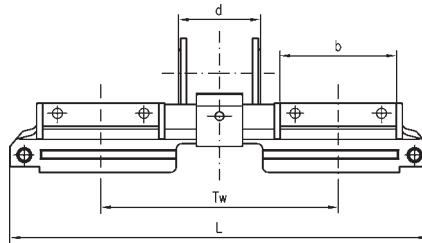

OH 514

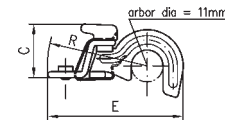

OH 514

Speed frames

Cotton mills

¹⁾ Top apron for apron top roller with 25 mm diameter. Top aprons must be ordered as separate items.

²⁾ Set of distance clips for OH 514. Clips are **not** included in standard OH supply and have to be ordered separately.



TEXParts Top apron cradles OH 5042



Application

Cotton speed frame draft systems with TEXParts weighting arms PK 5000.

Also designated as medium OH.

Cradle Types Ref.no.	Dimensions in mm				d	R	E	Top aprons ¹⁾	Basic equipment Distance clips ²⁾ Ref.no.	Colour
	Tw	L	b	c						
OH 5042-1259 506	110	153,4	40,4	19	48	45	59,6	PR 4010	↑ OLC-0964 104 OLC-0964 106 ↓ OLC-0964 108	white black green

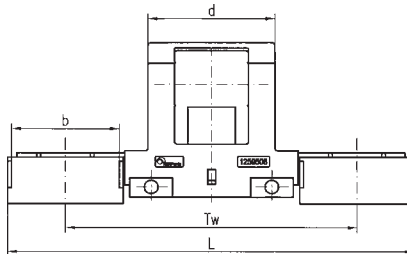

OH 5042

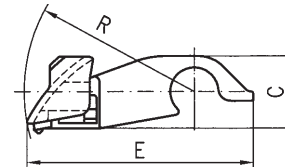

OH 5042

Speed frames

Cotton mills

¹⁾ Top apron for apron top roller with 25 mm diameter.
Top aprons must be ordered as separate items.

²⁾ Set of distance clips for OH 5042. Clips are **not** included in standard OH supply and have to be ordered separately.



TEXParts Top apron cradles OH 534



Application

Cotton speed frame draft systems with TEXParts weighting arms PK 1500, PK 1600.

Also designated as medium OH.

Cradle Types Ref.no.	Dimensions in mm				d	R	E	Top aprons ¹⁾	Basic equipment Distance clips ²⁾ Ref.no.	Colour
	Tw	L	b	c						
OH 534-0962 764	100	163,0	40,4	17,8	28,6	45	57,5	PR 4010	OLC-0964 104 OLC-0964 106 OLC-0964 108	white
OH 534-0962 765	110	173,0	40,4	17,8	28,6	45	57,5	PR 4010		black
OH 534-0962 766	130	193,0	40,4	17,8	28,6	45	57,5	PR 4010		green

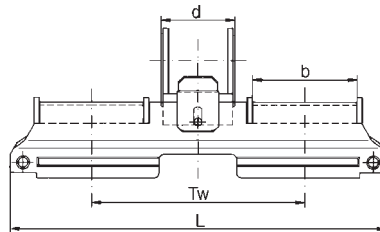

OH 534

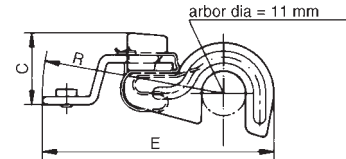

OH 534

Speed frames

Cotton mills

- 1) Top apron for apron top roller with 25 mm diameter
For apron top roller with 33 mm diameter PR 407 is applicable.
Top aprons must be ordered as separate items.
- 2) Set of distance clips for OH 534. Clips are **not** included in standard OH supply and have to be ordered separately.



TEXParts Top apron cradles OH 5245



Application

Cotton speed frame draft systems with TEXParts weighting arms PK 5000.

Also designated as long OH.

Cradle Types Ref.no.	Dimensions in mm				d	R	E	Top aprons ¹⁾ PR 4011	Basic equipment Distance clips ²⁾ Ref.no.	Colour
	Tw	L	b	c						
OH 5245-1260 370	110	173,0	40,4	16	35,6	60,5	76	PR 4011	OLC-0964 104 OLC-0964 106 OLC-0964 108	white black green

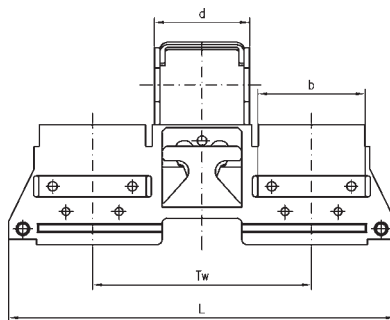

OH 5245

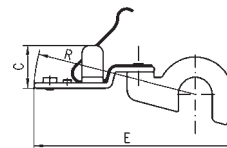

OH 5245

Speed frames

Cotton mills

Chapter 5-54

¹⁾ Top apron for apron top roller with 25 mm diameter.
Top aprons must be ordered as separate items.

²⁾ Set of distance clips for OH 5245. Clips are **not** included in standard OH supply and have to be ordered separately.



TEXParts Top apron cradles OH 524



Application

Cotton speed frame draft systems with TEXParts weighting arms PK 1500, PK 1600.

Also designated as long OH.

Cradle Types Ref.no.	Dimensions in mm				d	R	E	Top aprons ¹⁾ PR 4011 PR 4011	Basic equipment Distance clips ²⁾ Ref.no.	Colour
	Tw	L	b	c						
OH 524 -0962 753	82,5	145,5	40,4	16	28,6	60,5	73	↕	OLC- 0964 104	white
OH 524 -0962 755	110	173,0	40,4	16	28,6	60,5	73		OLC- 0964 106	black
									OLC- 0964 108	green

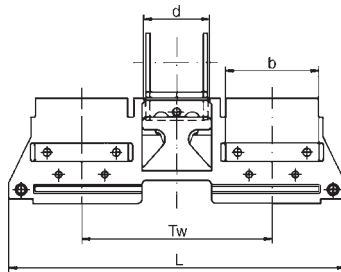

OH 524

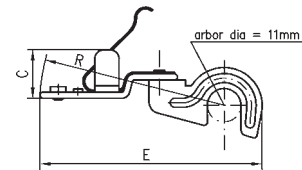

OH 524

Speed frames

Cotton mills

- 1) Top apron for apron top roller with 25 mm diameter. For apron top roller with 33 mm diameter PR 408 is applicable. Top aprons must be ordered as separate items.
- 2) Set of distance clips for OH 524. Clips are **not** included in standard OH supply and have to be ordered separately.



TEXParts Top apron cradles OH 2402



Application

Worsted ring frame draft systems with TEXParts weighting arms PK 1601.

Cradle Types Ref.no.	Dimensions in mm			Apron top roller diameter	Top aprons	Basic equipment Distance clips ¹⁾ Ref.no.	Colour
	Tw	L	b				
OH 2402-1253 436	75	110,5	32,5	48	PR 3217	OLC-0964 120 OLC-0004 587 OLC-0004 588	black beige green
OH 2402-1253 437	82,5	126,5	40,5	48	PR 4017		

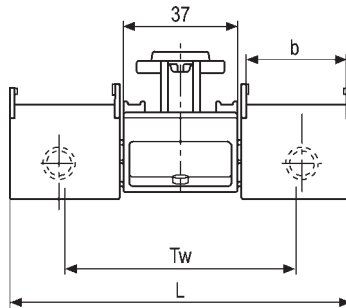

OH 2402

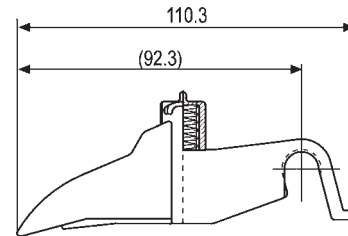

OH 2402

Ring frames

Worsted mills

¹⁾ Set of distance clips for OH 2402. Clips are **not** included in standard OH supply and have to be ordered separately.



TEXParts Top apron cradles OH 554



Application

Worsted ring frame
draft systems with
TEXParts weighting arms
PK 1601.

Cradle Types Ref.no.	Dimensions in mm				Top aprons ¹⁾		Basic equipment Distance clips ²⁾ Ref.no.	Colour
	Tw	L	b	d	R	E		
OH 554-0962 767	75	111	32,4	28,6	89,5	101	↑ OLC-0964 120 OLC-0004 587 ↓ OLC-0004 588	black beige green
OH 554-0962 768	82,5	126,5	40,4	28,6	89,5	101		
OH 554-0962 769	90	134	40,4	28,6	89,5	101		

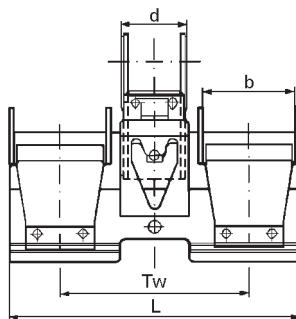

OH 554

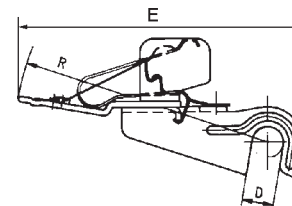

OH 554

Ring frames

Worsted mills

- ¹⁾ Top apron for apron top roller with 48 mm diameter.
Top aprons must be ordered as separate items.
- ²⁾ Set of distance clips for OH 554. Clips are **not** included in standard OH supply and have to be ordered separately.

TEXParts

Top apron cradles OH 6022

Application

Worsted ring frame draft systems with TEXParts weighting arms PK 6000.

Cradle Types Ref.no.	Dimensions in mm				R	E	Top aprons ¹⁾ PR-1253 678 PR-0022 858	Basic equipment Distance clips ²⁾ Ref.no. OLC-0964 120 OLC-0004 587 OLC-0004 588	Colour
	Tw	L	b	d					
OH 6022-1254 311	75	110,5	32,4	37	88,8	98			black
OH 6022-1254 312	82,5	126	40,4	37	88,8	98			beige green

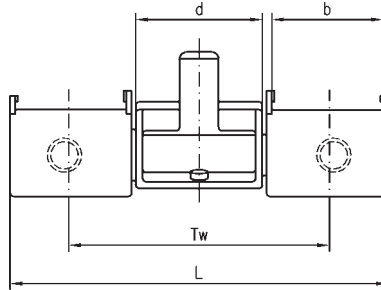

OH 6022

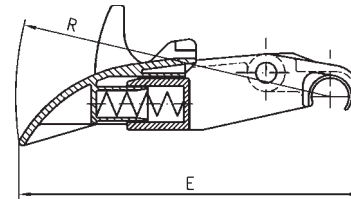

OH 6022

Ring frames

Worsted mills

- ¹⁾ Top apron for apron top roller with 33 mm diameter. Top aprons must be ordered as separate items.
- ²⁾ Set of distance clips for OH 6022. Clips are **not** included in standard OH supply and have to be ordered separately.



TEXParts
Bottom apron nose bar

TEXParts
Bottom apron nose bar



Application

Cotton ring frame draft systems with TEXParts weighting arms PK 3025, PK 3035, PK 2025, PK 2035, PK 2055 and PK 2065.

Cotton speed frame draft systems with TEXParts weighting arms PK 5000, PK 1500.

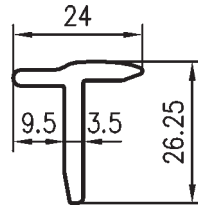

Profile P1¹⁾
short version

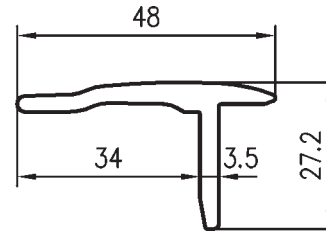

Profile P3¹⁾
long version

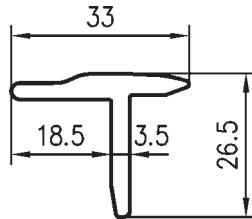

Profile P2¹⁾
medium version

Ring frames
Speed frames

Cotton mills

Ring frames
Speed frames

Cotton mills

¹⁾ Completely machined: dimensions and surface finish as specified by customer.

¹⁾ Completely machined: dimensions and surface finish as specified by customer.



TEXParts Roving guides, condensers

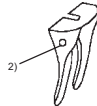

Application	Types Ref.no. ¹⁾	Roving guides/Condensers	Used in draft systems	Symbol	Remarks
Ring frame 3 roller double apron draft systems.	KL-0011 034	Rear roving guide	Cotton ring frames for PK 2055, PK 2065		suited for profile 12 x 4 mm
Speed frame 3 roller double apron draft systems. Speed frame 4 roller draft systems.	KL-0998 282* KL-0998 283* KL-0998 284* KL-0998 285*	Front zone condenser	Speed frames PK 400, PK 500, PK 600, PK 700, PK 800, PK 1500, PK 1600, PK 5000		6 - yellow, delivery apert. 9 - uncoloured 12 - black 16 - green

Ring frames
Speed frames

Cotton mills

¹⁾ Products marked with * at Ref.no. are stamped with TEXParts characters for designation.

²⁾ Colour mark indicates size.



TEXParts Roving guides, condensers



Application

Ring frames 3 roller
double apron draft
systems

Types
Ref.no.¹⁾

Gauge
mm

**Roving guides/
Condensers**

KL-1246 243* 68,4-75
KL-1246 070* 82,5
KL-1246 244* 90-100

↑ Front zone condenser;
swinging legs are
spring-suspended
↓

KL-1248 233* 68,4-75
KL-1248 234* 82,5
KL-1248 235* 90-100

↑ Front zone condenser;
swinging legs are held
by slotted cheese head
screws
↓

PFE-0997 405²⁾

Spring

**Used in draft
systems**

Worsted ring frame
PK 600, PK 1601, PK 1700
and PK 6000 series

Worsted ring frame
PK 600, PK 1601, PK 1700
and PK 6000 series

**Swinging leg
Ref.no.**

↑ 1246 071
(swinging leg right hand)
1246 072
(swinging leg left hand)
↓

↑ 1246 071
(swinging leg right hand)
1246 072
(swinging leg left hand)
↓

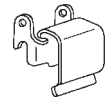

PFE-0997 405²⁾

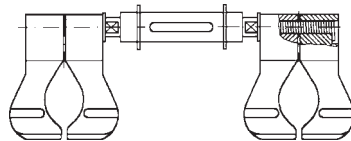

KL -1246 243
KL -1246 070
KL -1246 244

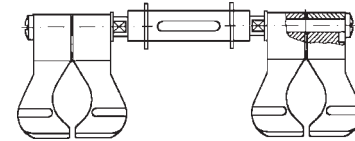

KL- 1248 233
KL -1248 234
KL -1248 235

Ring frames

Worsted mills

Chapter 5-68

¹⁾ Products marked with * at Ref.no. are stamped
with TEXParts characters for designation.

²⁾ Retaining spring for all front zone condensers for PK 1600, PK 1700 series.

Chapter 5-69



TEXParts Roving guides, condensers



Application	Types Ref.no.	Roving guides/Condensers	Used in draft systems	Symbol	Remarks
Ring frames with 3 and more roller draft systems. Speed frames with 3 and more roller draft systems.	KL-0997 469	Rear zone condenser	↕ Worsted ring frames PK 1601 and PK 6000 series		.

Ring frames

Worsted mills

Chapter 5-70

Chapter 5-71



TEXParts
Distance clips OLC

TEXParts
Distance clips OLC



Application

For top apron cradles in draft systems with weighting arms
PK 3025, Pk 3035
PK 2025, PK 2035,
PK 2055, PK 2065,
PK 700, PK 800,
PK 1700, PK 1600,
PK 6000.

For center-supported.

Ring frames
Speed frames

Cotton mills
Semi-worsted mills
Worsted mills

Types
Ref.no.

Symbol

Colour

OLC-0964 117



red

OLC-0964 118



yellow

OLC-0017 705



lilac

OLC-0964 119



white

OLC-0017 627



grey

OLC-0964 120



black

OLC-0004 587



beige

OLC-0004 588



green

OLC-0004 589



pink

OLC-0964 123



blue

OLC-0964 124



brown

Types
Ref.no.

Symbol

Colour

OLC-0964 102



red

OLC-0964 103



yellow

OLC-0964 104



white

OLC-0964 105



grey

OLC-0964 106



black

OLC-0030 491



orange

OLC-0964 107



beige

OLC-0964 108



green

OLC-0964 109



blue

OLC-0964 110



brown

OLC-0007 685
OLC-0007 686
OLC-0007 687
OLC-0007 688



black
beige
green
pink

Application

For top apron cradles in draft systems with weighting arms PK 1500, PK 5000 and PK 1600 series.
OLC-0030 491 and OLC-0964 102 to OLC-0964 110 are for lateral support.

OLC-0007 685 to OLC-0007 688, used in short bottom apron systems with UH 54, for worsted draft systems with weighting arms type PK 1601 are for mid-support.

Ring frames
Speed frames

Cotton mills
Worsted mills



TEXParts Setting tools

TEXParts Setting tools



Application

For draft systems with weighting arms PK 3025 and PK 3035.

See also chapter 5 pages 2-5.

* **Setting tools** can be supplied individually or as a complete set in a tool bag (1259 672).

Optional accessories:
These adjustment tools are supplied on special request.

Ring frames

Cotton mills

Chapter 5-74

Setting* tools

Types Ref.no.

Symbol

Tool set
with bag

1259 672

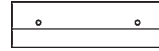

Draft field gauge

6001 102

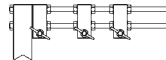

Screwdriver SW 6

1255 195



Ratchet 1/4"
(handle reversible)

0997 453



Pliers for cover

1255 145

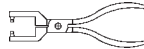

Allen key (key 4)

0993 570



Allen key (key 3)

1255 216



Spanner

1255 215



Ball-screwdriver

1259 713



Height setting
gauge

1260 156

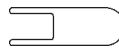

Height control
gauge

6001 918



Optional accessories:

Torquey key with
inserts (1-12 Nm)

1259 653



Tube cutter

6001 490



Setting* tools

Types Ref.no.

Symbol

Tool set
with bag

1251 683

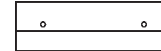

Draft field
gauge¹⁾

0997 440

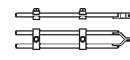

Distance
gauge¹⁾

0011 687



Height
gauge¹⁾

0994 122



Setting
wrench¹⁾

0998 222

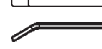

Screwdriver
(5 with handle)

0997 491



Allen key (key 4)

1249 383



Optional accessories:

Ratchet
1/4"

0997 453



Screwdriver bit
SW 6
SW 5

0997 454

0997 455



Slide calipers
with prism
jaws

0026 840



Application

For draft systems with weighting arms PK 2025, PK 2035, PK 2055 and PK 2065.

See also chapter 5 pages 5-13.

* **Setting tools** can be supplied individually or as a complete set in a tool bag (1251 683).

Optional accessories:
These adjustment tools are supplied on special request.

Ring frames

Cotton mills

Chapter 5-75



TEXParts Setting tools

Application

For draft systems with weighting arms
PK 1500, PK 1601.

See also chapter 5
pages 20-25 and 30-33.

* **Setting tools** can be supplied individually or as a complete set in a tool bag (0994 131).

Ring frames
Speed frames

Cotton mills
Worsted mills

Chapter 5-76

TEXParts Setting tools



Setting* tools

Types Ref.no.

Symbol

Optional accessories:

Screw-
driver-bit⁽²⁾
SW 5

0997 455



Screwdriver
size 6⁽²⁾

0997 445



Slide calipers
with prism
jaws⁽²⁾

0026 840

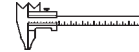

Application

For draft systems with weighting arms
PK 1500 and PK 1601,

* **Optional accessories:**
These adjustment tools are supplied on special request.

Ring frames
Speed frames

Cotton mills
Worsted mills

Chapter 5-77



TEXParts Setting tools

Application







For draft systems with weighting arms PK 6000.

See also chapter 5 pages 26-29.

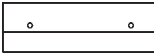
* **Setting tools** can be supplied individually or as a complete set in a tool bag (1253 714).

Ring frames

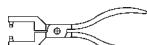
Worsted mills

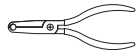
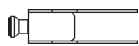
Setting* tools	Types Ref.no.	Symbol
Tool set with bag	1253 714	
Draft field gauge	1254 214	
Screwdriver SW 6	1255 195	
Ratchet 1/4" (handle reversible)	0997 453	
Pliers for cover	1255 145	
Spanner (size 8)	1255 215	
Allen key (key 5) Allen key (key 4) Allen key (key 3)	0993 551 0993 570 1255 216	
Pliers for fitting of the connecting tube	1256 207	
Height control gauge	6002 024	

TEXParts Setting tools

Setting* tools

Tool set with bag

Draft field gauge

Screwdriver SW 6

Ratchet 1/4" (handle reversible)

Pliers for cover

Spanner (size 8)

Allen key (key 4)
Allen key (key 5)

Pliers for fitting of the connecting tube

Height setting gauge

Height control gauge

Optional accessories:

Tube cutter

Torque key with insert (1-12 Nm)

Types Ref.no.

1259 479

6000 639

1255 195

0997 453

1255 145

1255 215

0993 570
0993 551

1256 207

1260 216

6002 024

6001 490

1259 653

Symbol

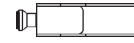
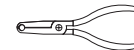
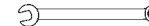
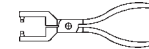
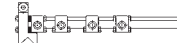
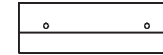

Application

For draft systems with weighting arms PK 5000.

See also chapter 5 pages 14-19.

* **Setting tools** can be supplied individually or as a complete set in a tool bag (1259 479).

Optional accessories:
These adjustment tools are supplied on special request.

Speed frames

Cotton mills



TEXParts
Pneumatic accessories for PK 3000

TEXParts
Pneumatic accessories for
PK 5000 and PK 6000



Application

For draft systems with
weighting arms PK 3025
and PK 3035.

**Special *
accessories**

**Types
Ref.no.**

Symbol

Connecting
piece

1258 491

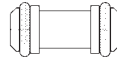

T-screwing

1259 647



L-quick-connector

1257 477



Pneumatic unit

1261 442¹⁾

Pneumatic unit

1261 445¹⁾²⁾

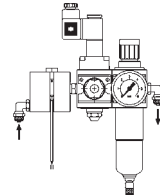

**Special *
accessories**

**Types
Ref.no.**

Symbol

End piece

1259 498



T-screwing

1259 647



L-quick-connector

1257 477



Pneumatic unit

1261 389¹⁾

Pneumatic unit

1261 444¹⁾²⁾

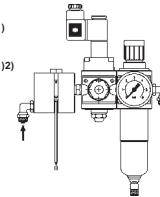

Application

For draft systems with
weighting arms PK 5000
and PK 6000.

Ring frames

Cotton mills

¹⁾ with air filter and automatic condensate separator
²⁾ with pressure monitor

¹⁾ with air filter and automatic condensate separator
²⁾ with pressure monitor

Rotor spindles, beater spindles, bearing units	1
Rotor spindles TL	2
Elastic bush EB	2
Rotor spindles TL	4
Beater spindle LE	6
Beater spindle LE	8
Bearing units IL	10
Bearing units SR and ZB	12
Bearing units ZL	13



TEXParts Rotor spindles TL Elastic bush EB



Application

Rotor spindles for
rotor spinning frames
Rieter M 1/1 and M 2/1.

Rotor spindle Ref.no.	Speed n max. min ⁻¹
TL 226-1245 856 ¹⁾	80 000
TE 226-1246 784	80 000

Elastic bush	EB 226-0030 746
--------------	-----------------

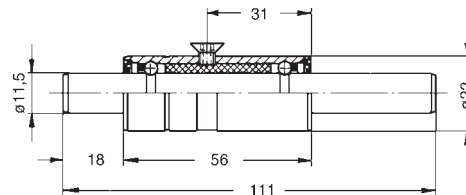

TL 226-1245 856

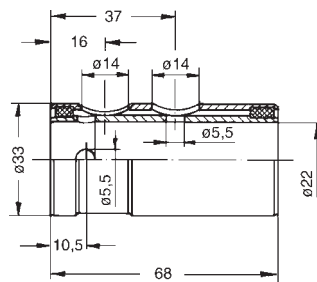

EB 226-0030 746

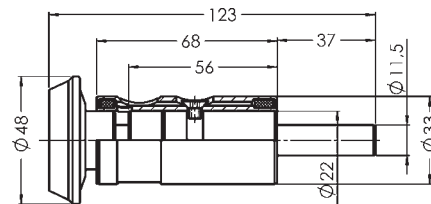

TE 226-1246 784

Rotor spinning frames

Cotton mills

Chapter 6-2

¹⁾ spindle oil-lubricated



TEXParts Rotor spindles TL

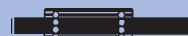

Application

For rotor spinning frames
Platt Saco Lowell types
883, 885 and 887.

**Rotor spindle
Ref.no.**

TL 240-0018 814³⁾

**Spindle
version
Ref.no.**

B¹⁾²⁾

**Speed
n max
min⁻¹**

75 000

**Weight
kg**

0,230

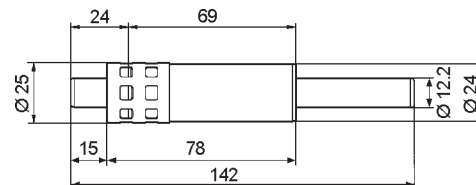

TL 240-0018 814

Rotor spinning frames

- ¹⁾ Spindle version B: oil-lubricated
- ²⁾ Only for machine type 883 and 887 „side feed conversion“.
- ³⁾ Replacement for TL 240-0004 613

Cotton mills

Chapter 6-4

Chapter 6-5



TEXParts Beater spindle LE

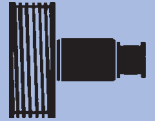

Application

Beater spindle LE 222
for rotor spinning frames
RU 11 and RU 14 of
Messrs. Rieter Ingolstadt

Beater spindle
Ref.no.

LE 222-0016 427

Beater spindle with wharve
Ref.no.

LE 222-0022 647

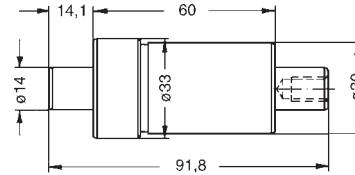

LE 222-0016 427

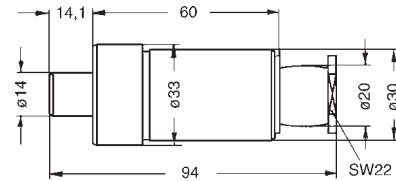

LE 222-0022 647

Rotor spinning frames

Cotton mills

Chapter 6-6

Chapter 6-7

TEXParts

Beater spindle LE

Application

Beater spindle for rotor spinning frames of Messrs. Schlafhorst.

Beater spindle with wharve
Ref.No.

suitable for spin box type

LE 222-0027 128	SE 8
LE 222-0035 965	SE 8
LE 222-1252 507	SE 9
LE 222-1257 825	SE 10/11

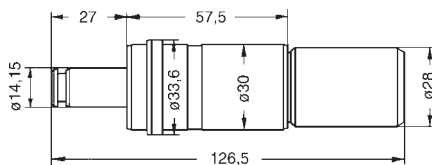

LE 222-0027 128

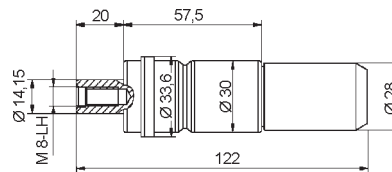

LE 222-1252 507

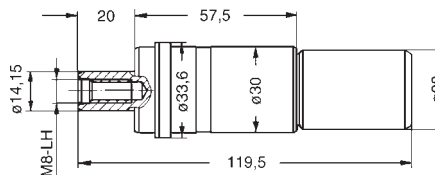

LE 222-0035 965

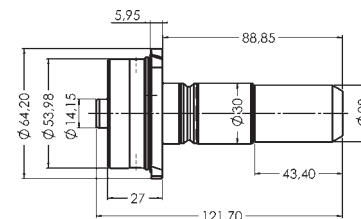

LE 222-1257 825

Rotor spinning frames

Cotton mills

Chapter 6-8

Chapter 6-9

TEXParts

Bearing units IL



Application

Bearing units for support rolls in rotor spinning frames

Types Ref.no.	Dimensions in mm					Speed n max min ⁻¹	Load fig. in N per row		Weight kg
	d	D	D ₁	D ₂	A		C	C ₀	
IL 13-1249 087	10	24	21	19,5	65	15000	2860	1160	0,160
IL 13-0010 092	10	22	19	16	95	15000	2650	1060	0,150
IL 13-0013 744	11	25	21	-	109	15000	2810	1080	0,190
IL 13-0020 824	11	25	21	-	98	15000	2810	1080	0,180
IL 13-0029 170	10	22,4	20,5	-	95	15000	2860	1160	0,150
IL 14-0028 695	11	24,9	22,9	-	95	15000	3900	1660	0,170
IL 13-1257 771	10	24	21	19,5	66	16000	2860	1160	0,110

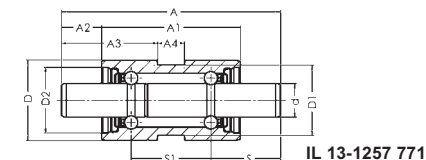

IL 13-1257 771

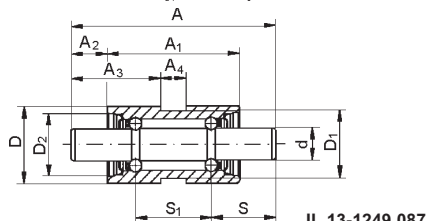

IL 13-1249 087

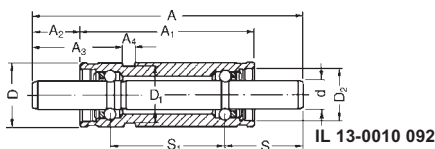

IL 13-0010 092

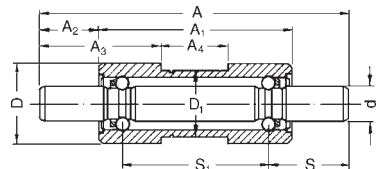

IL 13-0013 744
IL 13-0020 824

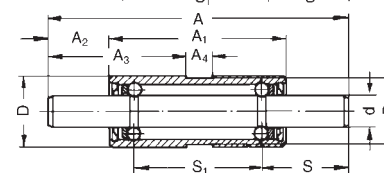

IL 13-0029 170

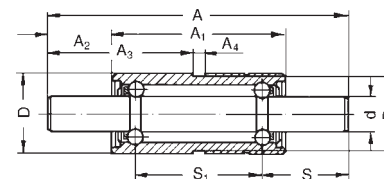

IL 14-0028 695

Rotor spinning frames

Cotton mills

Chapter 6-10

Chapter 6-11

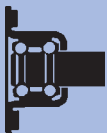

TEXParts Bearing units SR and ZB

TEXParts Bearing units ZL

Application

For rotor spinning frame
BD 200, types
M, R, RC, RCE and S

Types Ref.no.	Dimensions in mm				Weight kg	
	A	A ₂	D ₂	d		
SR 23-0953 801 ¹⁾	84	19,7	-	7,8	26	0,111
SR 23-0953 901 ²⁾	84	19,7	-	7,8	26	0,118
ZB 7-0009 023	34,4	13	43	11,2	-	0,080

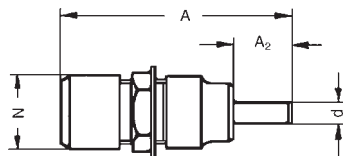

SR 23-0953 801¹⁾
SR 23-0953 901²⁾

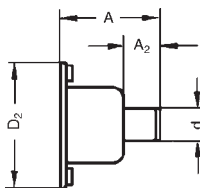

ZB 7-0009 023

See also chapter 2
page 16.

Rotor spinning frames

Cotton mills

Chapter 6-12

Types Ref.no.

ZL 1828-1258 200

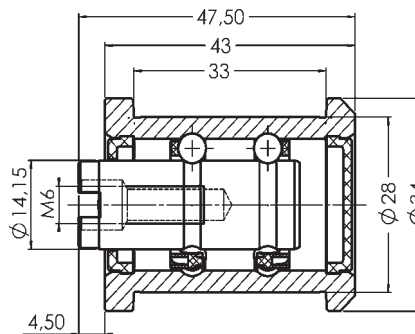

ZL 1828-1258 200

Application

For rotor spinning frame
Schlafhorst
belt guide roll

Rotor spinning frames

Cotton mills

Chapter 6-13

Bearing units for texturizing aggregates, counter rolls, separator rolls, lubricating equipment and accessories for separator rolls	1
False twist assemblies FL	2
Counter rolls CK with bearing units FL	4
Counter rolls CK with bearing units FL	6
False twist assemblies FL	7
False twist assemblies FL	8
False twist assemblies FL Guidici	9
Separator rolls VR	10
Separator rolls VR	12
Bearing unit CK 15	14
Lubricating equipment and accessories for separator rolls VR	15



TEXParts False twist assemblies FL



Application

Bearings for friction
texturing assemblies.

Types Ref.no.	Dimensions in mm						SW	A	A ₁	A ₂	A ₃	A ₄	A ₅	S	S ₁	Load fig. in N		Weight kg
	d	d ₁	D ₁	G	C	C ₀												
FL 66- 0013 055 ¹⁾	8,1	M5	24	M 21x1	22	125		77	53	31,5	27	4,5	67,5	30	1660	765	0,130	

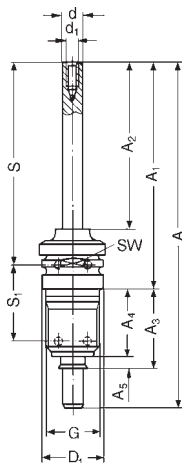

FL 66-0013 055

Texturizing machines

Filament processing mills

Chapter 7-2

¹⁾ Delivery until using-up of stock.

Chapter 7-3



TEXParts Counter rolls CK with bearing units FL



Application

As counter roll in magnetic and friction assemblies. Counter rolls serve to stabilize the tangential belt in texturizing machines.

Key face 22 mm

Texturizing machines

Filament processing mills

Chapter 7-4

Types Ref.no.	Weight kg	Remarks
CK 668-0017 992	0,178	Counter roll with bracket is composed of CK 668-0012 083, bracket CHT-1251 471, nut FMT-0010 953, and cap FKA-0019 933

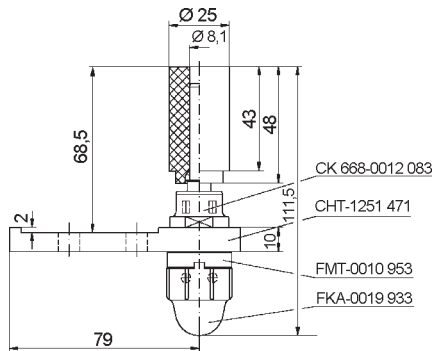

CK 668-0017 992

Types Ref.no.	Weight kg	Remarks
CK 668-0012 083	0,135	Counter roll with lap protection and wharve dia.25 mm, with wharve CWL-0012 117
CWL-0012 117	0,020	Wharve for CK 668-0012 083

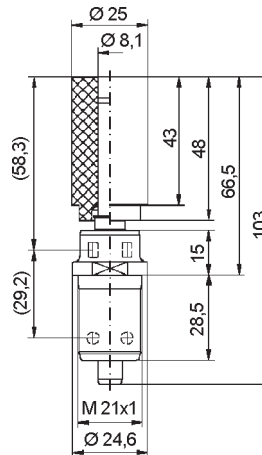

CK 668-0012 083

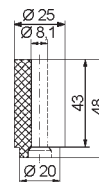

CWL-0012 117



TEXParts Counter rolls CK with bearing units FL

TEXParts False twist assemblies FL



Application

As counter roll in friction assemblies.

Key face 22 mm.

Texturizing machines

Filament processing mills

Chapter 7-6

Types
Ref.no.

Weight
kg

Remarks

CK 668- 0018 773 0,135 Counter roll complete
Bearing for counter
roll is FL 668-0014 279.

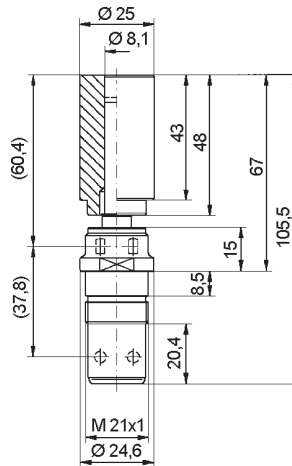

CK 668 -0018 773

Types
Ref.no.

Load fig. in N
C C₀

Weight
kg

FL 15- 1252 742 3320 1340 0,420
FL 15- 1252 743 3320 1340 0,200
FL 15- 1254 440 3320 1340 0,420
FL 15- 1254 441 3320 1340 0,200

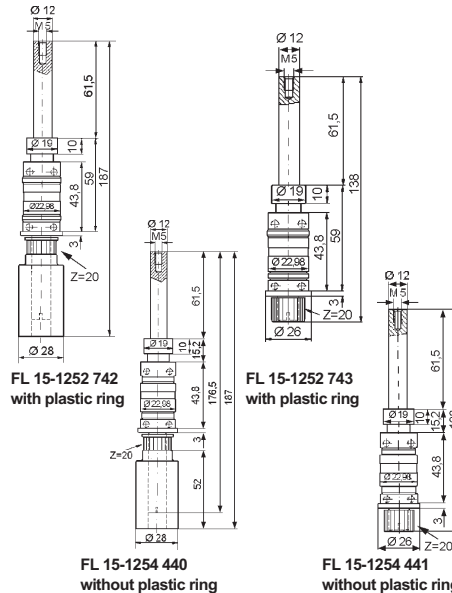

FL 15-1252 742
with plastic ring

FL 15-1252 743
with plastic ring

FL 15-1254 440
without plastic ring

FL 15-1254 441
without plastic ring

Application

Bearing Units for friction texturizing assemblies.

Texturizing machines

Filament processing mills

Chapter 7-7



TEXParts False twist assemblies FL

Application

Bearing Units FL 15 for friction texturizing assemblies.

Types Ref.no.	Load fig. in N		Weight kg
	C	C ₀	
FL 15- 0029 812	3320	1340	0,230
FL 15- 0033 442	3320	1340	0,255

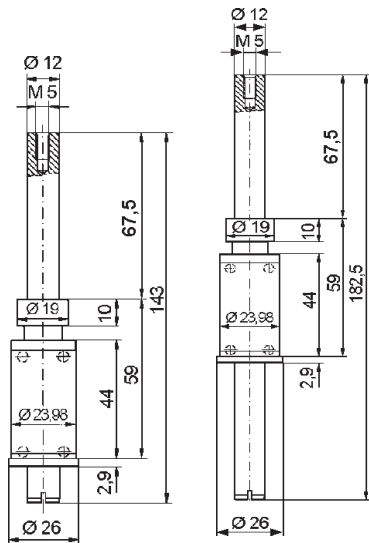

FL 15- 0029 812

FL 15- 0033 442

Texturizing machines

Filament processing mills

Chapter 7-8

TEXParts False twist assemblies FL Guidici

Types Ref.no.	Load fig. in N		Weight kg
	C	C ₀	
FL 18-1252 061	4620	1960	0,400
FL 18-1252 062	4620	1960	0,364

FL 18-1252 061	4620	1960	0,400
FL 18-1252 062	4620	1960	0,364

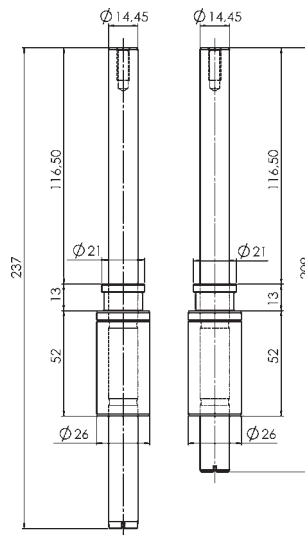

FL 18-1252 061

FL 18-1252 062



Application

Bearing units FL 18 for friction texturizing assemblies.

Texturizing machines

Filament processing mills

Chapter 7-9

TEXParts Separator rolls VR

Application

Separator rolls for use in draw roll systems on draw twisters and draw winders.

Shell is non-detachable.

Lubricating and lubricating equipment for separator rolls see chapter 8 page 8 and chapter 8 page 18.

Draw twisters
Draw winders

Filament processing mills

Chapter 7-10

Types Ref.no.	Version	°C on roll surface ¹⁾	Dimensions in mm		d	H	E	F	Weight kg	Remarks
			d ₂	d ₁						
VR 1-0964 428	A	... 70	21,2	26	8	76,5	22	58	0,091	1) Threads run on a hard-chrome plated outside surface; „orange-peel“ effect of surface provides optimum conditions of friction.
VR 4-0964 445	A	... 70	21,2	26	8	95,8	22	77	0,123	
VR 3-0964 435	B	... 70	21,2	26	8	63	12	47	0,082	
VR 7-0964 447	B	... 70	21,2	26	8	76,5	14,5	58	0,100	
VR 11-0964 434	B	... 70	21,2	26	8	95,8	14,5	77	0,132	
VR 2-0964 430	C	... 70	21,2	26	M8	83	28	58	0,092	
VR 6-0964 442	C	... 70	21,2	26	M8	103	28,5	77	0,124	
VR 8-0964 426	D	... 70	21,2	-	8	59	19,5	43	0,070	
VR 3-0025 015	A	... 70	21,2	26	8	52,5	22	37	0,060	
VR 4-0964 438	A	70 ...130	21,2	26	8	95,8	22	77	0,122	
VR 3-0964 429	B	70 ...130	21,2	26	8	63	12	47	0,082	
VR 7-0964 441	B	70 ...130	21,2	26	8	76,5	14,5	58	0,100	

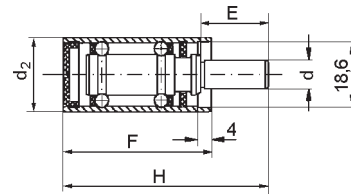
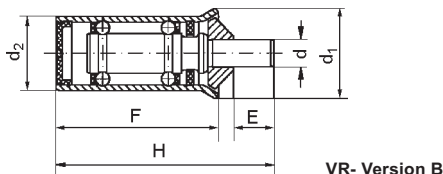
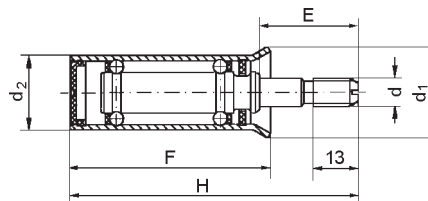
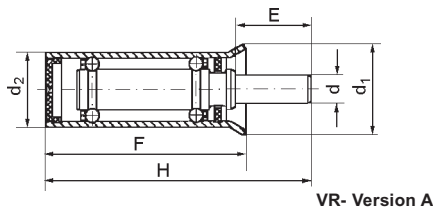

VR- Version C

VR- Version D
Chapter 7-11

TEXParts Separator rolls VR



Application

Separator roll for use in draw roll systems on draw twisters and draw winders.

Types Ref.no.	°C on roll surface	Dimensions in mm		d	H	E	F	Weight kg	Remarks
		d ₂	d ₁						
VR 7-0000 320 ¹⁾	... 70	22	26	8	76,5	14,5	58	0,124	Complete separator roll
CK 12-0000 319	-	-	-	8	76,5	14,5	58	0,077	Bearing for VR 7-0000 320

Shell is detachable.

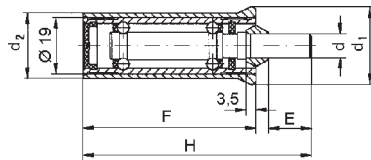

Separator roll VR 7-0000 320

Draw twisters
Draw winders

Filament processing mills

Chapter 7-12

¹⁾ The plastic cover with reference number VDE 0000 887 must be used for the VR 7-0000 320 and the CK 12-0000 319.



TEXParts
Bearing unit CK 15

TEXParts
Lubricating equipment
and accessories
for separator rolls VR



Application

Bearing Unit CK 15 as apron roller in friction texturizing assemblies.

Types
Ref.no.

CK 15-1252 746

Weight
kg

0,112

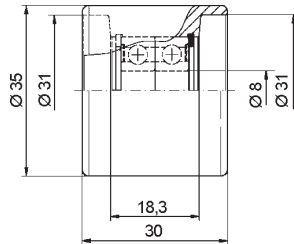

CK 15 - 1252 746

Texturizing machines

Filament processing mills

Chapter 7-14

Item

Types
Ref.no.

For
VR types

Lubricating device **1251 491**

Pin **0994 231**

Plastic cover¹⁾
 (ivory) **VDE-0911 030**

Plastic cover¹⁾
 (red) **VDE-0002 607**

for all VR - types

VR 1 to VR 11
 for temperatures
 up to 70° C
 on roll surface

VR 3, VR 4 and
 VR 7 for
 temperatures
 between 70°
 and 100° or
 130° C resp.

¹⁾ for spare orders.

Application

For lubricating separator rolls VR.

For information on lubricating intervals and lubricants see chapter 8 page 8.

Draw twisters
Draw winders

Filament processing mills

Chapter 7-15

Lubrication and servicing, testing and measuring bearing units for textile machines	1
Lubrication of products for textile machines	2
Viscosity classes	9
Lubricating apparatus 1254 106 for lubrication of TEXParts spindle bearing units	10
Lubrication of spindle bearing units SMM BI-FLEX	12
Ordering top roller cots	13
Tension pulleys	16
Bearing units for texturizing aggregates	17
Separator rolls VR	18

Lubrication of products for textile machines

Types	Lubri- cant	Quantity of Lubricant g/bearing		Speed max. rpm.	Lubrication intervals Operating hrs.	
		min.	max.		h	Years
Tape tension pulleys SR						
SR 7-0030 782	A/B	0.8	1.2	6 000	30 000	5
SR 9-0953 201	A/B	0.8	1.2	6 000	30 000	5
SR 23-0954 031	A/B	0.8	1.2	10 000	18 000	3
SR 23-0954 032	A/B	0.8	1.2	10 000	18 000	3
SR 23-0954 034	A/B	0.8	1.2	5 000	18 000	3
SR 23-0954 035	A/B	0.8	1.2	5 000	18 000	3
SR 28-0012 473	M	0.6	1.0	15 000	12 000	2
SR 28-0012 474	M	0.6	1.0	15 000	12 000	2
SR 28-0015 799	M	0.6	1.0	20 000	12 000	2
SR 45-0028 044	A/B	0.8	1.2	16 000	12 000	2
SR 45-0008 937	A/B	0.8	1.2	16 000	12 000	2
SR 5047 -1255 461	M	0.7	0.9	10.000	24.000	4
SR 5047 -1255 699	M	0.7	0.9	10.000	24.000	4

Contact roll assemblies AR for ring frames with tangential belt drive

AR 28	A/B	0.6	1.0	> 15 000	6 000	1
				15 000	9 000	1,5
				12 000	12 000	2
AR 45	A/B	1.2	1.4	8,500	18 000	3
				12 000	12 000	2
AR 5047 (belt width ~40mm max.)	M	0.7	0.9	10 000	24 000	4
AR 3528 (belt width 20mm max.)	M	0.6	0.8	12 000	18.000	3

AR for ring frames with sectional drive or belt width up to 16mm max.

AR 50-0027 195	A/B	1.2	1.4	8 500	18 000	3
				12 000	12 000	2
AR 50-0027 196	A/B	1.2	1.4	8 500	18 000	3
				12 000	12 000	2
AR 50-1246 555	A/B	0.8	1.2	12 000	12 000	2
				M	0.7	0.9

Types	Lubri- cant	Quantity of Lubricant g/bearing		Speed max. rpm.	Lubrication intervals Operating hrs.	
		min.	max.		h	Years

Bearing units

SR 23-0008 620	A/B	0.8	1.2	20 000	18 000	3
SR 23-0020 650	A/B	0.8	1.2	20 000	18 000	3
SR 23-0954 030	A/B	0.8	1.2	20 000	18 000	3
SR 23 - with black cap	A/B	↑ cap ¹⁾ : full		20 000	6 000	1
SR 24 - with black cap	A/B			20 000	6 000	1
SR 35 - with black cap	A/B	↓ lubrication		20 000	6 000	1
FR-	A/B			0.8	1.2	15 000
ZB 7	A/B	0.8	1.2	8 000	18 000	3
ZL 7	A/B	0.8	1.2	8 000	18 000	3
ZL 17	E	0.5	-	8 000	6 000	1
DR-	A/B	0.6	1.0	8 000	12 000	2
DR 1922-0958 551	A/B	0.8	1.2	8 000	12 000	2

¹⁾ Lubrication interval: every 6.000 operating hrs. 4 to 5 rotations at the cap.

Lubricant

- A** **TEXParts grease TG 2** - available in containers of 5 kg - Ref. No. **0026 877**
- B** **A high grade lithium base rolling bearing grease** having the following properties: Worked penetration: ~265 to 295 mm/10 at 25° C, Dropping point: ~190° C; Worked temperature range: -30° to +120° C
- C** **TEXParts grease TG 5** - available in containers of 5 kg - Ref. No. **0026 878**
- D** **A (Ba- or Ca-) complex soap grease** having the following properties: Worked penetration: ~220 to 300 mm/10 at 25° C; Dropping point: > 200° C; Worked temperature range: ~ -30° C to 150° C
- E** **Mystik JT-6**, produced by Messrs. Hermann Höfeler
Chemisch-Technische Fabrik, P.O. Box 10 08 03, 42608 Solingen
- M** **Asonic GHY 72** produced by Klüber Lubrication München KG,
Geisenhausener Straße 7 · 81379 München

Types	Lubri- cant	Quantity of Lubricant g/bearing	Speed max. rpm.	Lubrication intervals Operating time h	years
-------	----------------	---------------------------------------	-----------------------	---	-------

Top roller bearings for ring and speed frames

Top rollers LP

LP 1002	C/D	full lubrication	< 500	50.000	8
LP 302 LP 1016, LP 1017 LP 1014, LP 1015	↕ C/D	↕ full lubrication	↕ < 500	↕ 30.000	↕ 5
LP 1003, LP 303	Lifetime lubricated, maintenance free				

Bottom roller bearings UL

UL	C/D	full lubrication	< 500	3 000	0,5
----	-----	------------------	-------	-------	-----

Lubricant

- C** **TEXParts grease TG 5** - available in containers of 5kg - Ref. No. **0026 878**
- D** **Barium- or Calcium- complex soap grease** having the following properties:
Worked penetration: ~220 to 300 mm/10 at 25° C;
Dropping point: > 200° C; Worked temperature range: ~ -30° C to 150° C

Spindle bearing units

Types	Lubri- cant	Operation	Lubrication intervals Operating hrs. h	Viscosity class to ISO
CS1 CS1 12 HF 1 HF 21	G G G	↕ with ring and traveller spindle speed up to 18.000 min ⁻¹ ↕ exceeding 18.000min ⁻¹	20 000 12 000	VG 10 VG 46 ¹⁾ VG 10 VG 10
HF3	G	↕ with ring and traveller	15 000	VG 10
HF3²⁾		↕ with suppressed balloon	10 000	VG 68
HF 44 HZ 440	G G	↕ with ring and traveller ↕ without ring and traveller	15 000 10 000	VG 10 VG 10
HF 44²⁾	G	↕ with suppressed balloon	10 000	VG 68

The oil level should be checked on a random sample of spindles after half the number of operating hours shown.

The roller bearing should be thoroughly coated with oil before putting the spindle into service, and also at each relubrication operation!

¹⁾ ISO VG 46 for all yarn counts (for finer yarn counts -higher than Nm 24- ISO VG 22 can also be used)

²⁾ Special execution of damping spiral

Lubricant

- G** **Solvent refined high-grade oil** - with good anti-wear properties and containing anti-oxidant and anti-corrosion additives as per DIN 51517 - CLP.

Spindle Bearing units Types	Lubricant	Lubric. interval after operating hrs. For axial load A ¹⁾		Viscosity class to ISO
		<3,5 daN h	>3,5 daN h	

HZ 33 HZ 35, HF 45	G	↑ 10 000	7 000	VG 10
	G			VG 22

Spindle Bearing units Types	Lubricant	Lubric. interval after operating hrs. For axial load A ¹⁾				Viscosity class to ISO
		<3,5 daN h	3,5-5daN h	5-8 daN h	>8 daN h	

HZ 55	G	↑ 10 000	-	-	-	VG 10
			-	7 000	-	-
HZ 66, HZ 68	G	↑ 10 000	-	5 000	-	VG 22
			-	7 000	4 000	-
HZ 77	G	↑ 10 000	-	-	4 000 ²⁾	VG 46
			-	7 000	4 000	-
			-	-	4 000 ²⁾	VG 22
			-	-	-	VG 46

The oil level should be checked on a random sample of spindles after half the number of operating hours mentioned. The types HZ 33, HZ 35 and HF 45 are provided for application in double twist spindles.

With types HZ 55 to HZ 77, for spinning or twisting with suppressed yarn balloon (e.g. with spinner or twister head on the spindle) use oil with the viscosity class ISO VG 100.

The roller bearing should be thoroughly coated with oil before putting the spindle into service, and also at each relubrication.

¹⁾ Axial Load A = Weight of full bobbin plus spindle blade assembly.

²⁾ Carry out an initial oil change after spindles have been run in for 50 hours.

Lubricant

G Solvent refined high-grade oil - with good anti-wear properties and containing anti-oxidant and anti-corrosion additives as per DIN 51517 - CLP.

Identification of spindle bearing sizes and immersed depth of spindle blade

Spindle bearing unit sizes may be identified from the following dimensions:

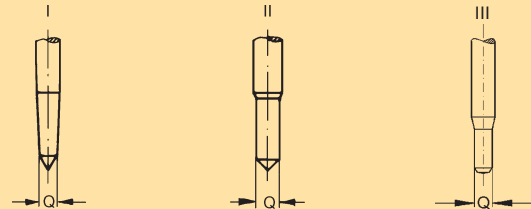

Conical foot shape (I) with blade tip

Cylindrical foot shape (II) with tapered blade

Cylindrical foot shape (III) with spherical tip

„P“ = blade diameter at roller bearing height

„R“ = external diameter of spindle bearing head

„Q“ = diameter of shaft foot.

Spindle Type	Foot shape	P	R	Q	Oil filling Immersed depth of spindle blade in mm max. min.	
					max.	min.
CS1	III	6.8	16.0	4.5	70	50
CS1 12	III	6.8	16.0	4.5	80	60
HF1	I	6.8	16.0	4.5	80	50
HF 21	I	7.8	17.5	4.5	80	50
HF 3	I	8.8	21.7	5.5	100	70
HZ 33	II	8.8	21.7	5.45	95	65
HZ 35	II	8.8	21.7	7.95	100	70
HF 44, HZ 440	II	10	23.8	6.45	110	70
HF 45	II	10	23.8	7.95	110	70
HZ 55	II	12	28.2	7.95	125	90
HZ 66	II	14	32.5	8.95	145	90
HZ 68	II	14	32.5	10.95	145	90
HZ 77	II	16	37.8	10.95	190	120

Types VR	Lubri-cant	Speed min ⁻¹	Lubrication intervals Operating hrs. h	°C on outside of shells ¹⁾ of VR/CK
----------	------------	-------------------------	--	--

Separator rolls VR and bearing unit CK 12 for temperatures up to 70° C

VR 1-0964 428, VR 2-0964 430	↑	up to 10 000	12 000	up to 70°
VR 3-0964 435, VR 4-0964 445		up to 15 000	10 000	up to 70°
VR 6-0964 442, VR 7-0000 320 ²⁾ H		up to 20 000	7 000	up to 70°
VR 7-0964 447, VR 8-0964 426		up to 25 000	5 000	up to 70°
VR11-0964 434 CK12-0000 319		up to 30 000	4 000	up to 70°

Separator rolls VR for temperatures between 70 to 260° C

VR 3-0964 429 ³⁾ , VR 4 -0964 438 ³⁾ J	↑	up to 15 000	2 000	70-100
VR 7-0964 441 ³⁾ J		up to 20 000	1 500	70-100
		up to 10 000	700	100-130
VR 50-0964 450 J	↓	up to 15 000	2 000	100-200 ⁴⁾
		up to 15 000	700	200-260 ⁵⁾

¹⁾ In the temperature range between 70° - 80° C on outside surface of the shell, the lubricating intervals have to be reduced to 2/3 of the indicated values.

²⁾ Speed range up to 20.000 min⁻¹

³⁾ These types are provided with a red plastic cap.

⁴⁾ Outer ring temperature <100° C.

⁵⁾ Outer ring temperature <130° C.

Lubricant

H Isoflex Super LDS 18 Dispersion 25 S
- available in containers of 1l
Attention! Inflammable, dangerous material class A II. Please observe warning advice.

J Unisilkon TK 44 N0 - produced by: Klüber Lubrication München KG; Geisenhausener Straße 7 · 81379 München

Types Rotor spindle TL	Lubri-cant	Lubrication intervals in operating hrs. h at rpm.	Quantity of Lubricant
------------------------	------------	---	-----------------------

60 000 80 000

Oil-lubricated rotor spindle:

TL 226-1245 856 ¹⁾	L	2 000	1 500	0,25 cm ³
-------------------------------	---	-------	-------	----------------------

¹⁾ Combine relubrication with cleaning of by-pass filter. The by-pass filter (filter cover) covers the opening above the relubricating bore of the rotor spindle housing.

TL 226

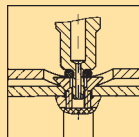

Shape of lubricating hole

Lubricant L:

Oil Isoflex PDP 65

- available in containers of 1 l

Viscosity classes

Viscosity classes according to ISO	Mean kinematic viscosity at 40,0° C mm ² /s (cSt)	Limits of kinematic viscosity at 40,0° C mm ² /s (cSt)	
		min.	max.
VG 10	10	9.0	11.0
VG 22	22	19.8	24.2
VG 46	46	41.4	50.6
VG 68	68	61.2	74.8
VG 100	100	90.0	110.0

Under the international SI system, kinematic viscosity is expressed in m²/s. The relationship between this unit and the figures given in Centistokes (cSt) is 10⁻⁶ m²/s = 1 mm²/s = 1 cSt.

Thus, the mm²/s column in the table corresponds to the values Centistokes (cSt).

Lubricating apparatus 1254 106 for lubrication of TEXParts spindle bearing units

The lubricating apparatus 1254 106 is conceived for the original lubrication and the maintenance of TEXParts spindle bearing units CS, HF, and HZ. It is suitable for all spindle sizes. The lubricating pump is activated by an electric motor drive system.

For the description of the components please see the figure below.

- | | | |
|-----------------------------------|---|------------------------|
| 1 Drainage screw
for fresh oil | 6 Control unit | 10 Connecting plug |
| 2 Fresh oil tank | 7 Place to deposit
top part of spindle | 11 Manometer |
| 3 Used oil tank | 8 Receiver for nozzle | 12 Oil level display |
| 4 Return oil tube (thick) | 9 Filling tube
for fresh oil | 13 Lubricating nozzle |
| 5 Fresh oil tube
(thin) | | 14 Lubricating adapter |

The operation principle of the spindle lubricating apparatus is based on the supply of clean oil and the suctioning of used oil at the same time.

The two tanks, one for new oil (2) and one for used oil, have a capacity of 20l each. Transparent tubes (4) and (5) are connecting each tank with the lubricating nozzle (13), which is provided with a lubricating adapter, matching the respective spindle type and size.

When the lubricating adapter is inserted into the spindle bearing unit, oil channels will open automatically and by activating the pump the spindle bearing unit can be filled up with new oil. During relubrication the new oil fed in will push the used oil out of the spindle bearing unit, due to its sealing system. The used oil will be returned to the used oil tank through the transparent tube. By this process a thorough rinsing of the spindle bearing unit can be assured as well as the coating of the roller bearing with new oil. In addition the required oil level will adjust automatically.

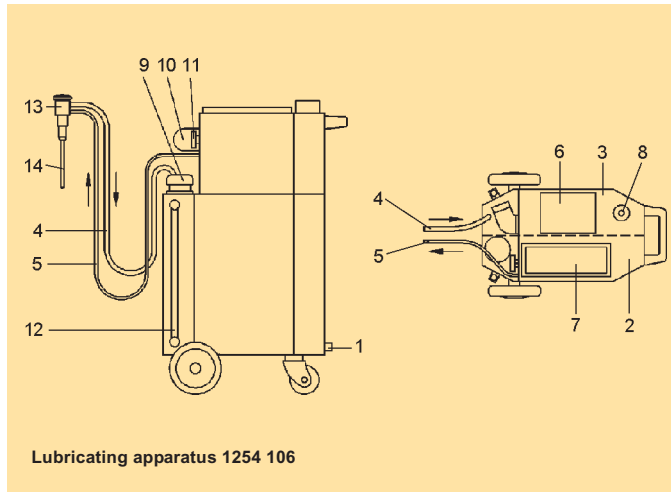

Lubrication of spindle bearing units SMM BI-FLEX

Types: Oil filling amount (ccm)

SMM- 32	28 ccm
SMM- 42	26 ccm

Viscosity and lubricating interval

All spindles with SMM BI-FLEX Spindle bearing units are developed and manufactured according to customer's demands.

For each application a special decision has to be made considering spindle speed and load, what kind of viscosity and lubrication interval is needed to achieve always the best possible spindle performance.

Lubricant

Lubricant only with a solvent refined high-grade oil with good anti-wear properties and containing anti-oxidant and anti- corrosion additives.

The roller bearings should be thoroughly coated with oil at each relubrication.

Further informations regarding the lubrication of SMM spindle bearing units BI-FLEX upon request.

Ordering top roller cots

Since there is a wide range of cot types and qualities to suit the many different mill requirements, no specific cot quality can be recommended. The most influential factors in cot performance are the spinning room temperature and humidity, the load used on the top roller, and the material being processed. Instructions for the use of synthetic cots are provided by the suppliers.

Upon customer's request, TEXParts will supply top rollers with cot, ready ground, for immediate installation in the weighting arm. Cots from various manufacturers are available in a wide range of qualities or shore hardnesses. Different types can be supplied with bushes for press-fitting on the outer ring.

When ordering TEXParts top rollers with cots, please state:

- Ref. No. of basic top roller type (without cot)
 - Quality of cot or shore hardness
 - Cot diameter (ready ground)
 - Cot width
 - Type of edge (straight, bevelled or round bevelled)
- The edges of cots are shaped differently according to the manufacturers unless the customer explicitly requires a specific shape or dimension.
- In the case of recessed apron top rollers: recess width and recess depth (see chapter 9, page 89).

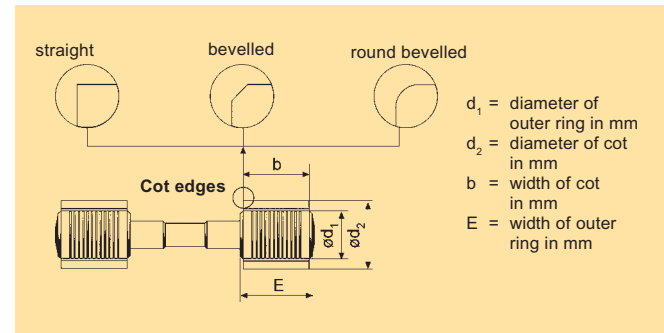

Hardness of the cots

The most commonly used hardness range for cots is from 63° to 83° Shore. The customary type of Shore sclerometer (according to DIN 53 505) can be used for testing the Shore hardness of synthetic cots.

Fitting the cots

When fitting or removing the cots, make sure that no axial pressure is applied to the ball bearings of the top roller.

Cots with metal or plastic bushes

Fitting and removing these cots is done mechanically or pneumatically with commercially available fitting and removal press devices. For fitting the cots, the press devices recommended by the cot manufacturers should be used. In no case an expander cone should be used to press-fit the cots with metal bushes.

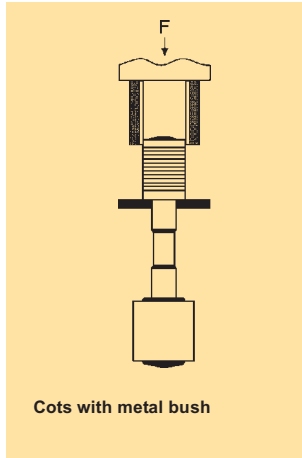

Cots with metal bush

Fitting cots

Removing used cots

Cots with metal or plastic bushes

Used cots with metal or plastic bushes are removed with a pressing tool. No special cleaning is required after removing an old bush and prior to mounting the new bush.

Lubrication of bottom roller bearings

TEXParts bottom roller bearings are being supplied ready-greased with TEXParts grease TG 5, or ungreased on customers' demand. Details for relubrication (see chapter 8, page 4).

Relubrication of all types of TEXParts bottom roller bearings should be carried out with a grease gun by pressing the grease slowly into the bearing while the machine is running. Types and Ref. No. of TEXParts grease guns and nozzles can be seen on chapter 4 page 10.

For information on lubricants and lubricating intervals see chapter 8 page 4.

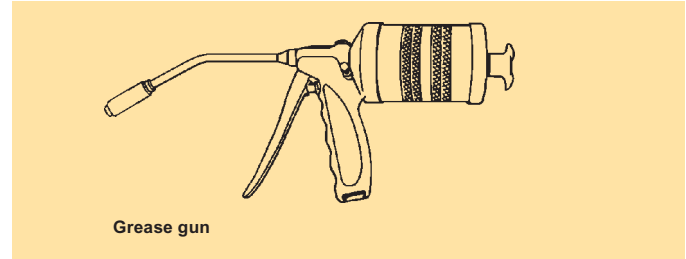

Grease gun

Tension pulleys

TEXParts makes tension pulleys or contact roll assemblies with 2-line ball bearings or with ball/roller row for belt drives in various textile machines.

These tension pulleys can be used for comparable applications in other fields of machine and equipment engineering too.

For further information on the various types see the following pages in this almanac:

Type	Page	Used in
CK 11-	chapter 2 page 12	OE-rotor spinning frames
CK 668-	chapter 7 page 4	Filament processing
SR 23-	chapter 2 pages 14+16	General mechanical engineering
FR 232-	chapter 2 page 14	General mechanical engineering
SR 5047-	chapter 2 page 10	Spindle drives

Texturizing processes are applied to give synthetic filaments specific properties and one of them - the false twisting method - is used to produce such varieties as high- or low-elasticity yarns, bulked yarns, or low-twisted torque yarns.

TEXParts supplies integrated bearing units for friction texturizing, and for counter rolls and support rolls. If required, these bearing units are fitted with drive elements such as wharves and toothed pulleys or made up into ready-to-install units. Apron rollers for apron units round off the product range of the bearing units for texturizing aggregates.

The integrated design of these bearing units with close bearing clearing tolerances allows low bearing pitch circle diameters for low bearing friction moment to be combined with high shaft and bearing stiffnesses for low-vibration operation.

For the counter rolls, the combination of ball and roller bearing ensures long service life plus compact dimensions.

The following list shows how the various bearing models are used:

TEXParts bearing Model series	Bearing unit for	Page
FL 66	Friction texturizing aggreg.	chapter 7 pages 2 - 3
CK 668	Counter rolls	chapter 7 pages 4 - 5
CK 15	Apron roller	chapter 7 page 14

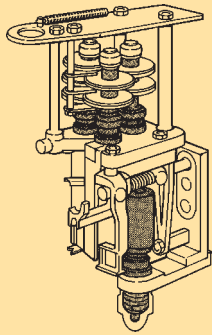

Friction texturizing unit
with false twist bearing unit FL

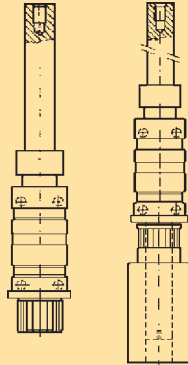

False twist bearing unit FL

The cylindrical inner shape of the outer ring and even distribution of the lubricant permit full use of the lubricant supply for the two ball bearing rows and hence a long service life. A flexurally stiff axle assures very quiet running.

A complete list of the TEXParts's available range of VR separator rolls can be found on chapter 7 pages 12 - 16. See chapter 8 page 10 for information on lubrication.

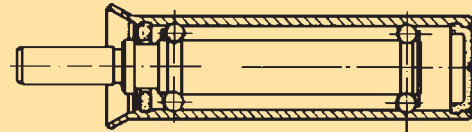

Separator roll VR

Separator rolls VR

Polyamide and polyester filaments and similar synthetics are subjected to a drawing process on draw twisters or draw winders. The process may be either cold drawing or hot drawing and for both of these suitable separator rolls are supplied by TEXParts.

Design features:

The separator rolls are designed as bearing outer rings with low weight and high hardness for reducing slip between the filament and the roll, particularly during machine operation, and for preventing damage to the working surface when laps form.

The working surfaces of the separator rolls are hard-chrome-plated with a selective and orange-skin-like surface structure for ensuring optimum friction characteristics between the filament and the working surface. The ball bearings are designed for high speeds and have a dispersion lubrication system to obviate running-in characteristics with increased friction moment and persistent grease working resistance.

Recommendations for optimized spinning with spindles and weighting arms	1	Series PK 1500 weighting arms for cotton speed frames	55
TEXParts spindle bearing units for spinning and twisting spindles	2	Drawing frame sliver feed	56
Applications for TEXParts spindle bearing units	5	Draft ratios	56
Tubes and bobbins	6	Draft fields	57
The functions of ring and traveller	8	Roller loading	59
Spindle drive in ring frames	15	Top apron cradle system	60
Draft sizes series PK 3000 weighting arms	18	Opening X at apron release point	61
for cotton ring frames pneumatic load principle		Top aprons for PK 1500	62
Draft fields	19	Top roller cots	62
Roller loading	21	Bottom apron nose bar	63
Partial load relieve	22	Condensers	63
Top apron cradles and top aprons	23	Series PK 6000 weighting arms for worsted ring frames	66
Opening X at apron release point	25	pneumaticload principle	
Bottom aprons	27	Draft fields	67
Top roller cots	27	Draft sizes	67
Series PK 2000 weighting arms	28	Roller loading	69
for cotton ring frames		Top apron cradle system	71
Draft sizes	29	Opening X at apron release point	71
Draft fields	30	Top rollers and cots	73
Roller loading	32	Mono-clearer roller system	74
Top apron cradles and top aprons	35	Recessed rollers	74
Opening X at apron release point	37	Bottom apron nose bar	75
Top roller cots	41	Condensers for PK 6000	75
Bottom Aprons	41	Series PK 1601 weighting arms for worsted ring frames	77
Series PK 5000 weighting arms	42	Draft sizes	77
for cotton speed frames pneumatic load principle		Draft fields	78
Sliver	44	Roller loading	80
Draft sizes	44	Top apron cradles	80
Draft fields	44	Partial load relieve	81
Roller loading	46	Opening X at apron release point	82
Top apron cradle system	49	Top roller cots	82
Opening X at apron release point	49	Recessed rollers	83
Top aprons for PK 5000	51	Bottom apron nose bar	85
Top roller cots	51	Condensers for PK 1601	86
Bottom apron nose bar	52	For all TEXParts draft systems	87
Condensers	52	survey of outer ring and cot dimensions	
		Bottom roller bearings	90
		CONVERSIONPlus	91

TEXParts spindle bearing units for spinning and twisting spindles

TEXParts supplies suitable spindle bearing units for a wide range of applications of modern spinning and twisting machines. These machines are equipped with TEXParts HF/HZ and BI-FLEX spindle bearing units known all over the world and proved under industrial conditions. Additionally, they are equipped with the high-performance spindle bearing units, CS1-series for cotton and worsted ring frames, which meet all requirements for modern spindles due to an innovative, function-orientated new bearing principle.

Advantages of TEXParts spindle bearing units

• Outstanding running properties

All TEXParts spindle bearing units are equipped with metal-elastic spring elements thus giving radial resilience to the bearing places. So, the top part of the spindle can rotate - together with the unbalanced bobbin - around the common axis through the centre of gravity, thus minimising bearing forces and spindle vibrations. In addition, the spring elements ensure that the top part of the spindle is always returned to the initial position centred on the spinning ring after being moved. The damping system of the TEXParts spindle bearing units showing no wear during operation is a further feature. It has metal strip spirals filled with oil and in some cases grease gap dampers which are optimised for specific applications and which effectively suppress spindle vibrations over the whole speed range.

The carefully matched spring and damping qualities of TEXParts spindle bearings guarantee outstanding running properties in the spindles.

• Top spindle speeds

TEXParts offers two bearing principles for spinning and twisting spindles:

Single-elastic spindle bearings

In these bearing units, either the footstep bearing is kept radially movable by a metal spring (type TEXParts CS1, HF, HZ). Damping in the form of an oil-filled metal spiral forms an integral property of the spring system. The single-elastic bearings are of robust design and set the standard for the majority of applications in spinning and twisting. They can be used in conjunction with high-quality upper parts and tubes as well as for high-speed applications.

Double-elastic spindle bearings

These bearings are additionally equipped with a second metal spring which affords radial resilience in the neck roller bearing (type TEXParts SMM BI-FLEX). This second spring also has a damping function being free of wear (oil/grease damper).

The double-elastic spindle bearing units allow the spindle upper part to shift the centre of the gravity axis even more exactly towards the rotation axis, thus achieving a major reduction in bearing forces and noise level. The double-elastic spindle bearing units therefore are the ideal choice mainly for the high and maximum speed range. Their mechanical design permits speeds far above the limit imposed by the ring/traveller system.

• Quiet running behaviour

The high precision of the TEXParts spindle bearings and the system-inherent low bearing forces ensure low-noise spindle operation over the full speed range. A further advantage in this respect results from the double-elastic spindle bearing systems, which generate lower acoustic pressure levels thanks to their lower bearing forces, and furthermore greatly reduce the transmission of structure-related vibration to the machine. For this reason, the use of double-elastic spindle bearing units is recommended whenever the noise level is a major criterion for the assessment of the machine.

• Minimised energy requirement

The oil-lubricated neck bearing and footstep bearing of TEXParts spindle bearings are precisely matched to the blade of the spindle upper part for good bearing performance, and ensure minimum bearing friction in all speed ranges. Furthermore, the low dynamic bearing forces mean that roller bearings and wharves can be made smaller, and in turn permit low belt speeds and tension roller speeds. This results in considerable energy saving of the machine.

The model CS1 has specially been designed for high-speed cotton spinning spindles. The small head diameter allows an extremely small wharve diameter up to 18.5 mm connected with still more energy consumption.

• High centring precision

The centring of the spindle inside the ring is a crucial factor for minimising breakage rates and maximising cop filling.

Here TEXParts spindle bearing units offer ideal conditions:

- the spring elements of the spindle bearing counteract every movement of the spindle upper part with sufficiently high resetting forces to restore it quickly to its initial centred position;

- the flange underside and the centring collar of the spindle bearings are made with high precision and fully aligned with the axis of the upper part.

- **Long-life**

Minimised bearing forces plus high manufacture precision of the TEXParts spindle bearing units are the basis for long-life. The robustly designed elements of the spindle bearings also ensure the bearings to withstand occurring stresses such as during deceleration and doffing. Damping oil inside the spindle bearing serves for permanent lubrication with extremely long maintenance intervals.

Applications for TEXParts spindle bearing units

Spindle bearing types:

- **CS1**

Used in light cotton and worsted spindles with tube lengths of up to 260 mm and speeds of up to 22.000 rpm.

- **CS1 12**

Used in cotton and worsted spindles for the manufacture of coarse yarns (e.g. denim yarns) as well as for spinning with suppressed yarn balloon and for spinning with big tube sizes up to 280 mm length.

- **HF 3**

Used in light cotton and worsted spindles with large cop size, and in medium-sized twisting spindles, for tube lengths of up to 340 mm and speeds of up to 15.000 rpm.

- **HF 44, HZ 440, HZ 55, HZ 66, HZ 68, HZ 77**

Used in spinning and twisting spindles exposed to high stresses, corresponding to the following guideline values:

Axial loads	up to 3.5 daN,	tube lengths up to 360 mm	for HF 44, HZ 440
Axial loads	up to 5 daN,	tube lengths up to 450 mm	for HZ 55
Axial loads	up to 7 daN,	tube lengths up to 500 mm	for HZ 66
Axial loads	up to 13 daN,	tube lengths up to 500 mm	for HZ 68
Axial loads	up to 13 daN,	tube lengths up to 600 mm	for HZ 77

- **BI-FLEX SMM-32/42**

Used for high-speed applications, such as for draw twisting machines (load data on request).

The applications given above are rough guideline values. When selecting the right spindle bearing model, the TEXParts technical specifications must be taken as the basis.

Tubes and bobbins

Tubes and bobbins

The service-life of spinning and twisting spindles is mainly affected by unbalances of the rotating spindle elements (upper part and tube) or of the bobbin yarn package. Major unbalances cause high reaction forces in the spindle bearings. These forces increase disproportionately with raised spindle speed with unexpected wear of the bearings and spindle failure in particular unfavourable conditions.

Such major unbalances, moreover, lead to spindle vibrations with detrimental effects on yarn quality and ends down rates, thus raising energy consumption and noise emission.

Today spindle upper parts generally are produced at best quality, i.e. with extremely low out-of-true properties and suitable resistance to deformation whereas in many cases only less attention is given to the quality of tubes and bobbins. So for example tubes often show too much clearance or inaccuracies in shape or they are made of poor material respectively.

For these reasons and because of the applied top speed ranges high tube quality is a basic requirement. The following aspects should be taken into account here:

• Tube clearance

The clearance between tube and spindle upper part has to be kept as small as possible.

It, however, has to be reminded to the fact that the tube can easily be fitted and removed again and that contraction through yarn winding does not cause the tube to stick to the upper spindle part.

The following technical measures have proved to be successful:

- reduction of the tube/bobbin tolerances by improved manufacturing methods and use of high-quality materials.
- partial recesses in the upper part or in the tube/bobbin to provide more tolerance against deformation and contraction.
- use of dimensionally stable materials or metal fittings to avoid changes in tube diameter resulting from continued tube handling.

• Tube curvature and wall thickness differences

It's a fact that tubes/bobbins with curvatures or large differences in wall thickness increase unbalance. Here, too, the attempt should be made to reduce the tolerances by means of high-quality manufacturing as well as the use of high-quality materials. A suitable tolerance recommendation for tapered tubes has been adopted in ISO 368 standard.

Chapter 9-6

• Tube stiffness

Especially in the high-speed range tubes can be bent by dynamic forces connected with an increase in unbalances acting on the spindles. This is mainly true when the tube is supported over its full length by the upper part, or if the tube projects above the spindle blade at its upper end.

For this case it is strongly recommended to use dimensionally stable tubes made of high-strength materials.

• Wear on tubes and bobbin seats

At yarn breakage very often the spindle upper parts are not stopped by brakes but rather manually. The coupling buttons run into the tube material: the tubes run inadequately and the remaining inner contour of the tube and the spindle blade are then subject to wear. As it is generally well known this makes the replacement of the tube and of the whole spindle respectively necessary within a short time.

This problem can be minimised by using low-wear materials for tubes and bobbins or embedding low-wear rings; it, however, is best to correctly use the brakes. For tubes and bobbins it is advised to use ring inserts resistant to wear driven by friction cones as this is the case with the so-called bare-blade spindles.

The reflections about tube quality presented above have been kept quite general. They are, however, suitable to demonstrate the importance of tube/bobbin quality and interrelated factors.

Practical ideas which generally have to make allowance to commercial considerations, too, must be matched to the respective application. Corresponding proposals are made by machine manufacturers and authorised spindle producers.

The functions of ring and traveller¹⁾

Ring and traveller are the main elements during ring spinning and twisting. They determine to a large extent the performance and the operating conditions of the machine. The ring traveller accomplishes two main tasks while running on the ring at high speeds: 1. it provides the fibre band or the double thread supplied by the feed rollers with the necessary torsion

2. it assists in winding the yarn onto the bobbin in the form of a cop with the "correct" tension.

During this operation the ring guides the traveller which is essential for the perfect positioning of the yarn and the formation of the cop.

The traveller is pressed against the ring track by centrifugal forces. The resulting frictional forces reduce the speed of the traveller, which is dragged along by the passing-through yarn, and provide the yarn with the tensile forces necessary for assembling the individual fibres into the spun yarn as well as for limiting the yarn balloon.

Steel travellers are hardened to a certain degree and polished to a mirror finish. They can be adapted in shape, weight and surface finish to the ring, the yarn type and the yarn count.

Nylon travellers of the standard quality (for HZ and J rings) are made of highly wear-resistant polyamide. Extremely aggressive yarns are processed with glass-fibre reinforced Super-Nylon travellers or Nylon-Steel travellers with steel insert.

The operations of twisting and winding carried out by the traveller must be performed without undue tension of the yarn. The ratio of the spindle speed to the speed at which the yarn is supplied determines the torsion of the yarn. Any variation in this ratio is easily compensated for by the traveller without influence on its twisting, winding and tensioning operations.

On **flange rings**, the sliding speed of suitable high-performance traveller shapes may be as high as 40 m/s (144 km/h), on CERA-DUR coated rings even 45 m/s (162 km/h).

Taking as basis a 3-shift-operation, i.e. 24 hours a day, a traveller running at 40 m/s covers a day trip of 3500 km or 35000 km in 10 days. This is in fact a fantastic job, if you consider that rings and travellers are two metal parts functioning just with the help of fibre lubrication. Prerequisites are, however, perfectly adopted rings and travellers as far as matching shapes and traveller cross sections are concerned and also an optimum material choice of the friction partners rings and travellers for making sure that the film of lubricating fibres will always be sufficient and that no yarn damage will occur.

On oil-lubricated conical **J rings**, steel travellers may reach speeds of up to 35 m/s (126 km/h).

On oil-lubricated vertical **HZ rings**, this value may even be surpassed by nylon travellers under favourable operating conditions.

The travellers operating at such high speeds do often sustain loads per surface unit of more than 35 N/mm². Even if high-quality materials are used and if hardness and wear resistance are the best ones imaginable, these values will only be attainable with a constant and ever sufficient, uniform supply of lubricant to the traveller contact area.

Prerequisites for Good Operating Results

The maximum ability of rings and travellers to withstand strain is the limit to the performance of ring spinning and twisting machines. Intensive research and the latest knowledge about the choice of material and surface finish for rings and travellers and their design paved the way for a considerable increase in their ability to withstand strain. It is known that the traveller wear does not only depend on the material chosen but that quite complicated problems of heat dissipation play a part. The heat that generates between ring and traveller must be dissipated so rapidly that a local temperature increase of the traveller wear zones is avoided.

The ability of the traveller to endure strain is influenced by quite a number of factors. Investigations regarding improvements of rings and travellers aimed at a further increase in performance should above all make sure that all other conditions that are not directly connected with rings and travellers but have nevertheless a great influence on the spinning process are unobjectionable. Therefore make sure that:

- the rings are perfectly centered with regard to the spindles;
- the yarn-guide eyelet is well centered with regard to the spindle;
- the balloon control rings are perfectly centered with regard to the spindles;
- the spindle bearing is in good condition excluding spindle vibrations;
- the ratio between bobbin diameter, bobbin length and spindle gauge with regard to the ring diameter is correct;
- balloon control rings exist, their diameter matching the ring;
- appropriate, correctly adjusted traveller cleaners keep the flange traveller free from fibre fly;
- the room climate (temperature and relative air humidity) is favourable for the yarn processed;
- the air in the mill is free from dust and fibre fly that influence the efficient performance of the traveller negatively.

At any rate is a smooth and well run-in ring track a prerequisite.

1. Concentricity of the ring, balloon control ring and yarn-guide eyelet with regard to the spindle

In order to achieve good yarn qualities and low end breakage rates an exactly concentric and horizontal adjustment of the ring, the balloon control ring and the yarn-guide eyelet with regard to the spindle is required. This prevents one-sided ring wear, in particular if high spindle speeds are run. Also the ring rails or ring holders should therefore be installed in absolutely horizontal position compared to the vertically set up spindles.

¹⁾ With kind permission of Messrs. Reiners + Fürst GmbH und Co. KG, Mönchengladbach. Chapter 9-8

2. Ratio of ring diameter, bobbin diameter and length and spindle gauge

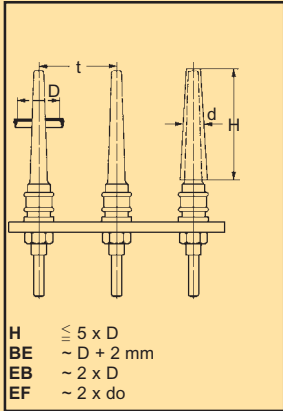

Symbols:

- t = spindle gauge
- D = inside ring \varnothing d_i
- d = mean bobbin \varnothing
- do = top bobbin \varnothing
- H = bobbin length
- BE = balloon control ring
- EB = setting distance ring/balloon control ring
- FB = yarn balloon
- RB = ring rail
- EF = setting distance top of bobbin/yarn-guide eyelet (measures in mm)

Recommended ratio values:

- D = t - 25 mm
- d:D in spinning:
0.48 - 0.5 or a 29° - 30°
(not less than 0.42 or a 26°)
- d:D in twisting:
0.44 - 0.5 or a 27° - 30°
(not less than 0.38 or a 22°)

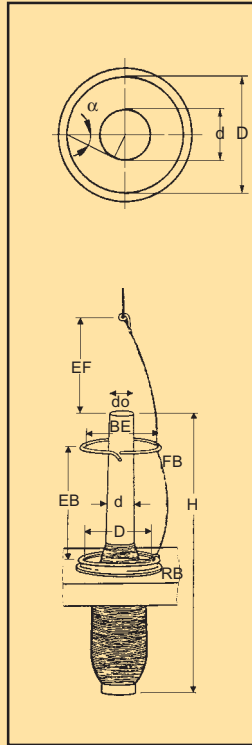

- d:D** : If the value **d:D** is **too small**, a high traveller strain occurs. Traveller wear and end breakages will increase.
If the value **d:D** is **too large**, it will result in disturbances of the yarn balloon. The balloon may collapse temporarily, resulting in increased hairiness and end breakages.
- H** : If a too long bobbin or spindle is chosen (e.g. $H = 5.5 \times D$), the yarn balloon will contact the tip of the bobbin. Besides increased end breakages a worse yarn quality will be registered.
- D and t** : When choosing the ring \varnothing (D) the spindle gauge (t) has to be taken into consideration.

Ring \varnothing (D) up to 85 mm

The ring diameter can be **25 mm** smaller at a maximum with regard to the spindle gauge.

Ring \varnothing (D) from 90 mm

The ring diameter can be chosen **30 mm** smaller at a maximum with regard to the spindle gauge.

Only then traveller and yarn balloon will have the necessary freedom of movement. Inserting the traveller, repairing end breakages and exchanging the cop can in this case be done with fewer obstacles.

- BE** : The balloon control ring should be 2 - 3 mm larger than the ring diameter. If the balloon control ring is too big, it will not fulfil its job of releasing the yarn balloon.

3. Balloon control rings, separators, yarn-guide eyelets

The influence of balloon control rings is quite considerable, especially if long cops are involved. A reduction of the yarn balloon is advantageous or may even be the prerequisite for highest spindle speeds in order to reduce the traveller strain. Balloon control rings should be in concentric position and without damage. If balloon control rings are mounted in the correct distance of height, (the balloon should be restricted as long as possible during one lift of the ring rail), a marked performance increase can be achieved.

If very delicate fibre materials are processed (e.g. certain synthetic fibres or core yarns) which require the balloon control rings to be removed, separators are required.

Sufficiently long separators, which are generally installed additionally besides balloon control rings, help to avoid series of yarn breaks. Furthermore they prevent to a great extent fibre fly from depositing on neighbouring spindles, especially in the case of end breakages.

Yarn-guide eyelets should be wear-resistant and have the optimum diameter. They have to be mounted with the correct distance in height in order to guarantee the proper transmission of the yarn twist. Damaged yarn-guide eyelets have to be replaced in time.

4. Traveller cleaners

Traveller cleaners are an excellent means to remove all fibre fly that deposits on the outer part of travellers on **flange rings**. The traveller cleaner should have the right distance to the outside ring flange. If it is not perfectly adjusted, fibre fly will deposit at the outer traveller bow. This results in an increased traveller weight and air resistance so that yarn tension and end breakages increase.

5. Room climate

A constant temperature and air humidity will have positive effects on the operation of the traveller. Variations in the atmospheric conditions within the room like higher air humidity will increase the friction wear and the lap formation through static charge. Besides the regular exchange of air the cleanliness of the air is of great importance for the traveller. Any dust (also dust coming from unsuitable floors) or other impurities may impair the operation of the traveller and produce more ring and traveller wear.

The air humidity distributed by the air conditioning must be free from alkaline components, because these may deposit on the ring and then disturb the traveller operation.

6. Choice of the «correct» flange width and ring height

The best operating results are obtained when the ideal flange width is chosen for flange rings and the ideal ring height is obtained for self-lubricating HZ and J rings, dependent upon the yarn count range, the yarn quality and the traveller type.

7. Ring profile and traveller shape

Determining the most favourable ring and traveller shape as well as surface treatment is a prerequisite for obtaining the best possible individual performance. If ring profile and traveller shape match well, the traveller will adopt a stable position in

the ring. It should have sufficient freedom of movement, so that any obstacles, which may occur especially when the machine is started, are avoided. A sufficiently large yarn clearance prevents yarn breaks and yarn damage.

On flange rings the contact between ring and traveller should only be as shown in Fig. 4a. Any further contact between ring and traveller e.g. with its foot at the inner or outer ring web (Fig. 4b) would impede the operation of the traveller. The consequences are more yarn breaks and a higher ring and traveller wear.

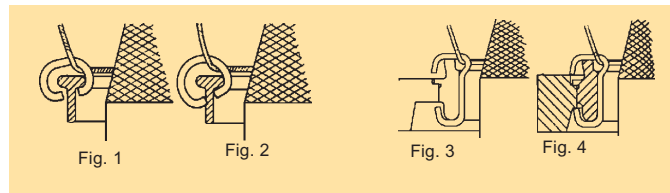

On HZ and J rings the contact should only be as illustrated in Fig. 5a. Any further contact of the traveller at the upper or lower ring rail or ring holder (Fig. 5b) would impede the operation of the traveller. The rings should have a perfect fit in the ring rail or ring holder. Incorrectly fastened rings may turn in the bore or be lifted out. The travellers will then strike against the bottom part of the ring rail or ring holder. In doing so, they may pinch off the lubricating wick and interrupt the flow of oil.

8. Correct surface smoothness, i.e. optimum peak-to-valley height and evenness of the ring track

The traveller contact surface must be smooth and even. Only then will a smooth operation of the traveller be possible. The contacted surfaces should be clean and preferably without traces of wear. In addition they should be designed in a way to offer a sufficient adherence for the lubricants coming into question (fibre or oil lubrication).

Once the sliding surfaces have lost their original quality, the best ring traveller will not be able to run smoothly. For maintaining the surface of the running track in a good condition it is very important - besides a certain degree of maintenance - to run the ring well in.

9. Steady formation of a lubricating film

Flange rings must not be lubricated with oil or grease. Instead, a continuous film of lubricating fibres should form on the running track.

HZ and J rings should be provided with a lubricating system, which suits the yarn count range, the yarn quality, the traveller style and the operating speed. The lubricant should be supplied to and given off from the ring continuously and in even amounts.

Rings of **steel** should have wicks and felts in good condition. Damaged or dirt-crusted wicks and felts prevent an even spreading of the lubricant on the ring track. They should therefore be replaced in time.

In the case of **sintered steel rings** the lubricating holes (pores), which are interconnected and go through the entire ring, should not be clogged at the sliding surfaces which give off oil.

If the rings are re-lubricated at regular intervals with a special oil of optimum viscosity, high speeds are possible and rings and travellers may obtain long service lives. Any change in lubrication will cause a variation of the frictional values and consequently of the yarn tension.

10. Running-In the rings

In many cases the running-in procedure is decisive for the future positive or negative behaviour of the ring and the length of its working time. Every ring requires a certain amount of running-in, if it is to maintain high traveller speeds with as little ring and traveller wear as possible. Running-in should therefore always be done by the recommendations specified for each ring type. During running-in the use of steel travellers without surface treatment is recommended. After the termination of the running-in process, steel travellers with surface treatment or nylon as well as bronze travellers can be used.

11. Traveller numbers and traveller wear

The traveller weight (number) should conform to the yarn thickness. Other important factors are spindle speed, delivery speed, balloon size and cop hardness. The influence of the balloon form on the operational behaviour and in particular on the rate of yarn breaks may be quite considerable. The yarn balloon should only have slight contact with the balloon control ring. A too loose or too taut yarn balloon (if the traveller is too light or too heavy) must be avoided. These balloon forms will bring about more yarn breaks, increased traveller wear and an inferior yarn quality.

The extent of traveller wear is fundamentally influenced by the quality of the fibres processed, the traveller speed and the ring condition. Heavy traveller wear will lead to increased ring straining, variations in winding and balloon tension and a smaller yarn clearance of the traveller. HZ and J travellers may change their operating position and strike against the ring holder, the ring rail and the fastening elements. Regular traveller changes made in time will contribute to an even yarn quality and a longer ring service life. Regular changing intervals are therefore recommended.

Attention!

The recommendations given above must be respected even more strictly for the ring spinning frames of the new generation, e.g. operating at spindle speeds of up to 20.000 rpm. Discrepancies in diameter coordination, centering, vibration-damping, traveller cleaner position etc, and especially in observing the ring/traveller recommendations, can result in significantly poorer running conditions and considerably increasing wear of ring and traveller.

Spindle drive in ring frames

The following types of drive system are commonly used for spindles in ring frames:

- **Four-spindle tape drive**
- **tangential belt drive**
- **sectional drive**

All these spindle drive types require either tapes or belts for power transmission from motor to spindle. With all of these drive systems, it is necessary to press the tape or belt with sufficient force against the spindle wharve. Deviations of the spindle out of its central position in relation to the spinning ring should be avoided here. The spindles must on the one hand reliably achieve the required spindle speed with as little slip as possible, not displaying any notable speed differences between the spinning points of a machine; and on the other hand, there is the technological requirement to accelerate the spindles up to their rated speed in the shortest possible time after repairing yarn breaks.

TEXParts supplies contact pressure assemblies of the finest design and quality, as are needed for all tape and belt drive types.

Tangential and sectional drive

Tension pulleys SR (see chapter 2 page 10)

SR 28 tension pulleys with flanges arranged at top or bottom are used in the tangential belt drive with 2 independent tangential belts for the left-hand and right-hand ring frame sides respectively for guiding the belt return movement.

Contact roll assemblies AR

There are a number of different standard series available depending on application:

- AR 5047 with 50 mm shell diameter for belts up to 40 mm width
- AR 5024 with 50 mm shell diameter for belts up to 16 mm width
- AR 3528 with 35 mm shell diameter for belts up to 20 mm width

The contact roll assembly AR 5047 is used in ring frames with single-belt or double-belt tangential drive. Its design allows universal interchangeability with the previous standard variants AR 28, AR 45, AR 13/15. The shell diameter of 50 mm permits lower AR speeds, which in turn has a positive effect on service life, noise emission, re-lubrication intervals and the necessary energy requirement. For dependable belt guidance, the AR 5047 is fitted with two flanges.

The contact roll assembly AR 5024 is used in ring frames with sectional drive. It is also universally interchangeable with the previous AR 50-1246 555. For ring frames with sectional drive, there are also versions available with only one pulley (arranged left or right of holding angle). See chapter 2, page 6.

The contact roll assembly AR 3528 is used in ring frames with multi-motor single tangential belt drives.

All AR variants comprise two contact roll pulleys mounted on a spring bracket in the holding angle of the spindle rail. The defined sag of the leaf spring of the spring bracket determines the contact pressure of the contact roll pulleys against the belt. The pulley spacing is double that of the spindles.

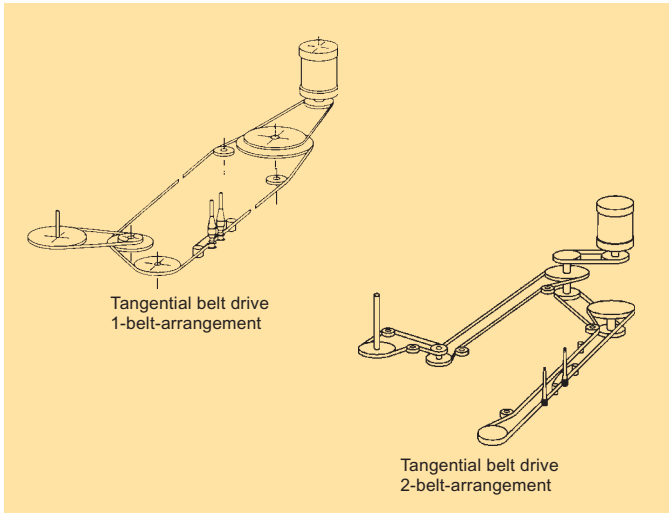
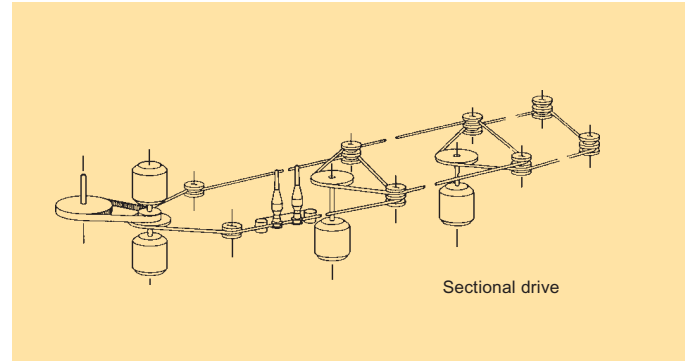

Series PK 3000 weighting arms for cotton ring frames pneumatic load principle

The weighting arms of the PK 3000 series with pneumatic loading of top rollers are designed for use in 3-roller double apron draft arrangements for spinning cotton, man-made fibres or blends thereof. Various sizes of top apron cradles (OH) are available to suit the different categories of fibre length. The size of the cradle used determines the front zone setting.

The different types of top apron cradles OH, draft field settings and maximum fibre length will be found in chapter 5, page 2-5.

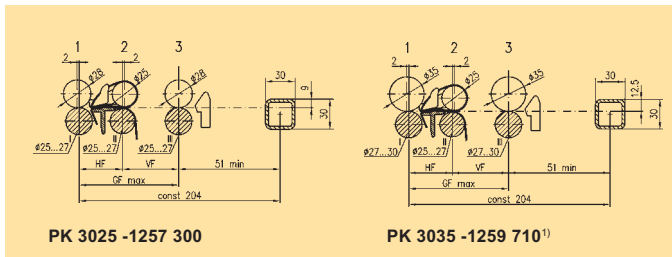

Fig. A: Draft arrangements for PK 3000 series

Draft sizes

Total draft

The amount of total draft to be applied mainly depends on the type and composition of the fibre material and quality of the roving. With weighting arm PK 3000 the normal total draft range for speed frame roving is, in practice, as much as 50 (see fig. B, Total drafts).

The choice of draft range depends on the desired yarn qualities and operating conditions of the frame (ends down behaviour) In-house spinning trials should be carried out to determine the optimum draft range. Fig. B (Total drafts) shows common draft ranges determined according to the respective fibre materials.

Rear draft

The purpose of rear zone draft is to slightly tension the roving and feed the fibre material to the main draft zone in a well-stretched condition. The usual rear draft for PK 3000 equipment ranges between 1.15 and 1.3.

¹⁾ In the case of PK 3035 the middle guide element is 3.5 mm longer than on the PK 3025 (middle guide element Ref. No. 1259 709)

Draft ranges for PK 3000

Rear drafts	Total drafts	
1.15 - 1.3	12-20	Extremely short carded cotton Carded cotton Combed cotton Blends of cotton and man-made fibres Pure man-made fibres
	20-35	
	20-40	
	25-45	
	25-50	

Fig B: Total drafts

When determining the optimum rear zone draft care should be taken for controlled draft of the roving in the rear zone. Hard-twisted roving needs a higher rear zone draft whereas a too strong loosening effect on the roving indicates the necessity for reducing the rear draft. Values of the rear zone settings depends on the fibre to be spun, fibre length and roving twist.

A total draft zone width expanded by 82 mm to 155 mm in comparison to PK 2000 series permits additional and previously unfeasible draft system variants.

Draft fields

Front zone setting

The front zone setting depends on the type of top apron cradle. In tab. A, page 9-20 (Draft field settings), the distance HF (front zone = centre of bottom apron roller/front bottom roller) is shown for the respective bottom roller diameters (I, II).

Differences between bottom roller diameters and the values given in the table must be taken into consideration when the front zone is determined.

The fronthang of the front top roller 1 in relation to the front bottom roller is 2 mm (System dimension: support rod/ front bottom roller = 204 mm). Apron top roller 2 has a backhang by 2 mm in relation to the axis of the bottom roller II (fig. C). Basically, when adjusting the front zone setting you should make sure that the operation of the individual draft elements doesn't get impaired (e.g. when front zone condensers are used).

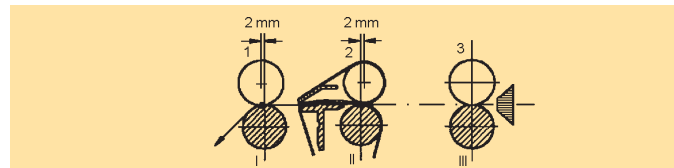
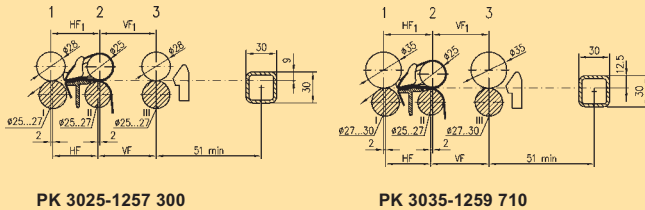

Fig. C: Fronthang of front top roller and backhang of middle top roller

Weighting arms, zone settings and maximum fibre length

Weighting arm	Top apron cradle	Bottom roller diameter			Draft field mm			Total draft field GF mm max.	Fibre length max. mm
		I	II	III	HF	VF min	VF usual ¹⁾		
PK 3025-1257 300	OH 2022	25/27	25/27	25/27	44	41	1)	153	45
	OH 2042				53	41	1)	153	54
	OH 1225				68	41	1)	153	60
PK 3035-1259 710	OH 2022	27/30	25/27	27/30	46	41	1)	153	45
	OH 2042				55	41	1)	153	54
	OH 1225				70	41	1)	153	60

Table A: Summary of different weighting arm types for cotton draft systems



PK 3025-1257 300

PK 3035-1259 710

Fig. D: Zone settings for PK3000 series weighting arms

¹⁾ Depends on the fibre to be spun, fibre length and roving twist.

Rear zone setting

The rear zone setting depends on the type of fibre to be spun, fibre length and roving twist. Rear zone settings larger than those in the Table A should be selected if the material to be processed is difficult to be drafted. This may be the case with hard-twisted roving or man-made fibres with strong inter-fibre bonding. In-house trials should be carried out to find out the optimum rear zone setting.

Roller loading

Types, Ref. No.

PK 3025-1257 300 PK 3035-1259 710

Load on top roller [daN]

Front 1

11,5

20,5

25

Middle 2

10

16

19,5

Rear 3

11,5

20,5

25

Operating pressure [bar]

1,5 bar

3,0 bar

4,0 bar

standard application range

extended application range*

Pneumatic Unit

1.5 to

3.0 bar
(4.0 bar)

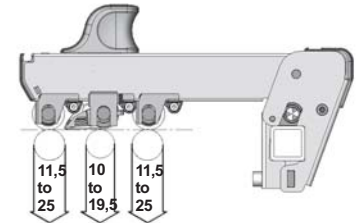

Fig. E: Roller loading PK 3000 series

The weighting pressure in the PK 3000 is generated pneumatically by a closed-circuit compressed air system (fig. F).

The air supply to the draft system in the PK 3000 is completely integrated into the support rod.

The weighting pressure onto the top rollers can be set infinitely and centrally through the air pressure and thus, an optimum adjustment to the fibre material is possible. Due to the pneumatic spring in the weighting arm the operating pressure is being transformed into the saddle load directly via the pressure plates of the individual weighting elements.

Pressure setting and system monitoring are performed centrally at the pneumatic unit installed in the headstock of the ring frame.

*) The possibility to utilize the "extended application range" has to be discussed with OEM.

The roller load on rear, apron and front top rollers (see fig. E) are interlinked at a fixed ratio. This ratio is determined by the pressure plate size of the weighting elements. When the working pressure is changed, this ratio remains constant. The correlation between the set working pressure and the saddle load of all top rollers in the weighting arm is shown as a graph in fig. G. In most applications (e.g. if cotton fibres are processed), a working pressure between 1.7 to 2.0 is sufficient to reach good spinning conditions. In the case of man-made fibre materials or blends, a working pressure between 2.2 to 2.5 bar can be of advantage.

There is no risk of incorrect setting of the individual weighting arm because of the centralised and simple pressure setting.

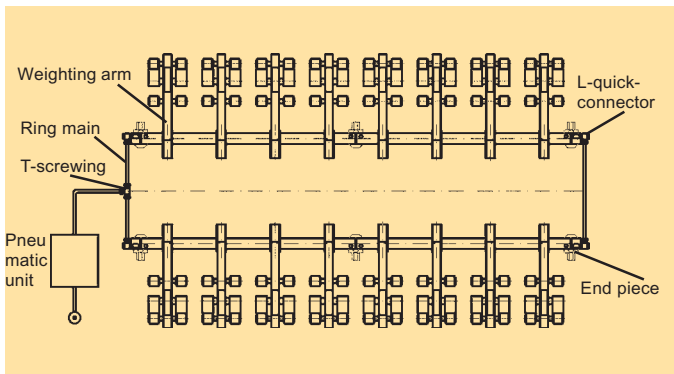
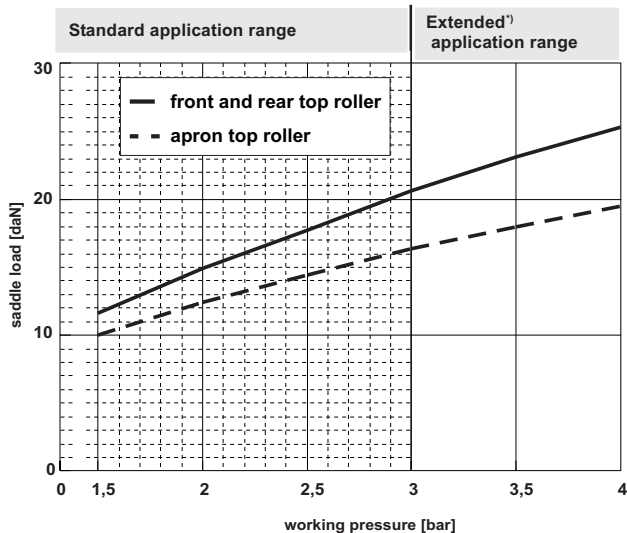

Fig. F: Air supply system for PK 3000 series

Partial load relieve

The weighting arms PK 3000 offers the possibility of practical and reliable central partial load relieve in order to prevent moiré effect. This is applied to the top rollers thanks to the inherent elasticity of the pneumatic spring. It automatically takes effect after a certain period of time when the ring frame is turned off by the main switch.

The partial load prevents intrusion of the yarn twist into the draft field, and even soft top roller cots are protected from permanent deformation (no moiré effect!). After the switch off of the ring frame, the partial load relieve develops automatically.



*) The possibility to utilize the "extended application range" has to be discussed with OEM.

Fig. G: Correlation between saddle load and working pressure for PK 3000 series

Top apron cradles and top aprons

Depending on the application, the weighting arms of PK 3000 Series can be fitted with different top apron cradles:

- Short staple top apron cradles OH 2022**
for cotton and man-made fibres up to 45 mm length, and for blends thereof
- Medium staple top apron cradles OH 2042**
for cotton fibres over 40 mm length, man-made fibres and blends thereof up to cut lengths of 54 mm.
- Long staple top apron cradles OH 1225**
for man-made fibres of cut lengths up to approx. 60 mm.

The top apron cradles OH 2022/OH 2042 offer the following advantages:

- aprons can be exchanged without the apron unit being dismantled, i.e. with the OH aggregate still in place.
- individual apron tensioning by means of movable apron guide places, less strain on the fibres and gentle guidance during the draft process.
- low-friction apron running ensures low drive torques and long apron working time.

The following table shows the top apron cradles for TEXParts weighting arms PK 3000 together with the associated top aprons, the apron inner diameter and the recommended standard range of distance clips.

Top apron cradles, top aprons and distance clips for PK 3000-series:

Top apron cradles OH Ref. No.	Gauge Tw [mm]	Top aprons general designation	Basic equipment Distance clips ¹⁾ Ref. No.	Colour
OH 2022-1247 888	68.4	PR 28	↑ OLC-0964 118 OLC-0017 705 OLC-0964 119 ↓	yellow
OH 2022-1247 887	75	PR 28		lilac
OH 2022-1247 889	82.5	PR 28		white
OH 2042-1250 133	68.4	PR 2813	↑ OLC-0964 117 OLC-0964 118 OLC-0964 119 ↓	red
OH 2042-1250 134	75	PR 2813		yellow white
OH 1225-6001 674 ²⁾	68.4	PR 028	↑ OLC-0964 118 OLC-0964 119 OLC-0017 627 ↓	yellow
OH 1225-6001 257 ²⁾	75	PR 032		white
OH 1225-6001 675 ²⁾	82.5	PR 032		grey

Fig. H: Range of top apron cradles, top aprons and distance clips for PK 3000 weighting arms

¹⁾ One clip per cradle is required for each type of OH. Clips are not included in standard OH supply and have to be ordered separately.

²⁾ Available on request.

Opening X at apron release point

The vertical distance between the front edge of the top apron cradle, the type of aprons (top and bottom) and the bottom apron nose bar determine the intensity with which the fibre material is controlled and guided between top and bottom aprons (fig. I). To achieve optimum draft conditions, the opening X can be adjusted using distance clips. Figs. J/K show which distance clips are to be used to provide the respective opening X for the various top apron cradles. As a basic rule of thumb: the smaller the opening, the more even the yarn.

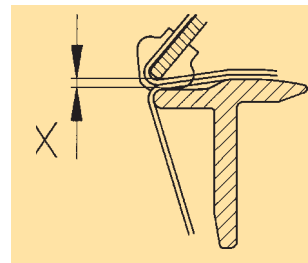

Fig. I: Opening X

The selection of the opening X also depends on the following parameters:

- type of fibre material
- fibre mass in the main draft zone
- roving and yarn count
- type of top apron cradle
- type of apron and dimensions
- type of bottom apron nose bar and its position.

Taking all these parameters into account, the selection of the opening X represents the best compromise. Extremely narrow openings result in good yarn qualities, though frame operating conditions (ends down, undrafted portions etc.) may, under certain circumstances, negatively be influenced. The ideal opening for the fibre material to be processed thus should be determined by mill trials.

Distance clip OLC		Top apron cradle OH		
Colour	Ref. No.	OH 2022 (short)	OH 2042 (middle)	OH 1225 (long)
red	0964 117	-	2.4	2.6
yellow	0964 118	2.2	2.8	3.4
lilac	0017 705	2.5	3.2	3.4
white	0964 119	2.8	3.5	3.7
grey	0017 627	3.3	4.0	4.2
black	0964 120	3.8	4.6	4.7
beige	0004 587	4.8	6.0	5.7
green	0004 588	5.5	6.6	6.2

Fig. J: OLC Distance clips in combination with TEXParts top apron cradles (The figures in the column give the values for the opening X in mm.)

The following information (see fig. K) is intended as a guide for the choice of distance clips for various yarn counts.

OLC No		red 0964 117	yellow 0964 118	lilac 0017 705	white 0964 119	gray 0017 627	black 0964 120
OH 2022 opening "X" in mm			2,2*	2,5*	2,8*	3,3	3,8
Ne	Nm						
6	10						
10	17						
20	34						
30	51						
40	68						
>40	>68						

OLC No.		red 0964 117	yellow 0964 118	lilac 0017 705	white 0964 119	grey 0017 627	black 0964 120
OH 2042 opening "X" in mm		2,4*	2,8*	3,2	3,5*	4,0	4,6
Ne	Nm						
6	10						
10	17						
20	34						
30	51						
40	68						
>40	>68						

* Basic equipment of distance clips. Clips are not included in OH supply.

OLC No		red 0964 117	yellow 0964 118	lilac 0017 705	white 0964 119	gray 0017 627	black 0964 120
OH 1225 Opening "X" in mm		2,6*	3,4*	3,4	3,7*	4,2	4,7
Ne	Nm						
6	10						
10	17						
20	34						
30	51						
40	68						
>40	>68						

* Basic equipment of distance clips. Clips are not included in OH supply.

Fig. K: Choice of distance clips in combination with TEXParts top apron cradles

Top roller cots

Top rollers for PK 3000 weighting arms are supplied as top rollers without cots as standard. If desired, TEXParts will also supply top rollers with ready-ground cots. The cot quality can be determined by the customer.

Subsequent grinding of the cots may reduce the cot diameter of rear and front top rollers by a maximum of 3 mm. Within this range it is not necessary to readjust the height of the weighting arm or increase the loading via increasing the air pressure.

Regarding cot quality, rear and front top rollers are mutually interchangeable.

The choice of cot mainly depends on the type of fibre material to be processed and its running properties.

Cots having a Shore hardness between 63 and 83° are used for rear and front top rollers today. In the case of soft cots, it is advisable to apply the partial load relieve on all top rollers, if the frame is idle for longer periods. This will prevent moiré effects caused by fluting.

TEXParts supplies the apron top roller LP 1003 with plastic sleeves as standard. If requested, the apron top roller LP 1002 with cots can also be supplied. Cots with a Shore hardness between 75 and 80° are suitable for this apron top roller.

Bottom aprons

The dimensions of the bottom aprons depend on the design of the substructure of the draft system. Two types of substructure are most common in practice:

1. Long bottom apron system

Bottom aprons are guided and prestressed by a tensioning link.

2. Short bottom apron system

Bottom aprons are guided by specially designed bottom apron nose bars.

Series PK 2000 weighting arms for cotton ring frames

Various types of weighting arms are available for cotton ring frame draft. The arms of the PK 2000-series are designed for use in 3-roller double apron draft arrangements for spinning cotton, man-made fibres and blends thereof. Various sizes of top apron cradle OH are available to suit the different categories of fibre length. The size of the respective cradle used determines the front zone setting. The different types of top apron cradles OH, draft field settings and maximum fibre length will be found in chapter 5, page 6-13.

Weighting arm PK 2000 series Ref. No.

PK 2025-1251 331
PK 2035-1251 784
PK 2055-1251 785
PK 2065-1251 786

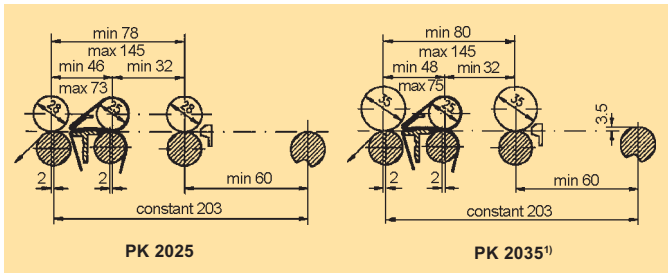

Fig. A: Draft arrangements PK 2025 and PK 2035

Types PK 2035 and PK 2065 weighting arms are mainly used for spinning longer staple fibres. They are designed for this purpose for use with rear and front top rollers with a diameter of 35 mm. For spinning particularly fine yarns, materials that are difficult to draft and for spinning with high total drafts, we recommend the weighting arms PK 2055 and PK 2065.

¹⁾ In the case of PK 2035 the middle guide element is 3.5 mm longer than on the PK 2025.

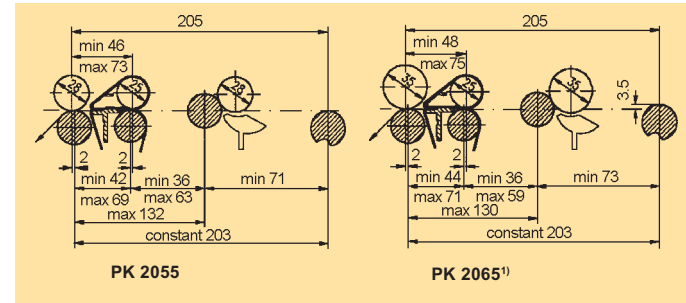

Fig. B: Draft arrangements PK 2055 and PK 2065

Draft sizes

Total draft

The amount of total draft to be applied mainly depends on the type and composition of the fibre material and the quality of the roving. With weighting arms, types PK 2025 and PK 2035, the normal total draft range for speed-frame roving is, in practice, as much as 50 (see fig. C, Total drafts on the following page). The choice of draft range depends on the desired yarn qualities and the operating conditions of the frame (ends down behaviour) In-house spinning trials should be carried out to determine the optimum draft range. Fig. C (Total drafts) shows common draft ranges arranged according to different fibre materials.

Rear draft

The purpose of rear zone draft is to slightly tension the roving and to feed fibre material to the main draft zone in a well-stretched state. The usual rear draft for PK 2025 and PK 2035 equipment ranges between 1.15 and 1.3. In special cases, rear drafts greater than 1.3 are possible with PK 2055 and PK 2065.

¹⁾ In the case of PK 2065 the middle guide element is 3.5 mm longer than on the PK 2055.

Draft ranges for PK 2025 and PK 2035

Rear drafts	Total drafts	
1.15 - 1.3	12-20	Extremely short carded cotton Carded cotton Combed cotton Blends of cotton and man-made fibres Pure man-made fibres
	20-35	
	20-40	
	25-45	
	25-50	

Draft ranges for PK 2055 and PK 2065

Rear drafts	Total drafts	
1.15 - 1.3	up to 50	Cotton Man-made fibres Blends
1.3 - 1.6	50-70	
1.6 - 1.8	over 70	

Fig. C: Total drafts

In determining the optimum rear zone draft care should be taken for a controlled draft of the roving in the rear zone. A hard-twisted roving needs a higher rear zone draft whereas a too strong loosening effect on the roving indicates the necessity for reducing the rear draft. Standard values for the rear zone settings are given in table A (Summary of different weighting arm types).

Draft fields

Front zone setting

The front zone setting depends on the type of top apron cradle (see table A). The figures shown for front zone setting HF (front zone = centre of the bottom apron roller/front bottom roller) are based on the use of the diameters shown for these rollers in fig E, page 9-32. Differences between bottom roller diameters and the values given in table A must be taken into consideration when the front zone is determined. The fronthang of the front top roller I in relation to the front bottom roller is 2 mm. (System dimension: support rod/front bottom roller $d = 203$ mm). Apron top roller 2 has a backhang of 2 mm in relation to the axis of the bottom roller II (see fig. D). Basically, when adjusting the front zone setting, you should make sure that the operation of the individual draft elements doesn't get impaired (e.g. when front zone condensers are employed).

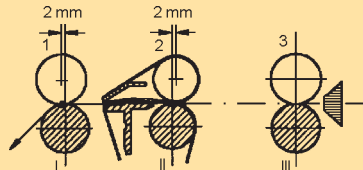

Fig. D: Fronthang of front top roller and backhang of middle top roller

Chapter 9-30

Weighting arms, zone settings and maximum fibre length

Weighting arm	Top apron cradle	Bottom roller diameter			Draft field mm*			Total draft field GF mm max.	Fibre length max. mm
		I	II	III	HF	VF min	VF usual ¹⁾		
		PK 2025-1251 331	OH 62	25/27	25/27	25/27	44		
OH 2022	44	45							
OH 132	53	54							
OH 2042	53	54							
OH 122	68	60							
PK 2035-1251 784	OH 62	27/30	25/27	27/30	46	34	1)	143	45
OH 2022	46				45				
OH 132	55				54				
OH 2042	55				54				
OH 122	70				60				
PK 2055-1251 785	OH 62	25/27	25/27	25/27	44	36	1)	132	45
OH 2022	44				45				
OH 132	53				54				
OH 2042	53				54				
OH 122	68				60				
PK 2065-1251 786	OH 62	27/30	25/27	27/30	46	36	1)	130	45
OH 2022	46				45				
OH 132	55				54				
OH 2042	55				54				
OH 122	70				60				

Table A: Summary of the different weighting arm types for cotton draft systems * see figure E.

¹⁾ Depends on the fibre to be spun, fibre length and roving twist.

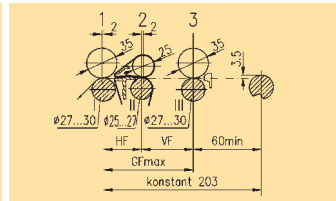
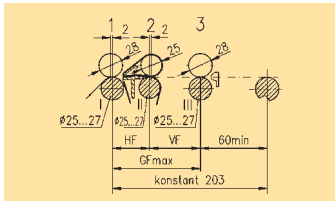

PK 2025

PK 2035

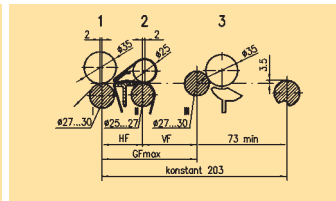
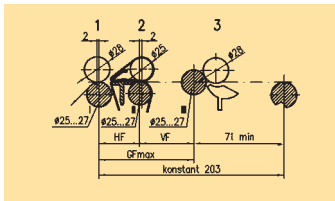

PK 2055

PK 2065

Fig. E: Zone settings for PK 2000 series weighting arms

Rear zone setting

The rear zone setting depends on the type of fibre to be spun, length of fibre, and roving twist. Rear zone settings greater than those in the table should be selected if the material to be processed is difficult to be drafted. This may be the case with hard-twisted rovings or man-made fibres with strong fibres / fibre bonding. In-house trials should be carried out to determine the optimum rear zone setting.

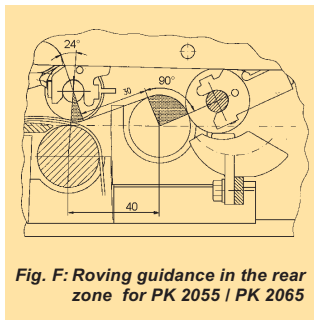

Fig. F: Roving guidance in the rear zone for PK 2055 | PK 2065

Roller loading

In the case of PK 2000 weighting arms 4 different loads can be set for the front top roller using the eccentric load selector on the front guide arm. The setting load is indicated by the respective colour marking on the eccentric load selector.

The loads on the middle and rear top rollers for the individual PK 2000 weighting arms are given in fig. G (Weighting arms PK 2000 and their roller loads).

To achieve good yarn quality, it is advisable to use the 2nd load stage (green-14 daN) for the front top roller when processing cotton and blends thereof. Pure man-made fibres, hard-twisted rovings, and fine yarn counts may require the 3rd load stage (red - 18 daN). Here the load on the middle and rear element of PK 2025/PK 2035 weighting arms can, if necessary, be raised up to 14 daN (middle) and 16 daN (rear) and the load on the middle element of PK 2055/PK 2065 to 14 daN.

If the OH 2042 (OH medium) is to process relatively long fibres or to spin fine yarn counts, the high load (14 daN) should be used at the apron top roller. If the ring frame hasn't been used for longer time and soft front top rollers are used, the load on the front element of PK 2000 weighting arms can be set to the load stage (white - 6 daN) (partial load relieve) in order to prevent moiré effects.

Weighting arm Ref. No.	Front top roller [daN]	Apron top roller [daN]	Rear top roller [daN]
PK 2000 Series			
PK 2025-1251 331	(6) ¹⁾ -10-14-18	10-14	12-16
PK 2035-1251 784	(6) ¹⁾ -10-14-18	10-14	12-16
PK 2055-1251 785	(6) ¹⁾ -10-14-18	10-14	18
PK 2065-1251 786	(6) ¹⁾ -10-14-18	10-14	18

Fig.G: Weighting arms PK 2000 and their roller loads.

Adjusting the load on the front element

The load on the front guide element can be adjusted in 4 stages. Adjustment is effected by means of an eccentric load selector activated by the setting wrench 0998 222. The load set can be identified by the code colour on the eccentric load selector visible in the opening on front guide arm.

The following load stages can be selected on the front element of PK 2000 series weighting arms:

Load setting	Colour code on load selector	Load [daN]
Partial load relieve	white	6
Basic load	black	10
Standard load	green	14
Maximum load	red	18

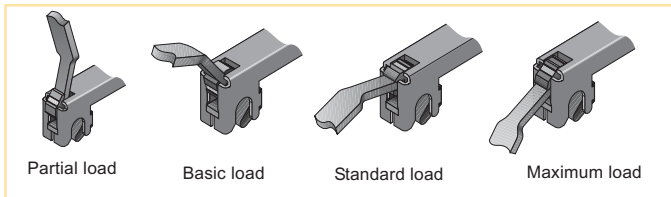

Fig. H: Load stages on front guide element of PK 2000 series weighting arms

Partial load relieve

PK 2000 weighting arms also allow partial load relieve on front guide element. This becomes possible by setting the eccentric load selector to colour code "white" using setting wrench 0998 222 (Fig. I: Partial load relieve). The partial load relieve has a saddle load of 6 daN.

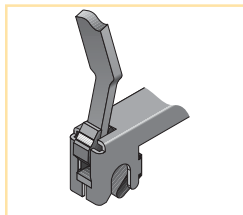

Fig. I: Partial load relieve at the front element of PK 2000-series weighting arms

Adjusting the load on the rear and middle element

Two different loads are possible for the middle and rear element of the weighting arms PK 2025, PK 2035 and for the middle element of the weighting arms PK 2055, PK 2065. The load on the rear and middle element is adjusted by turning the eccentric load selector by means of hexagon socket screwdriver 1249 383 (see fig. J).

The load set can be identified by the position of the eccentric load selector.

A) Basic load

The top edge of the eccentric load selector is in level with the upper edge of the element.

B) Maximum load

The top edge of the eccentric load selector is lowered by the dimension A=2.5 mm (see fig. K).

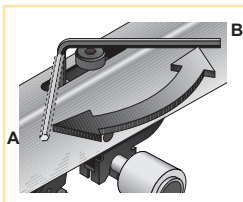

Fig. J: Load setting with the hexagon socket screwdriver

Weighting arms PK 2025/PK 2035

Load	Middle element [daN]	Rear element [daN]
Basic load	10	12
Maximum load	14	16

Weighting arms PK 2055/PK 2065

Load	Middle element [daN]	Rear element [daN]
Basic load	10	18
Maximum load	14	

Fig. K: Load setting on the rear and middle element of PK 2000

Top apron cradles and top aprons

Depending on the application, the weighting arms of PK 2000-series can be fitted with different top apron cradles:

- a) **Short top apron cradles OH 2022/OH 62**
for cotton and man-made fibres up to 45 mm length and blends thereof
- b) **Medium top apron cradles OH 2042/OH 132**
for cotton fibres over 40 mm length, man-made fibres and blends thereof up to cut lengths of 54 mm.

- c) **Long top apron cradles OH 122**
for man-made fibres of cut lengths up to approx. 60 mm.

The construction principle of the OH 62/OH 132/OH 122 cradles allows apron tolerances to be compensated with regard to apron guidance and stretching. Top apron cradles OH 2022/OH 2042 offer further additional advantages:

- aprons can be exchanged without the apron unit being dismantled, i.e. with the OH aggregate still in place.
- individual apron tensioning by means of movable apron guide places, less strain on the fibres and gentle guidance during the draft process.
- low-friction apron running ensures low drive torques and long apron service-time.

The following table shows the top apron cradles for TEXParts weighting arms PK 2000 together with the associated top aprons, the apron inner diameter and the recommended standard range of distance clips.

Top apron cradles, top aprons and distance clips for PK 2000

Top apron cradles OH Ref. No.	Gauge Tw [mm]	Top aprons general designation	Basic equipm. Dist. clips ¹⁾ Ref. No.	Colour
OH 2022-1247 888	68.4	PR 28	OLC-0964 118 OLC-0017 705 OLC-0964 119	yellow
OH 2022-1247 887	75	PR 28		lilac
OH 2022-1247 889	82.5	PR 28		white
OH 62-0962 841	90	PR 32		
OH 2042-1250 133 ²⁾	68.4	PR 2813	OLC-0964 117 OLC-0964 118 OLC-0964 119	red
OH 2042-1250 134 ²⁾	75	PR 2813		yellow
				white
OH 132-0963 671	82.5	PR 323		
OH 122-0963 495	68.4	PR 028	OLC-0964 118 OLC-0964 119 OLC-0017 627	yellow
OH 122-0963 500	75	PR 032		white
OH 122-0963 511	82.5	PR 032		grey

Fig. L: Range of top apron cradles, top aprons and distance clips for PK 2000 weighting arms

¹⁾ One clip per cradle is required for each type of OH. These clips are **not** included in standard OH supply and have to be ordered separately.

²⁾ For use in weighting arms of **PK 2000 series only** (high load setting (14 daN) at the middle element recommended).

Opening X at apron release point

The vertical distance between the front edges of the top apron cradle, the type of aprons and the bottom apron nose bar determine the intensity with which the fibre material is controlled and guided between top and bottom aprons (fig. M). To achieve optimum draft conditions, the opening X can be adjusted using distance clips. Figs. N/O show which distance clips are to be used to provide the respective opening X for the various top apron cradles. As a basic rule of thumb: the smaller the opening, the more even the yarn gets.

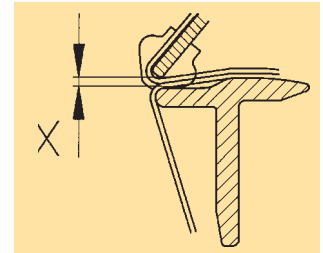

Fig. M: Opening X

Selection of the opening X also depends on the following parameters:

- type of fibre material
- fibre mass in the main draft zone
- roving and yarn count
- type of top apron cradle
- type of apron and dimensions
- type of bottom apron nose bar and build-in position.

Taking these parameters into account, the selection of the opening X represents something of a compromise. Extremely narrow openings produce good yarn qualities, though frame operating conditions (ends down, undrafted portions etc.) may, under certain circumstances, be negatively be influenced. The ideal opening for the fibre material to be processed in each case should thus be determined by mill trials.

Distance clip OLC Colour Ref. No.	Top apron cradle OH				
	OH 2022 (short)	OH 62 (short)	OH 2042 (middle)	OH 132 (middle)	OH 122 (long)
red 0964 117	-	-	2.4	2.5	2.6
yellow 0964 118	2.2	2.2	2.8	3.3	3.4
lilac 0017 705	2.5	2.5	3.2	3.3	3.4
white 0964 119	2.8	2.9	3.5	3.6	3.7
grey 0017 627	3.3	3.5	4.0	4.1	4.2
black 0964 120	3.8	3.9	4.6	4.6	4.7
beige 0004 587	4.8	5.2	6.0	5.7	5.7
green 0004 588	5.5	5.8	6.6	6.1	6.2

Fig. N: OLC Distance clips in combination with TEXParts top apron cradles
(The figures in the column give the values for the opening X in mm.)

The following information (see fig. O) is intended as a guide for the choice of distance clips to be used for various yarn counts.

OLC No		red 0964 117	yellow 0964 118	lilac 0017 705	white 0964 119	gray 0017 627	black 0964 120
OH 2022 opening "X" in mm			2,2*	2,5*	2,8*	3,3	3,8
Ne	Nm						
6	10						
10	17						
20	34						
30	51						
40	68						
>40	>68						

OLC No		red 0964 117	yellow 0964 118	lilac 0017 705	white 0964 119	gray 0017 627	black 0964 120
OH 62 opening "X" in mm			2,2*	2,5*	2,9*	3,5	3,9
Ne	Nm						
6	10						
10	17						
20	34						
30	51						
40	68						
>40	>68						

* Basic equipment of distance clips. Clips are not included in OH supply.

OLC No.		red 0964 117	yellow 0964 118	lilac 0017 705	white 0964 119	grey 0017 627	black 0964 120
OH 2042 opening "X" in mm		2,4*	2,8*	3,2	3,5*	4,0	4,6
Ne	Nm						
6	10						
10	17						
20	34						
30	51						
40	68						
>40	>68						

OLC No		red 0964 117	yellow 0964 118	lilac 0017 705	white 0964 119	gray 0017 627	black 0964 120
OH 132 opening "X" in mm		2,5*	3,3*	3,3	3,6*	4,1	4,6
Ne	Nm						
6	10						
10	17						
20	34						
30	51						
40	68						
>40	>68						

* Basic equipment of distance clips. Clips are not included in OH supply.

OLC No		red 0964 117	yellow 0964 118	lilac 0017 705	white 0964 119	gray 0017 627	black 0964 120
OH 122 opening "X" in mm		2,6*	3,4*	3,4	3,7*	4,2	4,7
Ne	Nm						
6	10						
10	17						
20	34						
30	51						
40	68						
>40	>68						

* Basic equipment of distance clips. Clips are not included in OH supply.

Fig. 0: Choice of distance clips in combination with TEXParts top apron cradles

Top roller cots

Top rollers for PK 2000 weighting arms are supplied as top rollers without cots as standard. If desired, TEXParts will also supply top rollers with ready-ground cots. The cot quality can be determined by the customer.

Subsequent grinding of the cots may reduce the cot diameter of rear and front top rollers by a maximum of 3 mm. Within this range it is not necessary to readjust the height of the weighting arm. With reference to the cot quality, rear and front top rollers are mutually interchangeable.

Determining the choice of cot mainly depends on the type of fibre material to be processed and its running properties.

Cots having a Shore hardness between 63° and 83° are used for rear and front top rollers today. In the case of soft cots, it is advisable to apply a low loading weight on the front top roller if the frame is idle for longer periods. This will prevent moiré-formation caused by fluting. The weighting arms of PK 2000-series are equipped with partial load relieve of the front element. The partial load relieve has a saddle load of 6 daN.

TEXParts supplies the apron top roller LP 1003 with plastic sleeves as standard for apron top roller. If requested, LP 1002 with cots can also be supplied as apron top roller. Cots with a Shore hardness between 75 and 80° are suitable for this apron top roller.

Bottom Aprons

The dimensions of the bottom aprons to be used depend on the design of the substructure of the draft system. In practice, two types of substructure are most common:

1. Long bottom apron system
Bottom aprons are guided and pre-tensioning by a tensioning link.
2. Short bottom apron system
Bottom aprons are guided by specially designed bottom apron nose bars.

Series PK 5000 weighting arms for cotton speed frames pneumatic load principle

Series **PK 5000** weighting arms are intended for 3-roller and 4-roller double-apron draft systems on cotton speed frames. They are suitable for spinning cotton, man-made fibres or blends thereof types up to approx. 60mm length.

The **PK 5000** weighting arm series comprises the types **PK 5025-1259 471** (28 mm Ø top rollers) and **PK 5035-1259 473** (35 mm Ø top rollers) for 4-roller double-apron draft systems and the types **PK 5025-1259 472** (28 mm Ø top rollers) and **PK 5035-1259 474** (35 mm Ø top rollers), which is designed for 4-roller double-apron draft equipment. The 4-roller version differs from the 3-roller version in having an additional condensing zone between the roller pairs I/1 and II/2 (see figs. A/B).

By deliberately condensing the fibre material in this zone, a reduction of the spinning delta is achieved, thus improving the incorporation of the fibres into the roving. This results in the following important advantages:

- reduced number of thread breakages (improved process reliability)
- increased efficiency
- greater package density at speed frame bobbin thanks to the more compact roving
- reduced fly generation.

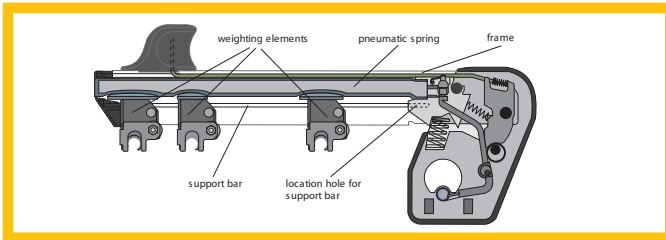

Fig. A: PK 5000-series for 3-roller draft systems

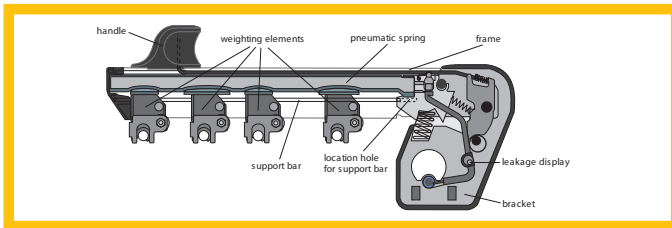

Fig. B: PK 5000-series for 4-roller draft systems

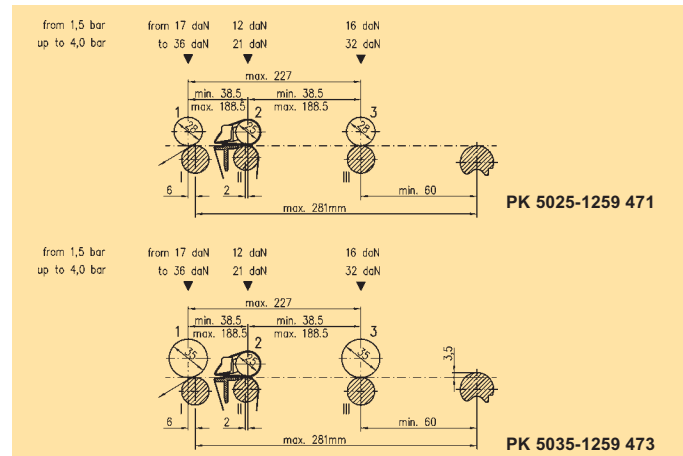

Fig. C: Draft arrangements PK 5000 for 3-roller versions

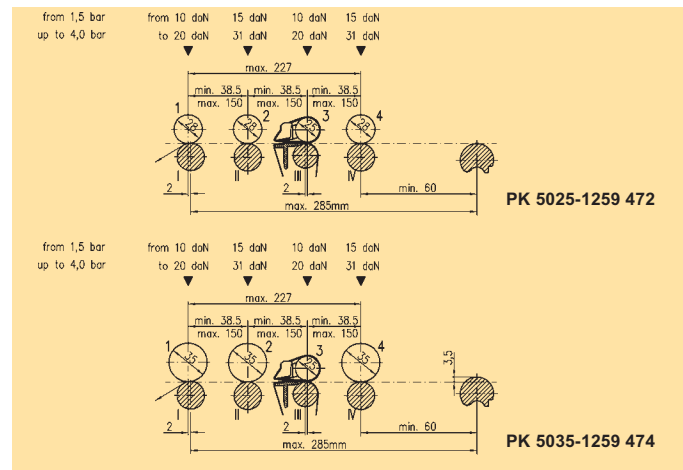

Fig. D: Draft arrangement PK 5000 for 4-roller version

Sliver

The slivers counts normally used in mills practice are between approx. 3.4 and 4.6 ktex (Nm 0.30 - Nm 0.20). Sliver counts in this range guarantee ideal speed frame draft. Processing slivers of 3 ktex or finer on speed frame draft systems, is not recommended due to lacking fibre cohesion and the resultant risk of faulty draft during sliver feed from can to draft system. The maximum sliver count may not exceed 6 ktex (Nm 0.17).

Draft sizes

Total draft

The amount of total draft on a four- or three-roller double-apron draft system is between 5 and 18 fold, a range of 5-12 fold providing the best results. Drafts greater than 12 fold are seldom employed as the total draft on a ring frame should be as high as possible, for yarn quality reasons. Drafts lower than 5 fold should not be applied. For the 4-roller double-apron draft system a draft of approx. 1.05 is used as a support for condensation between the roller pair I/1 and II/2.

Rear draft

The task of the rear draft is to tension the fibre material in the rear zone and draw it parallel. Rear drafts of between 1.12 and 1.18 are normally used in practice.

Draft fields

Front zone

The front zone settings depend on the type of top apron cradle, the diameters of top and bottom rollers and the space required for the front zone condensers being used. The adjustment values will be found in the following figures E and F. A precondition for good spinning results is the correct adjustment of the individual draft system elements. A greater fibre mass of the sliver leads to increased friction of the fibres and thus effective auto-control during the draft process. Special attention must be given here to the selection of the correct width for opening X. Excessive control in the front zone may lead to faulty draft or undrafted sections. Undrafted sections in the roving may, however, also be caused by selecting a freegauge distance that is too narrow. Should such draft faults occur, the freegauge can be regulated by adjusting the fronting of the front top roller or by regulating the bottom roller distance. If this is not enough even when high load is set on the front top roller, the front zone of the speed frame must be extended.

Rear zone

The rear zone setting depends on the fibre mass, the fibre length and the draft qualities of the fibre material to be spun.

Zone settings and maximum fibre length for PK 5000

Weighting arm	Top apron cradle	Bottom roller diameter				Draft field mm			Total draft field GF max	Fibre length max. mm
		I	II	III	IV	HF	VF min	VF usual ¹⁾		
PK 5025-1259 472	OH 5022	30/32	30/32	25/27	30/32	49	40.5	1)	225	45
	60					40.5	**	225	54	
PK 5035-1259 474	OH 5022	30/32	30/32	25/27	30/32	49	40.5	1)	225	45
	60					40.5	**	225	54	
PK 5025-1259 471	OH 5022	30/32	25/27	30/32	-	49	40.5	1)	221	45
	OH 5042					60	40.5	1)	221	54
	OH 5245					76	40.5	1)	221	60
PK 5035-1259 473	OH 5022	30/32	25/27	30/32	-	49	40.5	1)	221	45
	OH 5042					60	40.5	1)	221	54
	OH 5245					76	40.5	1)	221	60

**Extension of the usability range because of $GF_{max} = 225$ mm

¹⁾ VF_{usual} depends on fibre length and fibre material.

Fig. E: Zone settings and maximum fibre length PK 5000

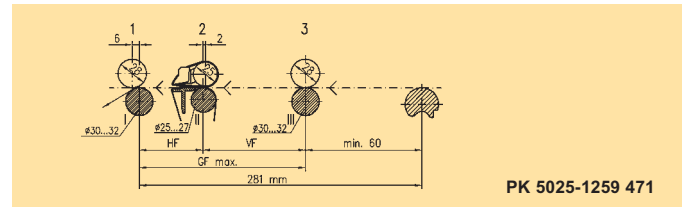

PK 5025-1259 471

Fig. F: Draft field settings PK 5000

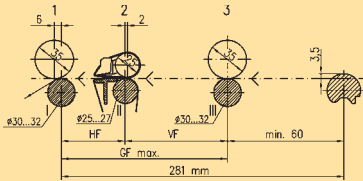

PK 5035-1259 473

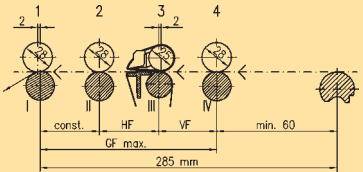

PK 5025-1259 472

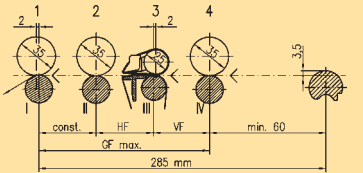

PK 5035-1259 474

Fig. F: Draft field settings PK 5000

Roller loading

Types	Load stages (daN)			
	Front 1	Middle 2	Middle 3	Rear 3 Rear 4
PK 5025-1259 472	10 up to 20	15 up to 31	10 up to 20	15 up to 31
PK 5035-1259 474	10 up to 20	15 up to 31	10 up to 20	15 up to 31
PK 5025-1259 471	17 up to 36	12 up to 21	-	16 up to 32
PK 5035-1259 473	17 up to 36	12 up to 21	-	16 up to 32

The weighting arms are supplied with non-oiled compressed air via a central air supply system. This air supply system is installed on the speed frame as a T-distributor (see fig. G).

The working pressure onto the top rollers can be set infinitely and centrally through the working pressure and thus, an optimum adjustment to the fibre material is possible.

Due to the pneumatic spring in the weighting arm the working pressure is transferred into the saddle load directly via the pressure plates of the individual weighting elements.

The setting is made with a corresponding control device in the pneumatic unit which incorporate an appropriate indicator instrument for this purpose.

The roller loads on rear, apron and front top rollers are interlinked at a fixed ratio.

This ratio is determined by the pressure plate size of the weighting elements. When the working pressure is changed, this ratio remains constant.

The correlation between the set working pressure and the saddle load of all top rollers in the weighting arm is shown as a graph in fig. H.

In most applications, a working pressure of 2.4 - 2.6 bar is sufficient. In the case of man-made fibres or blends, a working pressure of 3.4 to 3.5 bar can be of advantage.

Partial load relieve

The weighting arm PK 5000 offers the possibility of central partial load relieve. This is applied to the top rollers due to the inherent elasticity of the pneumatic spring. It takes effect automatically when the ring frame is turned off by the main switch.

The partial load has been selected in such away that top roller cots are protected from permanent deformation (no moiré-effect!). After switching on the speed frame, the preset weighting pressure builds up automatically. When this pressure has been reached, the weighting arms are ready for operation.

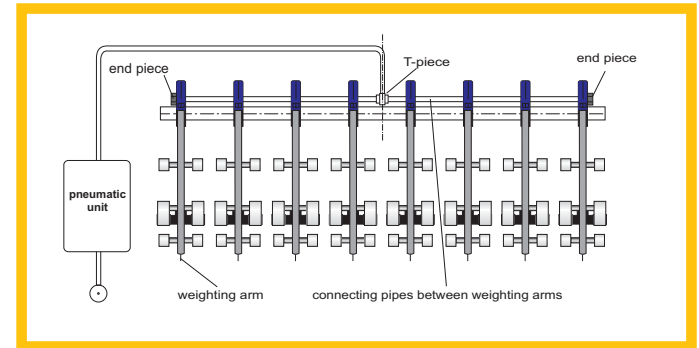

Fig. G: Air supply system for PK 5000 series

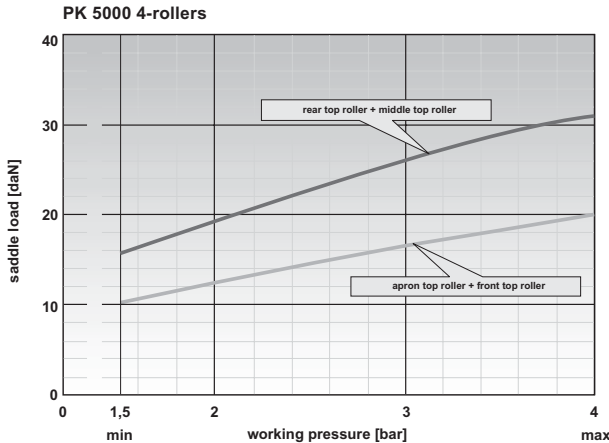
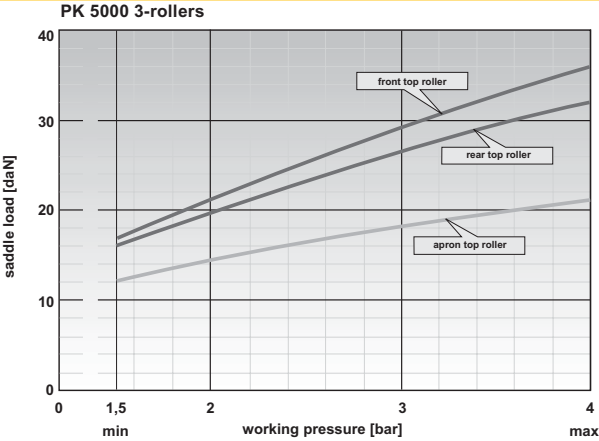

Fig. H: Correlation between saddle load and working pressure for PK 5000 series

Top apron cradle system

Weighting arms of PK 5000-series can be fitted with short staple cradle (OH 5022), medium staple cradle (OH 5042) or long staple cradle (OH 5245).

Top apron cradles OH for		Applications of the cradles
PK 5025-1259 471 PK 5035-1259 473	PK 5025-1259 472 PK 5035-1259 474	
OH 5022 short staple	OH 5022 short staple	Cotton and man-made fibres, pure / blends, of up to approx. 45 mm max. fibre length.
OH 5042 medium staple	OH 5042 medium staple	Cotton and man-made fibres, pure / blends, of up to approx. 54 mm max. fibre length.
OH 5245 long staple	-	Man-made fibres of up to approx. 60 mm max. fibre length.

Opening X at apron release point

The opening X between the guide edge of the top apron cradle and the bottom apron nose bar determines the intensity with which the fibre material is controlled and guided between top and bottom aprons. In order to be able to adapt draft conditions to good fibre control and fibre guidance corresponding to the fibre mass present in the front zone, the so-called opening X can be regulated via the top apron distance clips.

The opening X is adjusted via special distance clips affixed to the guide edge of the top apron cradle. To distinguish them and to make the opening X simpler to check, the top apron distance clips have different colours (see fig. J).

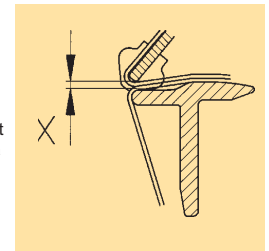

Fig. I: Opening X

Distance clips OLC		Top apron cradle for PK 5000		
		OH 5022 (short)	OH 5042 (medium)	OH 5245 (long)
Colour	Ref. No.	Apron top roller 25 mm Ø	Apron top roller 25 mm Ø	Apron top roller 25 mm Ø
white	OLC-0964 104	3.4	3.5	3.6
grey	OLC-0964 105	3.8	3.9	4.1
black	OLC-0964 106	4.4	4.4	4.6
orange	OLC-0030 491	4.7	4.7	5.0
beige	OLC-0964 107	5.1	5.1	5.4
green	OLC-0964 108	5.9	5.9	6.4
blue	OLC-0964 109	8.9	8.9	8.9
brown	OLC-0964 110	11.1	11.1	11.1

Fig. J: Distance clips OLC in connection with TEXParts top apron cradle (opening X in mm)

Top aprons for PK 5000

The dimensions of top aprons have been standardised and are determined by the type of OH top apron cradle and the diameter of the apron top roller used (see fig. K).

Top apron cradles OH Ref. No.	Gauge Tw [mm]	Top aprons general designation	Top roller Type Ref. No.	Basic equipm.* Distance clips Ref. No.
OH 5022-1259 297	110	PR 40	LP 1015-0025 228	OLC-0964 104 OLC-0964 106 OLC-0964 108
OH 5042-1259 506	110	PR 4010	LP 1015-0025 228	OLC-0964 104 OLC-0964 106 OLC-0964 108
OH 5245-1260 370	110	PR 4011	LP 1015-0025 228	OLC-0964 104 OLC-0964 106 OLC-0964 108

* Distance clips are not included in standard OH supply.

Fig. K: Range of top apron cradles, top aprons and distance clips for PK 5000 weighting arms

Top roller cots

When freshly covered and ground, the rear and front top rollers of the PK 5025 have a diameter of 28 mm. Due to the bigger rear and front top roller diameters (35 mm), the PK 5035 is mainly used for wider fibre ranges. Quality and type of fibre material to be spun and running properties are decisive for the choice of cot. For top roller cots (rear, front - LP 1015), a Shore hardness of 83° is usual. As apron top roller, the LP1015 with cot (25 mm diameter) is used. TEXParts recommends cots with Shore hardness 80°.

Grinding

Cot grinding intervals depend on the following:

- cot quality
- type of fibre material
- finishing agents or other additives
- climatic conditions
- weighting pressure of the top roller
- top roller running time.

Grinding the spinning cots must not reduce the cot diameters by more than 3 mm.

Within this diameter reduction range, no re-adjustment of the weighting arm height is necessary. The cot of the apron top roller LP 1015 may not be ground, as the top apron dimensions are matched to apron top rollers of fixed diameters.

Bottom apron nose bar

The bottom apron nose bar supports the bottom apron as it passes through the front zone. The recessed shape of the nose bar provides good fibre guidance and control through the double-apron unit.

The three different top apron cradle sizes OH 5022, OH 5042 and OH 5245 are to be matched up with the corresponding bottom apron nose bars (see chapter 5, page 64-65).

Condensers

In speed frame draft systems, the task of the condensers is to evenly fold flank fibres back into the fibre material. The condenser should be neither too narrow, nor too wide in order to avoid possible faults in the draft process (see fig. M).

For reasons of process reliability, closed condensers are recommended for use on speed frames, with the exception of the front zone condenser. Favourable cross-section ratios for the delivery aperture of closed condensers (height x width) of 1:4 or 1:5 have proved their worth.

Rear roving guide

The rear roving guide 1 is to be positioned as close as possible to the rear pair of rollers (see figs. L/M). When selecting rear roving guide, take the position and type of the roving-guide rail into account. If the opening widths have been correctly chosen, any tangled sliver portions will be smoothed out and the fibre material will flow unchecked.

Rear zone condenser

The rear zone condenser 2 is positioned in front of the double-apron unit (see fig. L). The lower edge of the front aperture lies on the draft plane. Its task is to lightly gather the fibre material before it enters the front zone or the double-apron unit and gently fold any flank fibres which may have spread outwards back into the sliver body. Make sure that the opening width of the rear zone condenser is not too small, otherwise faulty draft may occur.

The simplest and most reliable method of checking whether the passage aperture of the rear zone condenser has been correctly selected is shown in fig. M.

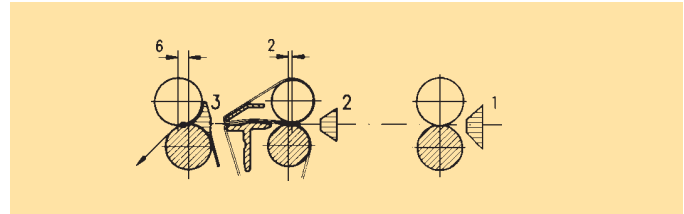

Fig. L: Fronthang of front top roller and backhang of middle top roller and alignment of roving guides resp. condensers

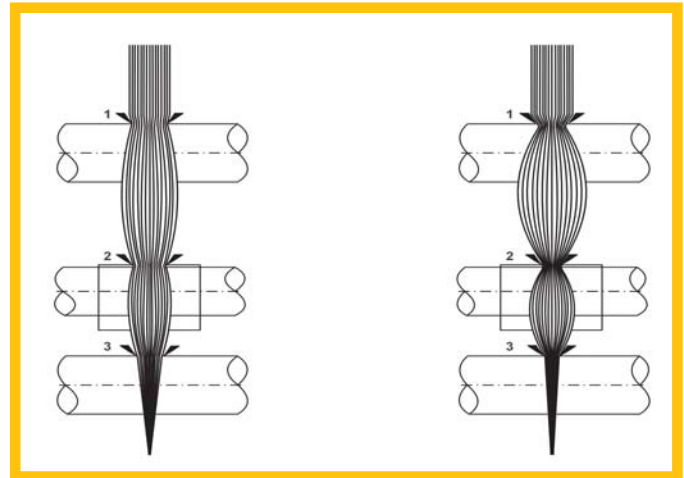

Fig. M: Correct opening width (left) and too narrow opening width (right) of condenser

Front zone condenser

The use of front zone condensers in speed frame draft systems has become generally accepted. Condensers open at the bottom have proved particularly useful.

The front zone condenser 3 gathers outspread flank fibres and returns them to the sliver (see fig. M). Subsequently the spinning delta is made smaller and roving breakages, lapping and fly formation are reduced. Particular care should be taken to precisely match the opening widths of the condensers not only to the roving gauge but also to the fibre characteristics (see table below). In-house trials should be carried out to do this.

Front zone condenser Ref. No.	Roving count	Delivery aperture width and colour of front zone condenser
KL-0998 282	680 tex to 400 tex or Nm 1,5 to 2,5 (Ne 0,9 to 1,48)	6 mm (yellow)
KL-0998 283	1000 tex to 680 tex or Nm 1,0 to 1,5 (Ne 0,6 to 0,9)	9 mm (colourless)
KL-0998 284 KL-0998 285	over 1000 tex or Nm 1,0 (Ne 0,6)	12 mm (black) or 16 mm (green)

Series PK 1500 weighting arms for cotton speed frames

Series PK 1500 weighting arms are intended for 3-roller and 4-roller double apron draft systems on cotton speed frames. They are suitable for spinning cotton, man-made fibres or blends thereof up to approx. 60 mm length.

The PK 1500 weighting arm series comprises types PK 1500-0962 604 (28 mm Ø top rollers) and PK 1500-0962 602 (35 mm Ø top rollers) for 3-roller double apron draft systems and type PK 1500-0001 938 (28 mm Ø top rollers), which is designed for 4-roller double apron draft equipment.

The 4-roller version differs from the 3-roller version in having an additional condensing zone between the roller pairs I/1 and II/2 (see figs. A/B).

By deliberately condensing the fibre material in this zone, a reduction in the spinning delta is achieved, thus improving the incorporation of the fibres into the roving. This results in the following important advantages:

- reduced number of thread breakages (improved process reliability)
- increased efficiency
- greater package density at speed frame bobbin thanks to the more compact roving.
- reduced fly formation.

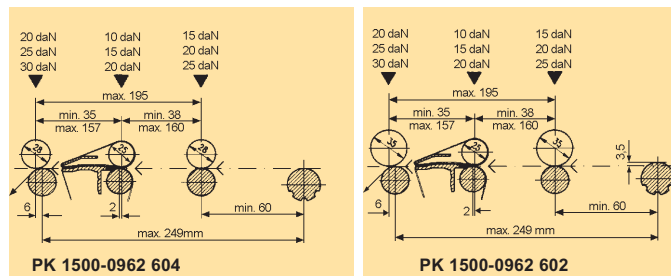

Fig. A: Draft arrangements PK 1500, 3-roller version

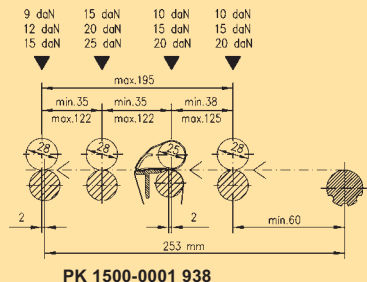

Fig. B: Draft arrangement PK 1500, 4-roller version

Drawing frame sliver feed

The counts of drawing frame sliver feed normally used in mills are between approx. 3.4 and 4.6 ktex (Nm 0.30 - Nm 0.22). Sliver counts in this range guarantee ideal speed frame draft. It is not recommended to process slivers of 3 ktex or finer on speed frame draft systems due to lacking fibre cohesion and the resultant risk of faulty draft during sliver feed from can to draft system.

The maximum sliver count may not exceed 6 ktex (Nm 0.17).

Draft ratios

Total draft

The ratio of total draft on a four- or three-roller double-apron draft system is between 5- and 18-fold, a range of 5-12-fold providing best results. Drafts higher than 12-fold are rarely employed as the total draft on a ring frame should be as high as possible, for reasons of yarn quality.

It's not recommended to operate speed frames at lower drafts than 5 as faulty draft may occur at such low total draft ratios. For the 4-roller double-apron draft system a draft tension of approx. 1,05 is used as a support for condensation between roller pair I/1 and II/2 (fig. D).

Rear draft

Rear draft is required to tension the fibre material in the rear zone and draw it parallel. Rear drafts of between 1.12 and 1.18 are normally used in practice.

Draft fields

Front zone

The front zone settings depend on the dimensions of the top apron cradle, diameters of top and bottom rollers and the space required for the front zone condensers. The adjustment values are listed in fig. C and fig. D. Correct adjustment of the individual draft system elements is the prerequisite for good spinning results. A larger quantity of fibres of the drafter sliver produces increased friction of the fibres and thus effective auto-control during the draft process.

Special attention must be given here to the selection of the correct width of the opening X. Excessive control in the front zone may lead to faulty drafted or undrafted sections. Undrafted sections of the speed frame roving, however, also may be caused by a selected slip-draft distance that is too narrow. Should such draft faults occur, then the slip-draft distance can be regulated by adjusting the overhang of the front top roller. If this is not enough, even when high load is set on the front top roller, the front zone of the speed frame must be extended.

Rear zone

The rear zone setting depends on the fibre mass, fibre length and draft qualities of the fibre material to be spun.

Zone settings and maximum fibre length for PK 1500

Weighting arm	Top apron cradle	Bottom roller diameter				Draft field mm			Total draft field GF mm max	Fibre length max. mm
		I	II	III	IV	HF	VF min	VF usual ¹⁾		
PK 1500-0001 938	OH 514	30/32	30/32	25/27	30/32	49	45	1)	193	45
PK 1500-0962 604	OH 514	30/32	25/27	30/32	-	49	40	1)	189	45
	OH 534					60	40	1)	189	54
	OH 524					76	40	1)	189	60
PK 1500-0962 602	OH 514	30/32	25/27	30/32	-	49	40	1)	189	45
	OH 534					60	40	1)	189	54
	OH 524					76	40	1)	189	60

¹⁾ VF depends on the fibre to be spun and fibre length.

Fig. C: Zone settings and maximum fibre length PK 1500

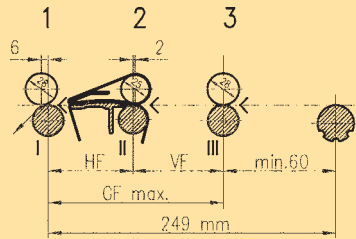

PK 1500-0962 604

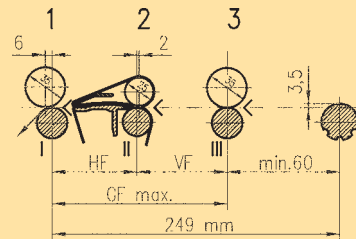

PK 1500-0962 602

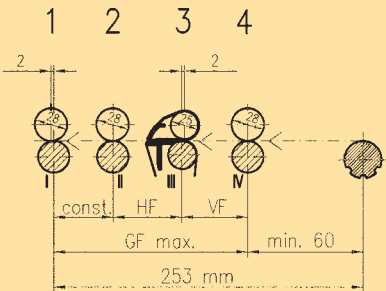

PK 1500-0001 938

const. = 34 mm

The figure mentioned is the shortest possible distance of the bottom rollers depending on PK construction.

Fig. D: Zone settings PK 1500

Roller loading

In speed frames, the load stage to be set on the weighting elements is determined by the type of fibre, the quantity of fibres and the amount of total draft.

Basically, the larger the quantity of fibres, the higher the load is. For minor total drafts, comparatively high loads have proved their worth. The various loads set on the weighting elements are matched to their respective positions (rear, apron and front top rollers). The fact that the weighting elements of the PK 1500 weighting arm are adjustable in three load stages (fig. E) means that they can be adapted to all spinning conditions commonly found in practice.

As a basic setting for all weighting elements we recommend the middle load stage "green". Depending on the respective requirements, a different load stage can be set at the individual elements.

The processing of man-made fibres and blends generally requires higher loads. Load that are too low may lead to faulty draft resulting in pull-through and undrafted sections. By comparison with the three-roller zone draft system, lower front roller loads are used on four-roller step drafters as only a tensioning draft of 1,05 is employed in the condensing zone in front of the front pair of rollers (I/1 - II/2).

Types	Load stages [daN]			
	Front1	Middle2	Middle 3	Rear 3(4)
PK 1500-0001 938	9-12-15	15-20-25	10-15-25	10-15-20
PK 1500-0962 604	20-25-30	10-15-20	--	15-20-25
PK 1500-0962 602	20-25-30	10-15-20	--	15-20-25
Colour ¹⁾	b - g - r	b - g - r	b - g - r	b - g - r

Fig. E: Load stages for PK 1500-series

¹⁾ colour on the eccentric load selector: b = black, g = green, r = red

Load adjustment

Load adjustment is effected by means of an eccentric load selector activated by a special wrench (fig. F). Three load stages can be set on each weighting element. The three different load settings can be identified by the code colour on the eccentric load selector on top of the guide arm.

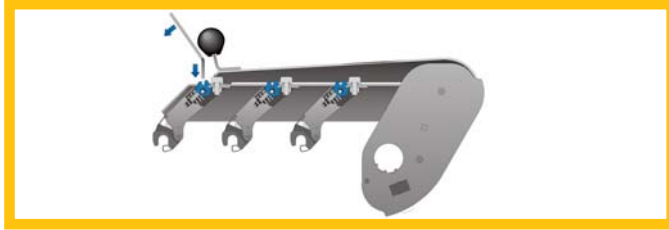

Fig. F: Load adjustment of weighting elements PK 1500

Top apron cradle system

Weighting arms of PK 1500 series can be fitted with short (OH 514), medium (OH 534) or long (OH 524) top apron cradles.

Top apron cradles OH for		Applications of the cradles
PK 1500-0962 604 PK 1500-0962 602	PK 1500-0001 938 ¹⁾	
OH 514 ²⁾ short	OH 514 short	Cotton and man-made fibres, pure / blends, of up to approx. 45 mm max. fibre length.
OH 534 medium	-	Cotton and man-made fibres, pure / blends, of up to approx. 54 mm max. fibre length.
OH 524 long	-	Man-made fibres of up to approx. 60 mm max. fibre length.

¹⁾ For fibre lengths up to about 45 mm.

²⁾ With diameters of the top rollers 35-33-35 mm OH 514 (short) is not to be used.

Opening X at apron release point

The opening X between the guide edge of the top apron cradle and the bottom apron nose bar determines the intensity with which the fibre material is controlled and guided between top and bottom aprons. In order to be able to adapt draft conditions to good fibre control and fibre guidance corresponding to the fibre mass present in the front zone, the so-called opening X can be regulated via the top apron distance clips.

The opening X is adjusted via special distance clips affixed to the guide edge of the top apron cradle. To distinguish them and to make the opening X simpler to check, the top apron distance clips have different colours (see fig. H).

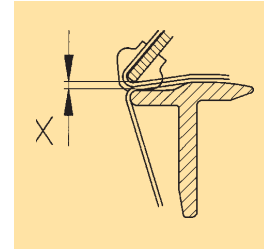

Fig. G: Opening X

		Top apron cradle		
		OH 514 (short)	OH 534 (middle)	OH 524 (long)
Colour	Ref. No.	Apron top roller 25 mm dia.	Apron top roller 25 mm dia.	Apron top roller 25 mm dia.
white	0964 104	3,5	3,6	3,6
grey	0964 105	4,0	4,1	4,1
black	0964 106	4,6	4,6	4,6
orange	0030 491	5,0	5,0	5,0
beige	0964 105	5,4	5,4	5,4
green	0964 108	6,5	6,5	6,4

Fig. H: Distance clips OLC in connection with TEXParts top apron cradle (opening X in mm)

Top aprons for PK 1500

The dimensions of top aprons have been standardised and are determined by the type of OH top apron cradle and the diameter of the apron top roller used (see fig. I).

Top apron cradles OH Ref. No.	Gauge Tw [mm]	Top aprons general designation	Top roller Type Ref. No.	Basic equipm.* Distance clips Ref. No.
OH 514-0962 745	100	PR 40	LP 1017-0013 010	
OH 514-0962 746	110	PR 40	LP 1017-0013 011	
OH 514-0962 747	130	PR 40	LP 1017-0013 012	
OH 534-0962 764	100	PR 4010	LP 1017-0013 010	
OH 534-0962 765	110	PR 4010	LP 1017-0013 011	
OH 534-0962 766	130	PR 4010	LP 1017-0013 012	
OH 524-0962 755	110	PR 4011	LP 1017-0013 011	

*Basic equipment of distance clips. Clips are not included in standard OH supply.

Fig. I: Range of top apron cradles, top aprons and distance clips for PK 1500 weighting arms

Top roller cots

When newly covered and ground, the rear and front top rollers of the PK 1500-0962 604 have a diameter of 28 mm. Due to the bigger rear and front top roller diameters (35 mm), the PK1500-0962 602 is mainly used for longer fibre ranges (60 mm).

Quality and type of fibre material to be spun and running properties are decisive for the choice of cot. For top roller cots (rear, front - LP 1015), a Shore hardness of 83° is usual. As apron top roller, the LP 1017 with cot is used. TEXParts recommends cots with Shore hardness 80°.

Grinding

Cot grinding intervals depend on the following points:

- cot quality
- the type of fibre material
- finishing agents or other additives
- climatic conditions
- weighting pressure of the top roller
- top roller running time.

Grinding the spinning cots must not reduce the cot diameters by more than 3 mm. Within this diameter reduction range, no readjustment of the weighting arm height position is necessary. The cot of the apron top roller LP 1017 may not be ground, as the top apron dimensions are matched to apron top rollers of fixed diameters.

Bottom apron nose bar

The bottom apron nose bar supports the bottom apron as it passes through the front zone. The recessed shape of the nose bar provides good fibre guidance and control through the double-apron unit.

The three different top apron cradle sizes OH 514, OH 534 and OH 524 are to be matched up with the corresponding bottom apron nose bars (see chapter 5, page 64-65).

Condensers

In speed frame draft systems, the task of the condensers is to evenly fold flank fibres back into the fibre material. The condenser should be neither too narrow, nor too wide in order to avoid possible faults in the draft process (see fig. K).

For reasons of process reliability, closed condensers are recommended for use on speed frames, with the exception of the front zone condenser. Favourable cross-section ratios for the delivery aperture of closed condensers (height x width) of 1:4 or 1:5 have proved their worth.

Rear roving guide

The rear roving guide 1 is to be positioned as close as possible to the rear pair of rollers (see fig. J). When selecting rear roving guide, take the position and type of the roving-guide rail into account. If the opening widths have been correctly chosen, any tangled sliver portions will be smoothed out and the fibre material will flow un-checked.

Rear zone condenser

The rear zone condenser 2 is positioned in front of the double-apron unit (see fig. J). The lower edge of the front aperture lies on the draft plane. Its task is to slightly gather the fibre material before it enters the front zone or the double-apron unit and to gently fold any flank fibres which may have spread outward back into the sliver body. Make sure that the opening width of the rear zone condenser is not too small, otherwise faulty draft may occur. The simplest and most reliable method of checking whether the passage aperture of the rear zone condenser has been correctly selected is shown in fig. K.

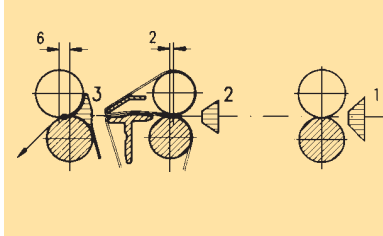

Fig. J: Fronthang of front top roller and backhang of middle top roller and alignment of roving guides resp. condensers

Front zone condenser

The use of front zone condensers in speed frame draft systems has become generally accepted. Condensers open at the bottom have proved particularly useful.

The front zone condenser 3 gathers outspread flank fibres and returns them to the sliver (see fig. K). Subsequently the spinning delta is made smaller and roving breakages, lapping and fly generation are reduced. Particular care should be taken to precisely match the opening widths of the condensers not only to the roving gauge but also to the fibre characteristics (see table below). In-house trials should be carried out for exact determination of the opening width.

Front zone condenser Ref. No.	Roving count	Delivery aperture width and colour of front zone condenser
KL-0998 282	680 tex to 400 tex or Nm 1,5 to 2,5 (Ne 0,9 to 1,48)	6 mm (yellow)
KL-0998 283	1000 tex to 680 tex or Nm 1,0 to 1,5 (Ne 0,6 to 0,9)	9 mm (colourless)
KL-0998 284 KL-0998 285	over 1000 tex or Nm 1,0 (Ne 0,6)	12 mm (black) or 16 mm (green)

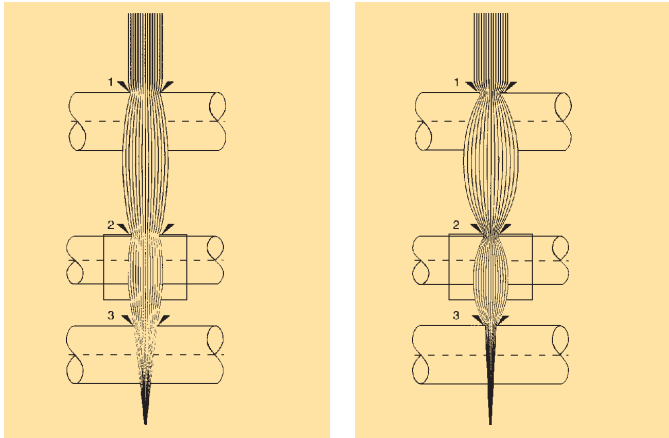

Fig. K: Correct opening width (left) and too narrow opening width (right) of condenser

Series PK 6000 weighting arms for worsted ring frames pneumatic load principle

The PK 6000 weighting arm is suitable for spinning wool, man-made fibres and blends of these materials as well as dry-spun bast fibres up to a fibre length of about 200 mm. The 3-roller double-apron draft system works according to the slip-draft principle, with a recessed roller as the apron top roller. Depending on the type of preparation, twisted roving or French-type roving can be fed to the draft system. The weighting pressures on the top rollers are set infinitely and centrally using a non-oiled compressed air supply system. The latter is installed on the ring spinning frame in the form of a ring main in which the weighting arms are connected. The ring main is supplied with controlled air pressure via a pneumatic unit. The saddle load onto the top rollers depends on the pressure in the ring main and on the size of the pressure plates in the weighting elements. The PK 6000 weighting arm permits the central partial load relieve when the compressed air system is switched off.

- | | |
|--|--|
| 1 Bracket | 8 Arm |
| 2 Push-in connection for air pipe | 9 Middle weighting element (with pressure plate) |
| 3 Leakage air display | 10 Handle |
| 4 Eccentric screw for height adjustment | 11 Front weighting element (with pressure plate) |
| 5 Valve | |
| 6 Pneumatic spring | |
| 7 Rear weighting element (with pressure plate) | |

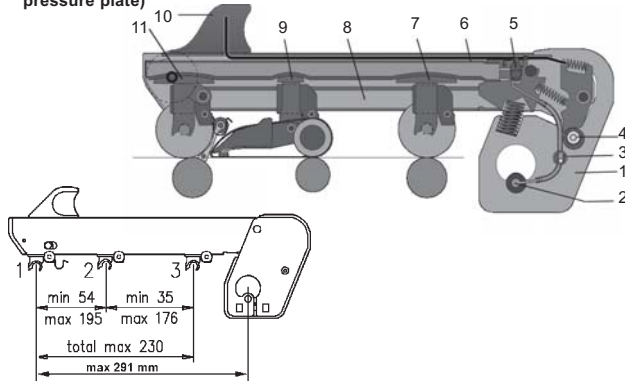

Fig. A: Weighting arm PK 6000-1252 924

Draft sizes

Total draft

This is determined by the type, composition and preparation of the fibre material to be processed. The total draft ranges set forth in tab. 5 have proved to be practical for the various types of material.

Draft sizes applicable in the mill must be determined by in-house spinning trials using optimum yarn quality, with due account being taken of acceptable machine operating conditions.

Fibre material	Usual number of total drafts	Remarks
Wool	12-30	In contrast to French-type rovings, higher total drafts should be selected for twisted rovings.
Wool/man-made fibres	18-35	
Man-made fibres		In the case of blends, higher total drafts become possible as the proportion of man-made fibre
Cut staple	20-40	
Filament tow	30-60 increases	

Fig. B: Total draft range

Rear zone draft

In the case of 3-roller double-apron draft systems using the slip-draft method (recessed roller), tension of the roving in the rear draft zone is necessary. The roving should be well stretched when it enters the double apron unit. Rear drafts of 1.10 to 1.25 have proved to be best.

Draft fields

Total draft field

In the PK 6000 the maximum total draft field $GF_{max} = 223$ mm. The total draft field can be defined as approximately:

$$GF = \text{maximum fibre length} + \text{approx. 15 \%}$$

Rear zone setting

The rear zone setting (VF) is generally dependent on the maximum fibre length. To determine the rear zone setting, the standard dimension (main draft = 105 mm) must be deducted from the total draft field GF ascertained:

$$VF = GF \text{ (calculated)} - 105 \text{ mm (standard dimension)}$$

With twisted roving, it may be necessary to set a higher rear zone distance. In this connection, we recommend that in-house trials be carried out.

Front zone setting

The front zone setting (HF) is determined by the top apron cradle system OH 6022 in the PK 6000. For the bottom roller diameters given in fig. C, the front zone setting constant being 105 mm.

To improve the apron running properties, the apron top roller is set with a 2 mm backhang. When front zone condensers are used, the front top roller is set with 7 mm fronthang. Without front zone condenser or special condensers, a smaller fronthang can also be selected.

Draft field width and maximum fibre length PK 6000-1252 924

Weighting arm	Top apron cradle	Bottom roller diameter			Draft field mm			Total draft field GF mm max	Fibre length max. mm
		I	II	III	HF	VF min	VF usual ¹⁾		
PK 6000-1252 924	OH 6022	35/40	27/30,5	35/40	105	57 ¹⁾	2)	223	200

¹⁾ Without rear zone condenser the rear zone setting reduces to 45 mm at min.

²⁾ Depends on fibre length and roving material.

Roller loading

The weighting pressure onto the top rollers can be set infinitely and centrally through the working pressure and thus, an optimum adjustment to the fibre material is possible.

Due to the pneumatic spring in the weighting arm the working pressure is transformed into the saddle load directly via the pressure plates of the individual weighting elements.

The roller loads on rear, apron and front top rollers are interlinked at a fixed ratio.

This ratio is determined by the pressure plate size of the weighting elements. When the working pressure is changed, this ratio remains constant.

The correlation between the set working pressure and the saddle load of all top rollers in the weighting arm is shown as a graph in fig. D.

In most applications, a working pressure of 2.5 - 3.0 bars is sufficient. In the case of fibre materials with poor draft properties, a weighting pressure of 3.0 to 4.0 bar can be of advantage.

In the case of fibre material with low fibre adhesiveness or pressure-sensitive fibres, a weighting pressure of 1.5 to 2.5 bars is recommended. The fibres are not gripped at the apron top roller designed as a recessed roller. As a result of the system design the working pressure for the apron top roller is therefore lower than for the rear and front top roller (see lower characteristic line in graph of fig. D).

Partial load relieve

The weighting arms PK 6000 offer the possibility of central partial load relieve. This is applied to the top rollers thanks to the inherent elasticity of the pneumatic spring. It takes effect automatically when the ring frame is turned off at the main switch. The partial load has been selected such that it reliably prevents intrusion of the yarn twist into the draft field, and even soft top roller cots are protected from permanent deformation (no moiré effect!). After switch-on of the ring frame, the preset weighting pressure builds up automatically. When this pressure has been reached, the weighting arms are ready for operation.

A) With long bottom apron system

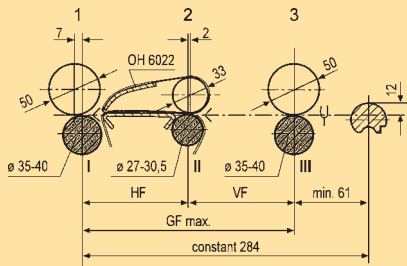

Fig. C: Draft field width and maximum fibre length PK 6000

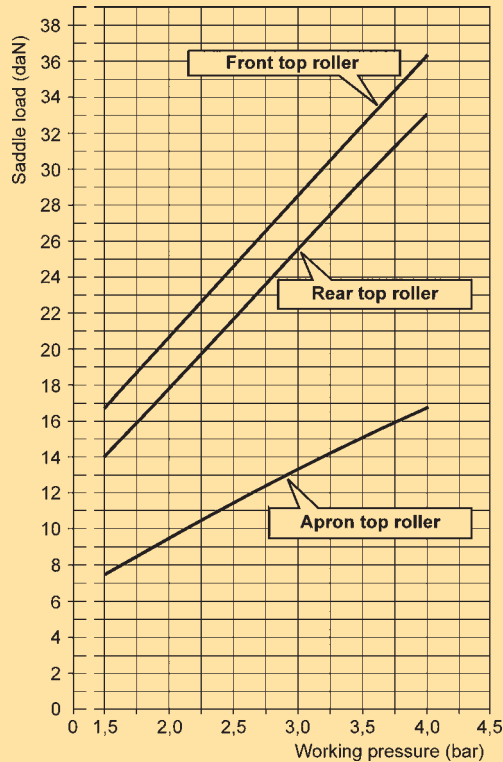

Fig. D: Correlation between saddle load and set working pressure for PK 6000

Top apron cradle system

The top apron cradle system OH 6022 is available for the weighting arm PK 6000. The design principle of the OH 6022 permits compensation of apron tolerances with its individualised apron tensions.

The individualised apron tensional results in low strain on the fibre and simultaneously in gentle fibre guidance during draft.

The low-friction apron running ensures a low-drive torque and long apron service-life.

The top aprons can be changed quickly and easily without removal of the top apron cradle system, even while still installed in the ring frame.

The contact pressure on the distance clip OLC is introduced directly via the apron top roller weighting element.

Fig. E shows the top apron cradle OH 6022 with distance clip selection, the appropriate apron top rollers and the appropriate top apron designations.

Top apron cradle types Ref. No.	Gauge Tw [mm]	Top apron roller	Top apron	Basic equipm.* Distance clips	Colour
OH 6022	75	LP 1014-1253 740	PR-1253 678	OLC-0964 120 OLC-0004 587 OLC-0004 588	black
OH 6022	82.5	LP 1015-1253 744	PR-0022 858		beige
					green

* Distance clips are not included in standard OH supply

Fig. E: Top apron cradles and distance clips for PK 6000

Opening X at apron release point

The distance between the deflecting edges of the top apron cradle and the bottom apron nose bar (= opening X) determines, with a given apron thickness, the intensity of the fibre guidance and control (fig. F). The opening X is set with the aid of special distance clips that are mounted on the top apron cradle.

For differentiation and easy checking of the various openings, the distance clips are in different colours (fig. G). The opening necessary for a certain fibre material is mainly dependent on the fibre type, the fibre mass, on the kind of bottom apron nose bar and on the method and quality of the fibre preparation and the fineness of the spun yarn.

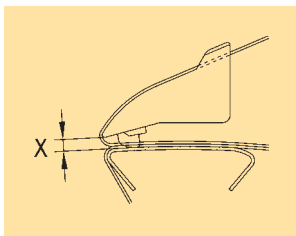

Fig. F: Opening X

Distance clip OLC Ref. No.		Opening X [mm] with top apron cradle OH 6022
OLC-0964 120	black	2.6
OLC-0004 587	beige	3.7
OLC-0004 588	green	4.1
OLC-0004 589	pink	5.6
OLC-0964 123	blue	8.0

Fig. G: Distance clips OLC and opening X

Top rollers and cots

In the PK 6000-weighting arm, the rear and front top rollers with newly fitted cots should have 50 mm cot diameters after first grinding. Subsequent grinding of the cots may reduce the cot diameter of rear and front top rollers by a maximum of 3 mm. Within this range it is not necessary to readjust the height of the weighting arm or increase the loading via increasing the air pressure.

The **system diameter of the apron top roller is 33 mm**

and must be kept precisely on account of the specified apron length.

The top rollers are supplied as standard as top rollers without cot. If required, however, TEXParts can also supply top rollers with cot fitted and ground. The cot quality can be specified by the customer. The cot diameters of top rollers with newly fitted cots are shown in fig. H.

The grinding cycles for the rear and front top rollers depend on:

- cot quality
- weighting pressure
- type of fibre to be processed
- production speed
- finishing agents or other additives
- climatic conditions
- top roller operating time.

In addition, in selecting the cot quality to suit the fibre, the cot should have a accurately shaped edge, true running and a good-grip surface. For rear and front top rollers, cots with a Shore hardness of 80° to 85° are recommended, and for apron top rollers 75° to 80°. Apron top rollers require, in view of differing roving yarn counts and differing fibre properties, different recess depths (T) (see fig. H).

Optimum values for the recess depths must be ascertained with due allowance for the feed material and the fibre properties by means of in-house trials performed by the spinning mills themselves.

Survey of dimensions of outer rings and cots

Rear and front top roller

Top roller	d ₁	d ₂	b	E
LP 1014	19	50	30/32	34

Apron top roller as recessed roller

Top roller	d ₁	d ₂	W	b	K	T	Feed sliver count
						0.5	for French-type rovings of approx. 1000 tex (Nm 1.0) and finer
						1.0	for French-type rovings of approx. 1000 tex (Nm 1.0) and coarser, twisted roving approx. 1000 tex (Nm 1.0) and finer
LP 1015	19	33	40	40	20		
LP 1014	19	33	32	34	18		
						1.5	for twisted rovings of approx. 1000 tex (Nm 1.0) and coarser sizes, also for fibre materials with poor draft properties

d₁ = outer ring diameter of version with cot [mm]

d₂ = diameter over cot [mm]

b = cot width [mm]

W = apron width [mm]

E = width of outer ring [mm]

T = recess depth [mm]

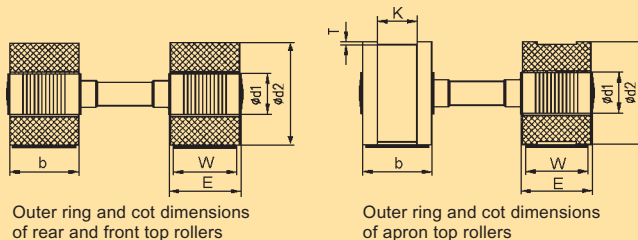

Fig. H: Top rollers with cot and outer ring dimensions for PK 6000

Recessed rollers

The recess depth of the apron top roller has a crucial effect on the intensity of fibre guidance and fibre control. It is an important instrument for achieving optimum yarn quality. Selected recess depths that are too low can impair both yarn quality and running properties. In practice, the recess depths listed in fig. H on the prior page are used.

If high loads are applied, an adequate recess depth must be assured to compensate for the flattening of the cot of the apron top roller.

Mono-clearer roller system

For cleaning the front top roller and preventing laps, a mono-clearer roller system is available for the PK 6000 weighting arm (fig. I).

The mono-clearer roller system is guided by a swivelling, spring-loaded clearer roller holder and lightly pressed against the top roller. Its exact parallel guidance ensures an excellent cleaning effect. It can be detached from the clearer roller holder for quick and easy cleaning.

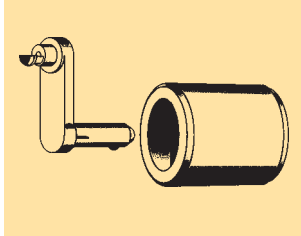

Fig. I: Mono-clearer roller system for PK 6000

Bottom apron nose bar

Long bottom apron system

The bottom apron nose bar supports the bottom apron as it passes the front zone. The slightly convex shape of the nose bar provides good fibre guidance and control in the main draft zone. The height of the nose bar generally is 2.5 mm above the draft plane 1 (see fig. L). In special cases a higher nose bar position (with interchangeable washer 2) of up to approx. 4 mm may be selected. A lower nose bar position (bar on a level with draft plane) may be more favourable in the case of fibres with high fibre adhesiveness.

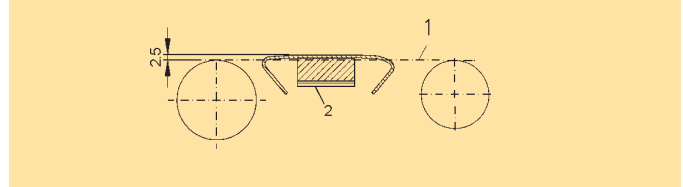

Fig. L: Draft plane with long bottom apron system

Condensers for PK 6000

Front zone condenser

The front zone condenser A is fitted in the main draft zone between the apron unit and the front pair of rollers (see fig. M). The task of the condenser is to selvedge the fibre material coming from the apron unit and prevent the flank fibres from spreading out. The front zone condenser is suspended from the guide head of the front weighting spring.

Care must be taken not to restrict the front zone condenser's range of play, as this may lead to a drop in quality.

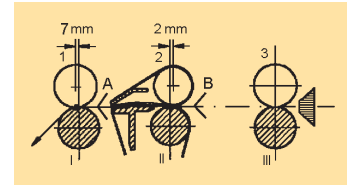

Fig. M: Fronthang of front top roller and backhang of middle top rollers and arrangement of condensers

Rear zone condenser

The rear zone condenser B is employed in the draft system of worsted ring frames (see fig. N). We recommend version KL-0997 469. This condenser is positioned ahead of the apron unit. Its shape is selected in such a way that the roving is smoothed as it runs into the following double-apron unit. The rear zone condenser is coupled to the rear roving guide and copies the latter's traverse motion.

The task of the rear zone condenser is to ensure that the roving only passes through the apron roller pair within the recessed portion of the upper apron roller. The traverse motion must be adjusted in such a way that this condition can reliably be fulfilled.

Front zone condenser Ref.No.	Gauge Tw in mm	Remarks	Symbol
KL-1248 233	75	Front zone condenser	
KL-1248 234	82.5	Pendulum secured by cheese-head screw	
KL-1246 243	75	Front zone condenser	
KL-1246 070	82.5	Pendulum with spring suspension	
Rear zone condenser Ref. No.			
KL-0997 469			

Fig. N: Condensers for PK 6000

Series PK 1601 weighting arms for worsted ring frames

TEXParts PK 1601-series weighting arm is mainly intended for 3-roller double-apron draft systems on worsted ring frames. **PK 1601 weighting arm** is suitable for spinning wool, man-made fibres or blends thereof types as well as dry-spun bast-fibres **up to approx. 200 mm length**.

A recessed roller is used as apron top roller. Thus the draft system works according to the slip-draft method having a single draft-field. Depending on the respective preparation method, twisted or French type rovings can be processed on the draft system.

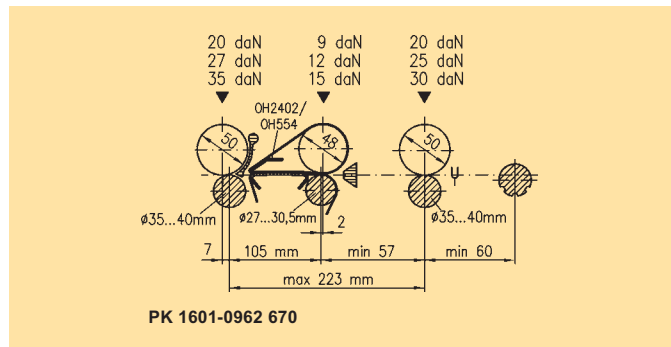

Fig. A: PK 1601 for worsted ring frames

Draft sizes

Total draft

The amount of total draft depends on the type and composition of the fibre material to be spun. The usual total draft ranges shown in fig. B for the various types of material have proved practicable. Precisely-applicable draft sizes must be determined by in-house trials, taking account of responsible frame-operating conditions and ideal yarn quality.

Fibre material	Usual number of total drafts	Remarks
Wool	12-30	In contrast to French-type rovings, higher total drafts should be selected for twisted rovings.
Wool/man-made fibres	18-35	
Man-made fibres		In the case of blends, higher total drafts become possible as the proportion of man-made fibre increases
Cut staple	20-40	
Filament tow	30-60 increases	

Fig. B: Total draft range

Rear draft

In three-roller double-apron draft systems with controlled slip draft of the fibre (recessed roller), it is necessary to pretension the roving at the rear zone. The roving should be guided into the double-apron unit in a well-stretched condition. Rear drafts between 1.10 and 1.25 have shown good results.

Draft fields

Total draft-field length

For the PK 1601 the maximum total draft-field length $GF_{max} = 223$ mm. The total draft-field length can be approximately determined as follows:

$$GF = \text{maximum fibre length} + \text{approx. 15 \%}$$

Front zone setting

In the case of PK 1601 weighting arm, the front zone setting (HF) is determined by the top apron cradle OH 2402 or OH 554. For the bottom roller diameters shown in fig. C, the front zone setting is always constant, amounting to 105 mm. To support apron running properties, the apron top roller is set at a backhang of 2 mm. If front zone condensers are used, the front top roller is set at 7 mm fronthead (see fig. C). A smaller fronthead may be selected, if no front zone condenser, or a special condenser is employed.

Rear zone setting

The rear zone setting (VF) basically depends on the maximum fibre length. In order to determine the rear zone setting, the standard dimension of the front zone (105 mm) must be subtracted from the total draft-field length already determined.

$$VF = GF \text{ (calculated)} - 105 \text{ mm (standard dimension)}$$

Weighting arm	max. rear zone setting	min. rear zone setting
PK 1601	118 mm	57 mm

In the case of twisted roving, a longer rear zone settings may be required. Here we recommend in-house trials to be carried out.

Draft-field widths and maximum fibre length PK 1601-0962 670

Weighting arm	Top apron cradle	Bottom roller diameter			Draft field mm			Total draft field GF mm max	Fibre length max. mm
		I	II	III	HF	VF min	VF usual ²⁾		
PK 1601-0962 670	OH 2402	35/40	27/30,5	35/40	105	57 ¹⁾	2)	223	200
	OH 554	35/40	27/30,5	35/40	105	57 ¹⁾	2)	223	200

¹⁾ Without rear zone condenser the rear zone setting reduces to 45 mm at min.

²⁾ Depends on fibre length and roving material.

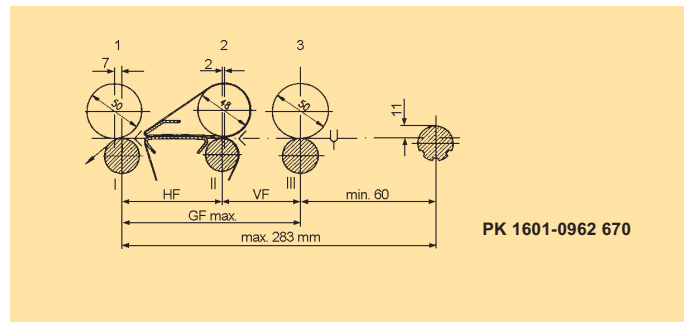

Fig. C: Draft field width and max. fibre length

Roller loading

PK 1601 weighting arm is fitted with three load stages on each weighting element (see fig. D). These are set by turning the relevant eccentric load selector. Experiences have shown that, in the case of PK 1601 weighting arm, setting the standard load (green) at the rear or front top roller is adequate for most applications. With fibre material that is difficult to draft - man-made fibres, for instance - it may be necessary to increase load to stage 3 (red). Basic load (black) is to be used for fibre material with low fibre drag. If the yarn shows thick, undrafted portions at the front pair of rollers, the next-higher load stage should be set on the front top roller. It is a feature of the system that the fibres are not nipped by the recessed apron top roller. Select the load stage which guarantees even, reliable running of top and bottom aprons. Excessive loads on the apron top roller may reduce the depth of the apron top roller recess.

Load stages of weighting elements

Colour marking of eccentric load selector	Front 1 PEL-0735 302	Middle 2 PEL-0735 303	Rear 3 PEL-0735 305
black	20 daN	9 daN	20 daN
green	27 daN	12 daN	25 daN
red	35 daN	15 daN	30 daN

Fig. D: Load stages of weighting elements

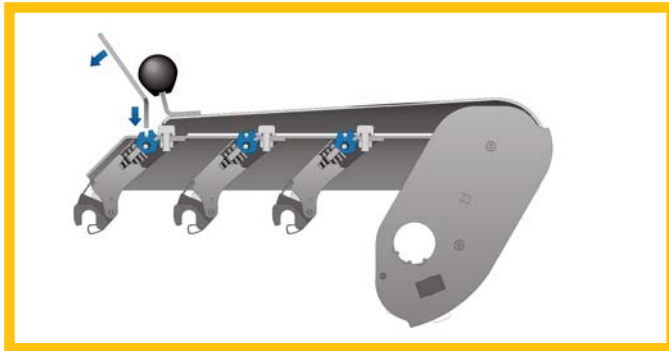

Fig. E: Load adjustment of weighting elements

Partial load relieve

PK 1601 weighting arm is equipped with a partial load relieve feature (see fig. F). Opening the lever to its first rest position activates the partial load relieve. If the ring frames hasn't been used for longer time this feature allows the front top roller to be released to the extent of a partial load relieve of approx. 5 daN. The partial load has been selected such that it reliably prevents intrusion of the yarn twist into the draft field, and even soft top roller cots are protected from permanent deformation (no moiré effect!).

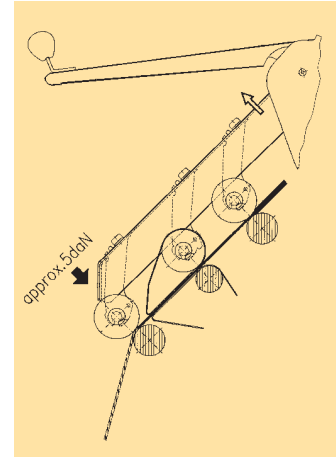

Fig. F: Partial load relieve

Top apron cradles

TEXParts PK 1601 weighting arm can be fitted with OH 2402 or OH 554 top apron cradles. For description of top apron cradles see chapter 5, page 58-61. The OH 2402 supersedes the previous cradle OH 554 and is **totally compatible** with regard to the latter one **concerning types of top rollers and colour of distance clip** (which indicates openings). Therefore, with the new cradle OH 2402 existing top rollers and distance clips from TEXParts can be used further on without any problems. For the top aprons we recommend to use PR 3217 (gauge 75 mm) and PR 4017 (gauge 82.5 mm). Existing apron sizes with designation PR 32/5 (gauge 75 mm) and PR 40/5 (gauge 82.5 mm) respectively can be used further on with the OH 2402, if the backhang of the apron top roller can be adjusted to 3 mm. Fig. G shows the top apron cradles, the appropriate top apron designations, the corresponding apron widths as well as the prescribed diameters of the apron top rollers.

Top apron cradle types	Gauge Tw [mm]	Top roller	Top apron	Basic equipm.* Distance clip	Colour
OH 2402	75	LP 1016-1256 711	PR 3217	OLC-0964 120 OLC-0004 587 OLC-0004 588	black beige green
OH 554	75	LP 1016-1256 711	PR 32/5		
OH 2402	82.5	LP 1017-1256 712	PR 4017		
OH 554	82.5	LP 1017-1256 712	PR 40/5		
OH 554	90	LP 1017-1256 713	PR 40/5		
OH 554	100	LP 1017-0013 010	PR 40/5		

* Distance clips are not included in standard OH supply.

Fig. G: Top apron cradles and distance clips for PK 1601

Opening X at apron release point

The distance between the deflecting edges of the top apron cradle and the bottom apron nose bar (= opening X) determines, with a given apron thickness, the intensity of the fibre guidance and control (fig. F). The opening X is set with the aid of special distance clips that are mounted on the top apron cradle. For differentiation and easy checking of the various openings, the distance clips are in different colours (fig. G). The opening necessary for a certain fibre material is mainly dependent on the fibre type, the fibre mass, on the kind of bottom apron nose bar and on the method and quality of the fibre preparation and the fineness of the spun yarn.

Practice has shown that, in general, three distance clips are adequate for the entire range of counts handled in worsted mills (OLC-0964 120, OLC-0004 587, OLC-0004 588). Available OLC-clips are listed in fig. I.

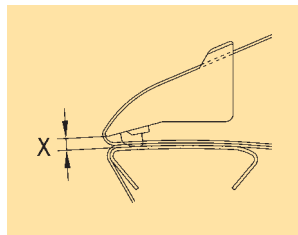

Fig. H: Opening X

Distance clip OLC Ref. No.		Opening X in [mm] with top apron cradle OH 2402
OLC-0964 120	black	2.4
OLC-0004 587	beige	3.5
OLC-0004 588	green	4.0
OLC-0004 589	pink	5.4
OLC-0964 123	blue	7.5

Fig. I: Distance clips OLC and opening X

Top roller cots

In PK 1601 weighting arm, the rear and front top rollers with newly fitted cots should have 50 mm cot diameters after first grinding. Subsequent grinding of the cots may reduce the cot diameter of rear and front top rollers by a maximum of 3 mm. Within this range the load on the top rollers remains almost constant and it is not necessary to readjust the height of the weighting arm.

The system diameter of the apron top roller is 48 mm and must be kept precisely on account of the specified apron length.

The top rollers are supplied as standard as top rollers without cot. Upon request, TEXParts will also supply top rollers with ready-ground spinning cots. Customers may specify the cot quality. The cot diameters of newly covered top rollers will be found in fig. K on the following page.

Cot grinding intervals of rear and front top rollers depend on the following:

- cot quality
- type of fibrous material
- finishing agents or other additives
- climatic conditions
- weighting pressure of top roller
- top roller running time.

In addition, to selecting the cot quality to suit the fibre, the cot should have accurately shaped edges, true, concentric running behaviour and a good-grip surface.

For the rear and front top rollers we recommend cots with a Shore hardness between 80° to 85°, and for the apron top roller cots with a Shore hardness between 75° to 80°.

In the case of recessed apron top rollers, deviating fibre characteristics may require a variety of recess depths T. Ideal values must be determined by in-house spinning tests of the spinning mill, taking the fibre masses and fibre properties into account.

Recessed rollers

The recess depth of the apron top roller has a crucial effect on the intensity of fibre guidance and fibre control. It is an important instrument for achieving optimum yarn quality. Selected recess depths that are too low can impair both yarn quality and running properties. In practice, the recess depths listed in fig. J on the following page are used.

If high loads are applied, an adequate recess depth must be assured to compensate for the flattening of the cot of the apron top roller.

Survey of dimensions of outer rings and cots

Rear and front top rollers

Top roller	d_1	d_2	b	E
LP 1014	19	50	30/32	34

Apron top roller as recessed roller

Top roller	d_1	d_2	W	b	K	T	Feed sliver count
LP 1016	19	48	32	34	18	0.5	for French-type rovings of approx. 1000 tex (Nm 1.0) and finer
LP 1017	19	48	40	40	20	1.0	for French-type rovings of approx. 1000 tex (Nm 1.0) and coarser, twisted roving approx. 1000 tex (Nm 1.0) and finer
						1.5	for twisted rovings of approx. 1000 tex (Nm 1.0) and coarser sizes, also for fibre materials with poor draft properties

d_1 = outer ring diameter of version with cot [mm]
 d_2 = diameter over cot [mm]
 b = cot width [mm]
 W = apron width [mm]
 E = width of outer ring [mm]
 T = recess depth [mm]

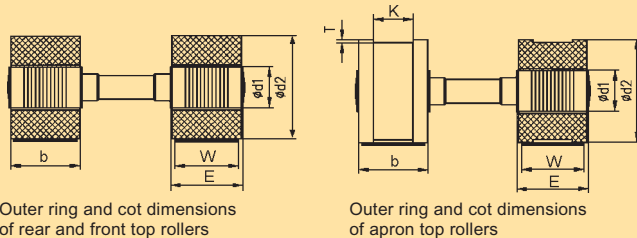

Fig. J: Top rollers with cot and outer ring dimensions for PK 1601

Bottom apron nose bar

Long bottom apron system

The bottom apron nose bar supports the bottom apron as it passes the front zone. The slightly convex shape of the nose bar provides good fibre guidance and control in the main draft zone. The height of the nose bar generally is 2.5 mm above the draft plane 1 (see fig. K). In special cases a higher nose bar position (with interchangeable washer 2) of up to approx. 4 mm may be selected. A lower nose bar position (bar on a level with draft plane) may be more favourable in the case of fibres with high fibre adhesiveness.

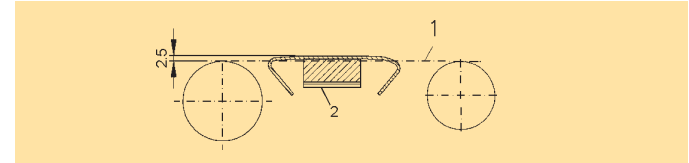

Fig. K: Draft plane with long bottom apron system

Condensers for PK 1601

Front zone condenser

The front zone condenser A is fitted in the main draft zone between the apron unit and the front pair of rollers (see fig. L). The task of the condenser is to selvedge the fibre material coming from the apron unit and prevent the flank fibres from spreading out. The front zone condenser is suspended from the guide head of the front weighting element by means of a special securing spring.

Care must be taken not to restrict the front zone condenser range of play, as this may lead to a drop in quality.

Rear zone condenser

A rear zone condenser B is employed in the draft system of worsted ring frames (see fig. L). We recommend version KL-0997 469. This condenser is positioned ahead of the apron unit. Its shape is selected in such a way that the roving is smoothed as it runs into the following double-apron unit. The rear zone condenser is coupled to the rear roving guide and copies the latter's traverse motion.

The task of the rear zone condenser is to ensure that the roving only passes through the apron roller pair within the recessed portion of the upper apron roller. The traverse motion must be adjusted in such a way that this condition can be reliably be fulfilled.

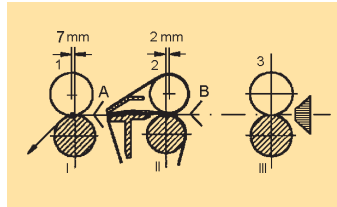

Fig. L: Fronthang of front top roller and backhang of middle top roller and arrangement of condensers

Front zone condenser Ref. No.	Gauge Tw in [mm]	Remarks	Symbol
KL-1248 233	75	Front zone condenser Pendulum secured by cheese-head screw	
KL-1248 234	82.5		
KL-1248 235	90-100		
KL-1246 243	75	Front zone condenser Pendulum with spring suspension	
KL-1246 070	82.5		
KL-1246 244	90-100		
Rear zone condenser Ref. No.			
KL-0997 469			

Fig. M: Condensers for PK 1601

Chapter 9-86

For all TEXParts draft systems survey of outer ring and cot dimensions

Rear and front top rollers

Weighting arm	Top roller	d ₁	d ₂	b	E
---------------	------------	----------------	----------------	---	---

Cotton ring frames

PK 3025	↓ LP1002 ¹⁾	19	28	25/28	30
PK 2025, PK 2055					
PK 3035	↑ LP1002 ¹⁾	19	35	25/28	30
PK 2035, PK 2065					

Cotton speed frames

PK 5000, PK 1500	↑ LP1015 ²⁾	19	28/35	40	40
PK 1600					

Worsted ring frames

PK 6000	LP 1014 ²⁾	19	50	30/32	34
PK 1601	LP 1014 ²⁾	19	50	30/32	34

¹⁾ LP 1002 series supersedes LP 302 series top rollers.

²⁾ LP 1014, LP 1015 supersedes LP 314, LP 315 series top rollers.

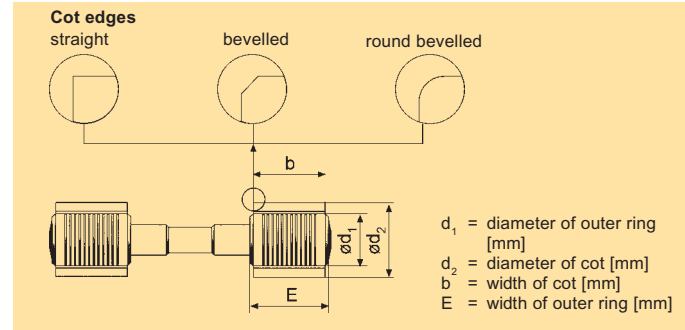

Apron top rollers

Weighting arm	Top roller	d_1	d_2	b	E	W
---------------	------------	-------	-------	---	---	---

Cotton ring frames

PK 3025, PK 3035	↑ LP 1003 ¹⁾	-	25	-	30	28/32
PK 2025, PK 2035, PK 2055, PK 2065		↓ LP 1002	19	25	30/34	30/34 28/32

Cotton speed frames

PK 1500 PK 1600	↑ LP 1017	19	25/33	40	40	40
PK 5000	LP 1015	19	25	40	40	40

Worsted ring frames

PK 6000, PK1601	LP 1016	19	48	34	34	32
	LP 1017	19	48	40	40	40

- 1) TEXParts supplies the apron top roller LP 1003 with special sleeves as standard.
If requested LP 1002 with cots can also be supplied as apron top roller.
- 2) Previous type with steel outer ring; replaced by LP 1003.

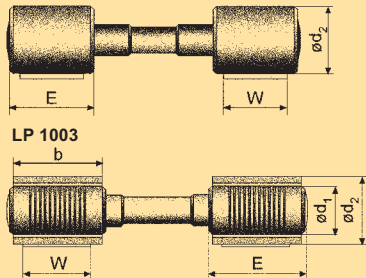

LP 1015, 1016, 1017

d_1 = diameter of outer ring [mm]
 d_2 = diameter of outer ring, sleeve or cot [mm] (see illustr.)
 b = width of cot [mm]
 E = width of outer ring or sleeve [mm]
 W = width of apron [mm]

Recessed apron top rollers

Weighting arm	Top roller	d_1	d_2	b	E	W	K	T	Feed material
---------------	------------	-------	-------	---	---	---	---	---	---------------

Worsted ring frames

PK 1601	LP 1016	19	48	34	34	32	18	↑ 0.5 1.0 1.0 1.5	French-type roving approx. Nm 1.0 or finer approx. Nm 1.0 or coarser Twisted roving approx. Nm 1.0 or finer Nm 1.0 or coarser
PK 6000	LP 1014	19	33	34	34	32	18		
PK 1601	LP 1017	19	48	40	40	40	20		
PK 6000	LP 1015	19	33	40	40	40	20		

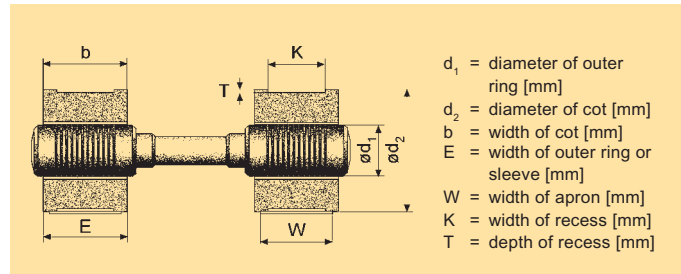

d_1 = diameter of outer ring [mm]
 d_2 = diameter of cot [mm]
 b = width of cot [mm]
 E = width of outer ring or sleeve [mm]
 W = width of apron [mm]
 K = width of recess [mm]
 T = depth of recess [mm]

Bottom roller bearings

Application

TEXParts bottom roller bearings are being installed in ring spinning frames, draw frames and speed frames. These TEXParts bearing units are fitted with precision-made needle bearings with a high-load-bearing capacity. The two lateral flanges of the inner ring have a knurled surface and provide effective protection against the intrusion of fibres.

The parted glass-fibre reinforced synthetic cage with the cage ends connected by a fitting groove ensures running characteristics like those of a solid cage.

Fixing of the outer ring in the roller stand can be carried out as standard by means of a fixing cap with either centre-guide or side lugs. TEXParts bottom roller bearings are being supplied ready-greased with TEXParts grease TG 5, or ungreased on customers' demand. Details for re-lubrication (see chapter 8, page 4).

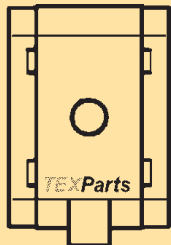

Bottom roller bearing with central guidance

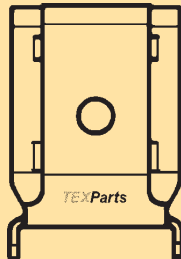

Bottom roller bearing with lateral guidance

CONVERSION*Plus* is the future-oriented TEXParts' concept for the modernization of ring spinning frames. It comprises individual modules, which can be selected and combined to fulfill the various application requirements.

In principle CONVERSION*Plus* was conceived for the modernization of the spindle and draft system areas.

The installation of a modern draft system with higher drafts and a better draft accuracy, combined with the utilization of highly efficient high speed spindles, will offer decisive advantages to the spinning mill:

- improvement of the yarn quality
- increase of spindle speed and production output
- reduction of energy consumption.

An additional advantage of the CONVERSION*Plus* principle is the fact that for the modernization of ring spinning frames no constructional changes of the existing building conditions on site are required. The machine inside of the spinning hall does not have to be moved during modernization.

With CONVERSION*Plus* machines are modernized successively, which means that there will be very little interference with the production running on other machines in the spinning hall.

Modernization of ring frames

The modernization of ring frames consists of 2 individual building blocks:

1. the modernization of the spindle sector
2. the modernization of the draft sector

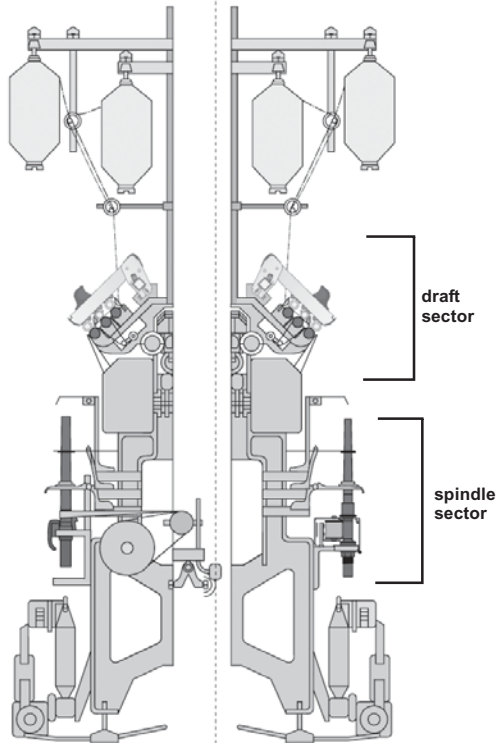

1. The modernization of the spindle sector

The employment of flexibly tensioning and adjustable spindles with small wharve diameters makes higher spindle speeds possible without increasing the rotation speed of the frame's main drive shaft (thus saving energy). The low-vibration running and excellent damping properties of TEXParts spindles also have a positive influence on the ends down rate. The installation of new, high-quality spinning rings enables the top speeds made possible by TEXParts spindles to be exploited to the full. A considerable saving in maintenance can also be achieved by the fact that these rings can be centred on the spindle.

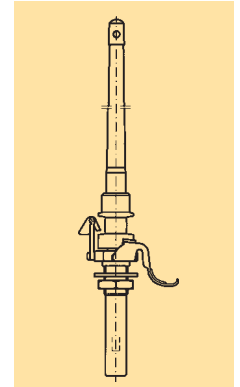

2. The modernization of the draft sector

Renewing the draft equipment within the framework of the modernization of a ring frame is of prime importance in improving yarn quality. The following options exist:

- fitting new parts to the weighting arms (i.e. exchanging top apron cradles, rear and front top rollers)
- installing new weighting arms
- renewing the fluted rollers (rear and front bottom rollers)
- replacing the knurled rollers (bottom apron rollers).

The installation of a new TEXParts draft system on double-apron basis guarantees optimal draft conditions.

After modernization the system has an ideal draft distribution and guarantees individually adjustable loading for reliable fibre guidance and nip. TEXParts draft system ensure perfect fibre control and therefore excellent yarn quality in terms of evenness strength and count variation. Another design feature of the TEXParts loading system is the precise parallel positioning of top rollers on top of the bottom rollers. TEXParts weighting arms are characterized by constant loading and minimum tolerances, thus making costly and time-consuming readjustment work unnecessary.

Textile terms, general technical term	1	British-metric units - conversion table	32
Fineness designation of fibres, yarns and strands	2	Millimeter into inches and inches into millimetres Conversion table	33
Fineness-related maximum tensile strength	3	Millimeter into inches and inches into millimetres Conversion table:	34
Fineness designation of fibres, slivers and yarns formulae for calculations	4	Inches into millimetres Conversion table:	35
Fineness designations of ply-yarns	6	Inches into millimetres Conversion table	36
Formulae for mill machine calculations	8	Introduction of international SI units	37
Additions of regain for fibres and filaments	13	Conversion of units no longer to be used	38
Further practical formulae	14		
Yarn twist	15		
Grades and Staple Length of Cottons from various Growths	16		
Spinning limits for cotton and wool	19		
Classification system for wool	20		
Traveller speeds in m/s	22		
Shapes and types of ring travellers	24		
The most usual types of ring travellers for flange rings	25		
The most usual types of ring travellers for self lubricating HZ-rings	26		
The most usual types of ring travellers for self lubricating J rings	27		
Traveller numbers for cotton spinning	28		
Humidity and temperature	29		
The h,x diagram for determining air conditioning factors	30		

tex System of Fineness Designation

The Tex unit (symbol: tex) expresses fineness in terms of mass per unit length.

$$1 \text{ tex} = \frac{1}{1000000} \frac{\text{kg}}{\text{m}} = \frac{1 \text{ g}}{1000 \text{ m}}$$

i.e., the tex fineness designation indicates the weight in grams of 1000 m of a yarn. The use of tex is not limited to yarns but includes fibres and intermediate products such as laps, slivers, tops, rovings, as well as plied yarn, strings, and braids. Where necessary the decimal multiples or sub-multiples of tex must be used. These are

$$1 \text{ millitex (mtex)} = \frac{1 \text{ mg}}{1000 \text{ m}} \text{ or}$$

$$1 \text{ decitex (dtex)} = \frac{0.1 \text{ g}}{1000 \text{ m}} = \frac{1 \text{ g}}{10000 \text{ m}} \text{ or}$$

$$1 \text{ kilotex (ktex)} = \frac{1 \text{ kg}}{1000 \text{ m}} = \frac{1 \text{ g}}{1 \text{ m}}$$

In cotton spinning (three- and four-roller spinning as well as vigogne and two-roller spinning), the coarseness (hank) of laps and slivers is expressed in kilotex (ktex) and the coarseness or fineness (count) of rovings and yarns is expressed in tex. Practical use of millitex (mtex), or decitex (dtex) respectively, is made for individual fibres only. Similar to the existing denier system, tex thus uses the **smaller** value to designate the **finer** thread (which has less weight per 1000 m), and the **bigger** value to designate the **coarser** thread (which has more weight per 1000 m).

Since "tex" is a symbol of a physical unit, it must **follow** the value indicating the fineness (count), e. g., 30 tex. This is likewise applicable to kilotex (ktex) and millitex (mtex), e. g., 5 ktex, 170 mtex.

Nm numbering system (old system of which no further use must be made).

The metric (Nm) count indicates the number of 1 km (1000 m) lengths per kg.

$$\text{Nm} = \frac{\text{length in km}}{\text{weight in kg}} \text{ or } = \frac{\text{length in m}}{\text{weight in g}}$$

Fine counts are indicated by high numbers.

Formula for determining the fineness-related maximum tensile strength of staple fibre yarns (breaking length in kilometres¹⁾ according to DIN 53 815, edition 5/1989:

$$f_H = \frac{F_H \text{ (cN)}}{T_{t_v} \text{ (tex)}}$$

where:

f_H = fineness-related maximum tensile strength²⁾ in cN/tex

F_H = maximum tensile strength in cN

T_{t_v} = initial fineness in tex

Example: $F_H = 177.2 \text{ cN}$

$$T_{t_v} = 24.6 \text{ tex}$$

$$f_H = \frac{177.2}{24.6}$$

Fibre material: pure wool,

Fibre fineness: 21 μm ,

Max. staple length approx. 145 mm

¹⁾ The designation "breaking length" calculated in kilometres and once in common use may no longer be used. We would point out that this involves no changes, as the fineness-related maximum tensile strength f_H in cN/tex gives practically identical values to those provided by the term "tenacity" in kilometres formerly employed.

²⁾ The term "tenacity" may also be used for f_H .

Fineness designation of fibres, slivers and yarns formulae for calculations

	tex	dtex	ktex	Td
tex =	-	$\frac{\text{dtex}}{10}$	ktex · 1000	$\frac{\text{Td}}{9}$
dtex =	tex · 10	-	ktex · 10 000	$\frac{\text{Td}}{0.9}$
ktex =	$\frac{\text{tex}}{1000}$	$\frac{\text{dtex}}{10\,000}$	-	$\frac{\text{Td}}{9000}$
Td =	tex · 9	dtex · 0.9	ktex · 9000	-
Nm =	$\frac{1000}{\text{tex}}$	$\frac{10\,000}{\text{dtex}}$	$\frac{1}{\text{ktex}}$	$\frac{9000}{\text{Td}}$
Ne_B = *	$\frac{590}{\text{tex}}$	$\frac{5905}{\text{dtex}}$	$\frac{0.5905}{\text{ktex}}$	$\frac{5315}{\text{Td}}$
Nf =	$\frac{500}{\text{tex}}$	$\frac{5000}{\text{dtex}}$	$\frac{0.5}{\text{ktex}}$	$\frac{4500}{\text{Td}}$
Nc =	$\frac{566}{\text{tex}}$	$\frac{5660}{\text{dtex}}$	$\frac{0.566}{\text{ktex}}$	$\frac{5094}{\text{Td}}$

Example: Nm 34 converted into tex $\text{tex} = \frac{1000}{\text{Nm}} = \frac{1000}{34} = 30$

Cotton Ne _B = $\frac{840 \text{ yds}}{1 \text{ lb}}$	Metric Conversion factor 1.69 resp. 0.59
Worsted Ne _K = $\frac{560 \text{ yds}}{1 \text{ lb}}$	Metric Conversion factor 1.13 resp. 0.89
Carded wool Ne _W = $\frac{256 \text{ yds}}{1 \text{ lb}}$	Metric Conversion factor 0.52 resp. 1.92
Conversion of roving slivers:	g/m · 14.11 = grains/yard grains/yard · 0.071 = g/m

Nm	Ne _B *	Nf	Nc	
$\frac{1000}{\text{Nm}}$	$\frac{590}{\text{Ne}_B}$	$\frac{500}{\text{Nf}}$	$\frac{566}{\text{Nc}}$	= tex
$\frac{10\,000}{\text{Nm}}$	$\frac{5905}{\text{Ne}_B}$	$\frac{5000}{\text{Nf}}$	$\frac{5660}{\text{Nc}}$	= dtex
$\frac{1}{\text{Nm}}$	$\frac{0.5905}{\text{Ne}_B}$	$\frac{0.5}{\text{Nf}}$	$\frac{0.566}{\text{Nc}}$	= ktex
$\frac{9000}{\text{Nm}}$	$\frac{5315}{\text{Ne}_B}$	$\frac{4500}{\text{Nf}}$	$\frac{5094}{\text{Nc}}$	= Td
-	Ne _B · 1.6934	Nf · 2.0	$\frac{\text{Nc}}{0.566}$	= Nm
Nm · 0.5905	-	Nf · 1.181	$\frac{\text{Nc}}{0.9584}$	= Ne _B
Nm · 0.5	Ne _B · 0.8467	-	$\frac{\text{Nc}}{1.132}$	= Nf
Nm · 0.566	Ne _B · 0.9584	Nf · 1.132	-	= Nc

* Ne_B column includes some rounded-off values

Examples: Ne_B 20 · 1.69 = Nm 34
Nm 34 · 0.59 = Ne_B 20
Ne_K 53 · 1.13 = Nm 60
Nm 60 · 0.89 = Ne_K 53
Ne_W 0.8 · 0.52 = Nm 0.4
Nm 0.4 · 1.92 = Ne_W 0.8

Fineness designations of ply-yarns

Doubled yarn with identical strands

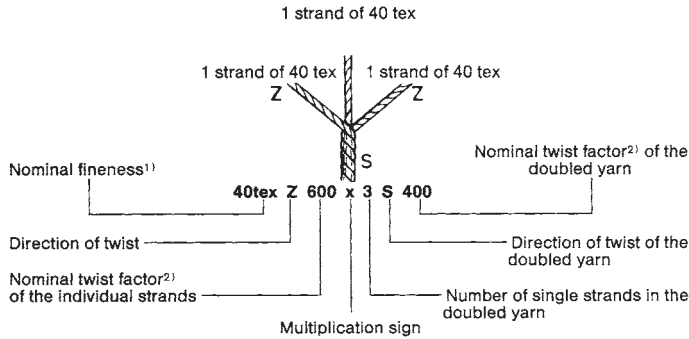

Doubled yarn made of different threads

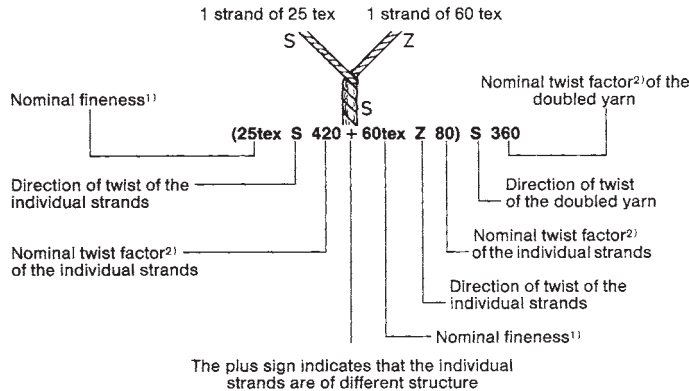

Cabled yarn composed of identical initial twists

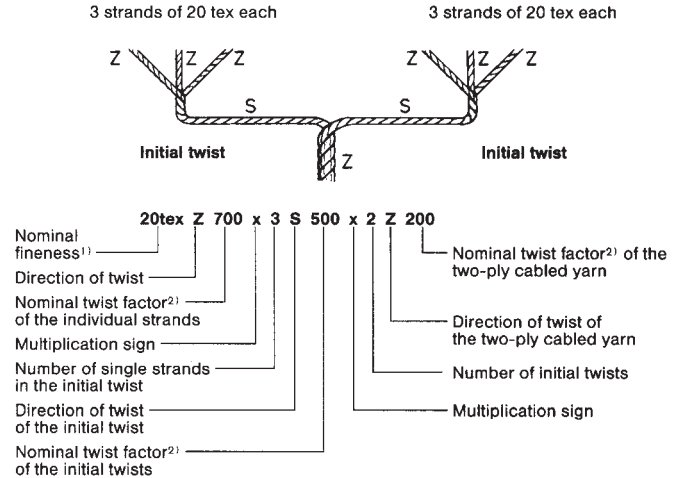

¹⁾ Normal commercial designation of a yarn or twist.

²⁾ Nominal twist factor = number of twists per metre prescribed for the manufacture of a yarn or twist.

Note: details of structure, twist factor and direction of twist may be omitted if not required.

Formulae¹⁾ for mill machine calculations

Cards

Draft: Calculation as shown for speed frames
usual drafts: 80-100-110-120

$$\text{Cardings/cm} = \frac{nT}{V_{sp}} = \frac{\text{carding constant}}{A_w \cdot N_w}$$

where: nT = rev/min cylinder
 V_{sp} = feed roller speed in cm/min
 A_w = dia. doffer change gear
 N_w = dia. draft change gear

$$\text{Production: } P_{pr} = \frac{k_{tex} \cdot L \cdot m/\min \cdot 60}{1 \cdot 1000} \cdot \eta \quad L \cdot m/\min = \frac{\pi \cdot d \cdot n}{1000}$$

$$P_{pr} = \frac{60 \cdot \pi \cdot d \cdot n}{N_m \cdot 1000 \cdot 1000} \cdot \eta \quad P_{pr} = \frac{LK \cdot AW}{N_m} \cdot \eta$$

where: P_{pr} = practical production in kg/hr/mach
 L = delivery in m/min
 d = dia. of coiler or calender rollers in mm
 n = rev./min of coiler or calender rollers
 η = efficiency
 LK = delivery constant
 AW = dia. doffer change gear
 N_m = count (metric)

Draw frames

Draft: Calculation as shown for speed frames

$$\text{Production: } P_{pr} = \frac{k_{tex} \cdot L \cdot m/\min \cdot 60}{1 \cdot 1000} \cdot \eta \quad L \cdot m/\min = \frac{\pi \cdot d \cdot n}{1000}$$

$$P_{pr} = \frac{60 \cdot \pi \cdot d \cdot n}{N_m \cdot 1000 \cdot 1000} \cdot \eta$$

¹⁾ The formulae shown in squares are based on the tex unit of fineness.

where:

P_{pr} = practical production in kg/hr/delivery
 L = delivery in m/min
 d = dia. of front bottom roller in mm
 n = rev/min of front bottom roller
 η = efficiency

Calculating fineness in ktex:

$$k_{tex} = \frac{k_{tex}' \cdot d}{v} \cdot \left(\frac{100-p}{100} \right)$$

Calculating Nm yarn count:

$$N_m = N_m' \cdot \frac{v}{d} \cdot \left(\frac{100}{100-p} \right)$$

where:
 k_{tex} = fineness of material delivered
 k_{tex}' = fineness of feed material
 N_m = count delivered
 N_m' = count fed
 v = draft
 d = doublings
 p = waste percentage

Speed frames

Draft:

$$\text{Draft} = \frac{\text{fineness of feed material}}{\text{fineness of delivered material}} = \frac{k_{tex}'}{k_{tex}}$$

$$N_{w1} = N_w \cdot \frac{k_{tex}' \cdot k_{tex}_1}{k_{tex} \cdot k_{tex}_1'}$$

$$\text{Draft} = \frac{\text{count delivered}}{\text{count fed}} = \frac{\text{draft constant}}{\text{dia. draft change gear}}$$

$$N_{w1} = N_w \cdot \frac{N \cdot N_1'}{N' \cdot N_1}$$

where:	present	new
change gear	N_w	N_{w1}
delivered	k_{tex}	k_{tex}_1
fed	k_{tex}'	k_{tex}_1'
delivered	N	N_1
fed	N'	N_1'

Building motion:

$$S_1 = S \cdot \sqrt{\frac{k_{tex}}{k_{tex}_1}}$$

$$S_1 = S \cdot \frac{\sqrt{N_1}}{\sqrt{N}}$$

where:	present	new
ratchet wheel	S	S_1
fineness	k_{tex}	k_{tex}_1
count	N	N_1

Twist:

$$T/m = \frac{\alpha k t e x}{\sqrt{k t e x}} = \frac{\text{twist constant}}{\text{twist change gear (driving)}} = \frac{n s p i}{L}$$

$$D w_1 = \frac{D w \cdot \sqrt{\frac{k t e x_1}{k t e x}} \cdot \alpha}{\alpha_1}$$

$$T = \alpha \cdot \sqrt{N m} = \frac{\text{twist constant}}{\text{twist change gear (driving)}} = \frac{n s p i}{L}$$

$$D w_1 = \frac{D w \cdot \sqrt{N} \cdot \alpha}{\sqrt{N_1} \cdot \alpha_1}$$

where:

fineness	present	new
twist multiplier	α	α ₁
twist change gear	Dw	Dw ₁
nspi = rev/min of spindle		
L = delivery of front bottom roller in m/min		
count	N	N ₁

Production:

$$P p r = \frac{k t e x \cdot L \cdot m / \min \cdot 60}{1 \cdot 1000} \cdot \eta$$
 or

$$P p r = \frac{60 \cdot G}{x \cdot \frac{1000 \cdot G \cdot T}{k t e x \cdot n s p i} + t a} \cdot \eta$$

$$P p r = \frac{n s p i \cdot 60}{T \cdot N \cdot 1000} \cdot \eta$$

where:

Ppr = practical production in kg/hr/spindle	T = turns per metre
L = delivery in m/min	nspi = rev/min of spindle
η = efficiency	G = bobbin nett weight in grams
N = metric count	x = disturbance factor (1.05–1.2)
	ta = minutes per doff

Ring frames

Draft:

$$\text{Draft} = \frac{\text{tex}'}{\text{tex}}$$

See also draft calculation for speed frames

Twist:

$$T/m = \frac{\alpha \text{ tex}}{\sqrt{\text{tex}}} = \frac{n s p i}{L}$$

Delivery:

$$L = \frac{n s p i}{T/m}$$

where:

T/m = turns per metre
L = delivery in m/min
nspi = rev/min of spindle

See also twist calculation for speed frames

Building motion:

$$S_1 = S \cdot \frac{\text{tex}}{\text{tex}_1} \qquad S_1 = S \cdot \frac{N_1}{N}$$

where:

ratchet wheel	present	new
fineness	S	S ₁
count	dtex	dtex ₁
	N	N ₁

Production:

$$P p r = \frac{\text{tex} \cdot L \cdot 60}{1000} \cdot \eta$$
 or

$$P p r = \frac{\text{tex} \cdot n s p i \cdot 60}{T \cdot 1000} \cdot \eta$$

$$P p r = \frac{n s p i \cdot 60}{T \cdot N} \cdot \eta$$

where:

Ppr = practical production in g/hr/spindle
L = delivery in m/min
N = metric count
T = turns per metre
nspi = rev/min of spindle
η = efficiency (empirical values for η = 0.82–0.96; good results are η = 0.88 with manual doff, and η = 0.93 with automatic doff)

Rotor spinning

Draft:
$$\text{Draft} = \frac{\text{tex}'}{\text{tex}}$$

$$\text{Draft} = \frac{\text{feed fineness}}{\text{delivery fineness}}$$

$$\text{Draft} = \frac{\text{count delivered}}{\text{count fed}} = \frac{N}{N'}$$

tex' = feed fineness N = count delivered, e.g. Nm
 tex = delivery fineness N' = count fed, e.g. Nm

Twist:
$$T/m = \frac{\alpha \text{ tex}}{\sqrt{\text{tex}}} = \frac{nR}{L}$$

where:

T/m = turns per metre
 L = delivery in m/min
 nR = rev/min of rotor

Production:
$$\text{Ppr} = \frac{\text{tex} \cdot L \cdot 60}{1000} \cdot \eta$$
 or
$$\text{Ppr} = \frac{\text{tex} \cdot nR \cdot 60}{T \cdot 1000} \cdot \eta$$

$$\text{Ppr} = \frac{nR \cdot 60}{T \cdot N} \cdot \eta$$

where :

Ppr = practical production in g/hr/spinning position

L = delivery in m/min

N = metric count

T = turns per metre

nR = rev/min of rotor

η = efficiency (empirical values for $\eta = 0.92-0.97$)

Additions of regain for fibres and filaments¹⁾

Kind of fibre	Regain percentage	Kind of fibre	Regain percentage
Wool and hair:		Fluoric	0.00
combed fibre	18.25	Modacrylic	2.00
carded fibre	17.00	Polyamide (6.6):	
Hair:		fibre	6.25
combed fibre	18.25	filament	5.75
carded fibre	17.00	Polyamide 6:	
Tail and mane hair:		fibre	6.25
combed fibre	16.00	filament	5.75
carded fibre	15.00		
Silk	11.00	Polyester:	
		fibre	1.00
Cotton	8.50	filament	1.50
mercerized fibre	10.50		
Kapok	10.90	Polyethylene	1.50
Flax or linen	12.00	Polypropylene	2.00
Hemp	12.00	Polyurea	2.00
Jute	17.00	Polyurethane:	
Manila	14.00	fibre	3.50
Alfa	14.00	filament	3.00
Coir	13.00		
Broom	14.00	Vinylal	5.00
Kenaf	17.00	Trivinyl	3.00
Ramie (degreased fibre)	8.50	Elastodien	1.00
Sisal	14.00	Elasthane	1.50
Acetate	9.00	Glass:	
Alginate	20.00	(filament above	
Cupro	13.00	5 microns)	2.00
Modal	13.00	(filament of or	
Regenerated protein-base fibre	17.00	below 5 microns)	3.00
Triacetate	7.00	Metal	2.00
Viscose	13.00	Metallized fibre	2.00
Polyacrylic	2.00	Asbestos	2.00
Polychloride	2.00	Paper yarn	13.75

¹⁾ These are the regains specified in the EC Textile Identification Bill for calculating the fibre weights in textiles.

Further practical formulae

Draft:
$$\text{Draft } V = \frac{v_A}{v_Z}$$

$$v_A = \text{speed of stripping roller}$$
in m/min or cm/min

$$v_Z = \text{speed of feed roller}$$
in m/min or cm/min
Example: Calculate the draft between the stripping roller and the feed roller on a card

$$V = \frac{12.5 \text{ m/min}}{0.54 \text{ m/min}} = 23.1$$

$$v_A \text{ (stripping roller)} = 12.5 \text{ m/min}$$

$$v_S \text{ (feed roller)} = 0.54 \text{ m/min}$$

Total draft: The total draft of a drafting system is the **product** of the partial drafts being used.

$$V_G = V_1 \cdot V_2 \cdot \dots \cdot V_n$$

Example:

$$V_G = 25 \cdot 1.5$$

$$V_G = 37.5$$

$$V_1 = \text{front zone draft} = 25$$

$$V_2 = \text{rear zone draft} = 1.5$$

Yield percentage calculation:

$$p = \frac{b \cdot 100 \%}{a}$$

p = yield percentage

b = yield in kg

a = initial quantity in kg

Example:

Initial quantity of cotton for opening is a = 1200 kg, final quantity of yarn is b = 1130 kg. Calculate yield percentage.

$$p = \frac{1130 \text{ kg} \cdot 100 \%}{1200 \text{ kg}} = 94.2 \% \text{ yield}$$

Unevenness index I according to Martindale:

$$i = \frac{Cv_{\text{eff}}}{Cv_{\text{lim}}}$$

Cv_{eff} = measured yarn unevenness

Cv_{lim} = limit of unevenness

Limit of unevenness:

$$Cv_{\text{lim}} = \frac{100}{\sqrt{n}}$$

n = average number of fibres

T_l = Yarn liter

$$n = \frac{T_{lG}}{T_{lF}}$$

T_{lG} = Yarn count in tex

T_{lF} = Fibre count in tex

Average number of fibres:

$$n = \frac{Nm_F}{Nm_G}$$

Nm_F = fibre count

Nm_G = yarn count

Yarn twist

Twist calculation according to DIN 53 832 – Part 2 (draft)

T = torsion (Latin) = twist

T/m = turns per metre

α = twist multiplier

Formula 1 (tex-System):

$$T/m = \alpha \cdot \sqrt{\frac{1000}{T_l}}$$

Formula 2 (Nm-System):

$$T/m = \alpha \sqrt{Nm}$$

Formula 3 (Neß-System): $T/m = \alpha e \cdot \sqrt{Neß}$

α = varies with the count spun even if similar materials are processed with the same degree of twist. As tenacity becomes less with greater yarn fineness, it is necessary for the twist multiplier to be increased in spinning finer counts.

Explanations:

α = tex system and Nm-system twist multiplier

αe = English twist multiplier

αm = metric twist multiplier

T/m = turns per inch

T/m = turns per metre

tex = tex designation of fineness

Neß = English cotton count

Nm = metric count

For conversion of the values:

$\alpha_{\text{tex}} = \alpha m \cdot 100$

$T/m = T/m \cdot 0.0254$

$T/m = T/m \cdot 39.37$

	given	α	αe
wanted			
$\alpha =$		-	$\alpha e \cdot 30,3$
$\alpha e =$		$\alpha \cdot 0.033$	-

Grades and Staple Length of Cottons from various Growths

<u>USA</u>	White	Light spotted	Spotted	Tinged	Yellow Stained
GOOD MIDDLING	11*	12	13		
STRICT MIDDLING	21*	22	23*	24	25
MIDDLING	31*	32	33*	34*	35
STRICT LOW MIDDLING	41*	42	43*	44*	
LOW MIDDLING	51*	52	53*	54*	
STRICT GOOD ORDINARY	61*	62	63*		
GOOD ORDINARY	71*				
BELOW GRADE	81	82	83	84	85

*physical Standards, all others on description

Growing areas:

Southeast: Alabama, Florida, Georgia, North Carolina, South Carolina, Virginia
About 10% of the US crop, mainly for local consumption.
Average staple length 1.1/16 inch

Mid-South: Arkansas, Louisiana, Mississippi, Missouri, Tennessee
About 35% of total production, main share for local consumption. Average staple length over 1.1/16".

Southwest: Kansas, Oklahoma, Texas
About 30% of total production whereof ample 50% are exported. Average staple length below 1.1/16".

West: Arizona, California, New Mexico
About 25% of total production, mainly for export.
Average staple length over 1.1/8".

American Pima is grown in Arizona, California, New Mexico, Texas and Mississippi. Length: 1.3/8" - 1.1/2", Micronaire 3.5-4.9, strength 36-38 g/tex.

SUDAN

Extra Long Staple:	BARAKAT 1.3/8" - 1.9/16" Gezira and Tokar region
Medium to Long Staple:	SHAMBAT (B) 1.1/4" - 1.3/8" Gezira region
Medium Staple:	Acala 1.1/32" - 1.1/8" Gezira, Rahad, Girba and White Nile region
Short Staple:	Nuba Mountains 1" - 1.1/16"

Central Asia (Uzbekistan, Turkmenia, Azerbaijan, Kazakhstan, Kirghizstan)

Uzbekistan Standards:

BIRINCHI	(1st Sort.)	OLIY	YAKSHI	URTA	ODDIY	IFLOS
IKINCHI	(2nd Sort.)	OLIY	YAKSHI	URTA	ODDIY	IFLOS
UCHINCHI	(3rd Sort.)		YAKSHI	URTA	ODDIY	IFLOS
TURTINCHI	(4th Sort.)		YAKSHI	URTA	ODDIY	IFLOS
BESHINCHI	(5th Sort.)			URTA	ODDIY	IFLOS

The sorts are subdivided into classes according to trash content: (OLIY [highest] = lowest trash content, IFLOS [leafy] = highest trash content). Staple length for upland styles: 1.1/32" - 1.5/32"; Extra Long Staple upto 1.7/16".

TURKMENIA

Standards 1 to 6 comparable with old USSR standards (Pervyi, Vtoroi etc.).
Staple length: 1.1/16" - 1.5/32" and Extra Long Staple up to 1.7/16".

EGYPT

Extra Long Staple Varieties:

GIZA 45	(1.13/32" - 1.7/16")
GIZA 46	(1.3/8" - 1.7/16")
GIZA 70	(1.3/8" - 1.7/16")
GIZA 77	(1.11/32" - 1.3/8"),
GIZA 84	

Long Staple Varieties:

GIZA 75	(1.3/16" - 1.1/4")
DANDARA	(1.5/32" - 1.7/32")
GIZA 80	(1.3/16" - 1.1/4")
GIZA 85	(1.3/15" - 1.7/32")
GIZA 83	(1.5/32" - 1.1/4")
GIZA 81	

The above varieties are exported to practically the whole world, with the exception of GIZA 80, DANDARA, GIZA 85, and GIZA 83 which are reserved for local consumption. Egyptian cotton is sold on basis of private types and it is completely forbidden to sell on specification like other growths. Grades from EXTRA down to FAIR, standards deposited in Alexandria.

PARAGUAY

Grado 1 to Grado 7 grades comparable with US, partly slightly spotted. Staple length: 1.3/32" - 1.5/32".

Spinning limits for cotton and wool

PERU

Tanguis	staple 1.1/8" to 1.3/16"	Micronaire 5.2 - 5.8
PIMA	staple 1.1/2" to 1.5/ 8"	Micronaire 3.3 - 3.9
Del Cerro	staple 1.5/16" to 1.7/16"	Micronaire 3.3 - 3.8
Aspero	staple 1.1/32" to 1.3/32"	Micronaire 6.3 - 6.9

Ivory Coast

Traded on private types; grades comparable with US; colour: silky bloomy yellowish to light spotted. Staple length: 1.1/16" to 1.5/32".

Conversion Table of Staple lengths

Inch	mm (mathematical value)	mm (GOST specification)
7/ 8"	22.23	24/25
29/32"	23.02	25/26
15/16"	23.81	26/27
31/32"	24.61	27.28
1"	25.40	28/29
1 1/32"	26.19	30/31
1 1/16"	26.99	31/32
1 3/32"	27.78	32/33
1 1/ 8"	28.58	33/34
1 5/32"	29.37	34/35
1 3/16"	30.16	35/36
1 7/32"	30.96	36/37
1 1/ 4"	31.75	36/37
1 9/32"	32.54	37/38
1 5/16"	33.34	38/39
1 3/ 8"	34.93	39/40
1 7/16"	36.51	40/41
1 1/ 2"	38.10	41/42

Published with kind permission of the "Bremen Cotton Exchange". We would like to thank Mr. Neumann of the "Bremen Cotton Exchange" for his kind assistance.

Cotton		Fibre fineness dtex	approx. spinning limit		
Staple length			tex	Nm	Ne
mm	Inches				
↑ ↓ ↑ ↓	↑ ↓ ↑ ↓	2.56	40	25	15
		2.38	33	30	18
		2.22	29	35	21
		2.15	25	40	24
		2.10	22	45	27
		2.00	20	50	30
		1.88	17	60	35
		1.76	14	70	41
		1.55	13	80	47
		1.50	11	90	53
↑ ↓	↑ ↓	1.46	10	100	59
		1.36	7	150	89
		1.22	5	200	118
Wool	Fineness designation	Fibre-∅ in µm	Fibre Fineness dtex	Spinning limit tex (Nm)	Number of fibres q
Merinos	AAA	17.5	2.8	10 (96)	35.7
	AA	19.2	3.5	13 (78)	37.1
	A/AA	20.0	4.1	15 (64)	36.6
	A	21.0	4.6	19 (52)	41.3
	A/B	22.5	5.3	23 (44)	43.4
	B	23.5	5.5	25 (40)	45.5
Crossbreds	A/B	24.0	5.8	26 (38)	44.8
	B	25.0	6.3	28 (36)	44.4
	CI	26.5	7.2	32 (32)	44.4
	CII	28.5	8.3	36 (28)	43.4
	DI	31.0	9.9	42 (24)	41.8
	DII	32.0	10.5	46 (22)	42.4
	E	35.0	12.7	64 (16)	50.4
	EE	38.0	16.0	125 (8)	78.1

Classification system for wool

Display on Rapid lanometer in μ	10	15	20	25	30	35	40	45	50	55	60																									
\bar{X} individual fibre θ in μ from N = 100 fibres	15	20	25	30	35	40	45																													
Fineness according to Schneider	1	2	3	4	5	6	7	8	9	10	11	12	13	14	15	16	17	18	19	20	21	22	23	24	25											
English classification	100's		90's		80's		70's		66's		64's		60's		58's		56's		50's		48's		46's		44's		40's		36's							
Australian classification	Combing				Clothing				Low Crossed				dito				Southdo Crossed				Romney Marsh															
American classification	Fine						$\frac{1}{2}$ Blood						$\frac{3}{8}$ Blood						$\frac{1}{4}$ Blood						Common						Braid					
French classification	150	140	130	120	110	105																														
French classification	I	II	III	IV	V	VI	VII	VIII	IX	X	XI	XII	XIII																							
German classification	AAAA		AAA		AA		A		B		C'		C ^{II}		D ^I		D ^{II}		E		EE															
Classification according to Müller	Sup. Elek AAA		Elekta AA		Prima A		Sekunda B		Tertia C		Quarta D																									

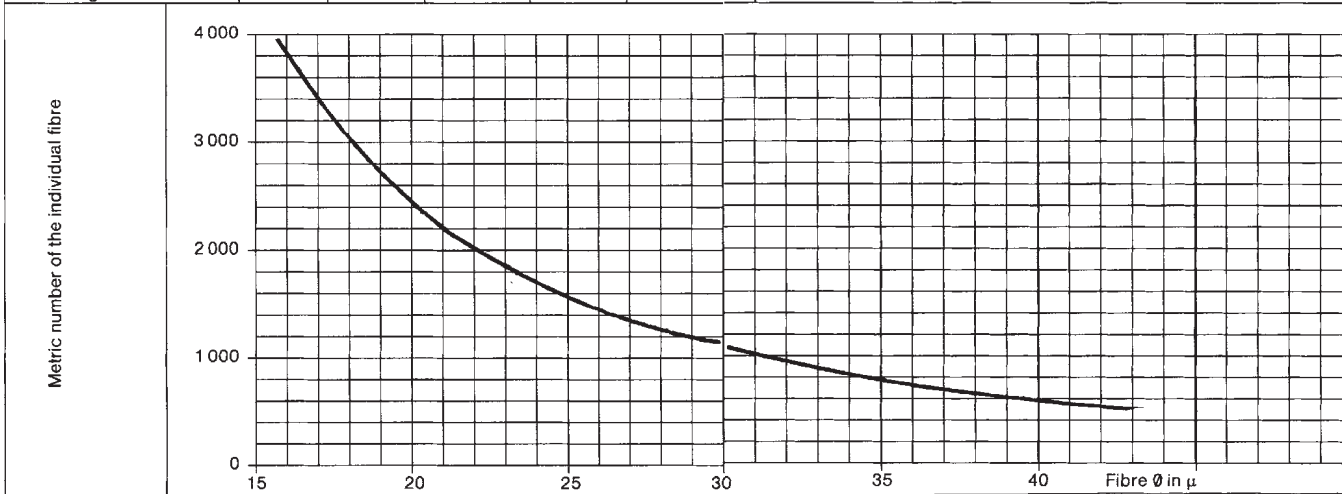

Traveller speeds in m/s

Ring- ϕ mm	inch (ca.)	Spindle speeds in 1000 rpm																									Ring- ϕ m inch														
		Spindle speeds in 1000 rpm												Spindle speeds in 1000 rpm																											
		Traveller speeds m/s												Traveller speeds in m/s																											
		11.5	12.0	12.5	13.0	13.5	14.0	14.5	15.0	15.5	16.0	16.5	17.0	17.5	18.0	18.5	19.0	19.5	20.0	20.5	21.0	21.5	22.0	22.5	23.0	23.5			24.0	24.5	25.0										
36	1 1/16	21.7	22.6	23.6	24.5	25.5	26.4	27.3	28.3	29.2	30.2	31.1	32.0	33.0	33.9	34.9	35.8	36.8	37.7	38.6	39.6	40.5	41.5	42.4	43.4	44.3	45.2	46.2	47.1	36	1 1/16										
38	1 1/2	22.9	23.9	24.9	25.9	26.9	27.9	28.9	29.9	30.8	31.8	32.8	33.8	34.8	35.8	36.8	37.8	38.8	39.8	40.8	41.8	42.8	43.8	44.8	45.8	46.8	47.8	48.8	49.7	38	1 1/2										
40	1 9/16	24.1	25.1	26.2	27.2	28.3	29.3	30.4	31.4	32.5	33.5	34.6	35.6	36.7	37.7	38.8	39.8	40.8	41.9	42.9	44.0	45.0	46.1	47.1	48.2	49.2	50.3	51.3	52.4	40	1 9/16										
42	1 5/8	25.3	26.4	27.5	28.6	29.7	30.8	31.9	33.0	34.1	35.2	36.3	37.4	38.5	39.6	40.7	41.8	42.9	44.0	45.1	46.2	47.3	48.4	49.5	50.6	51.7	52.8	53.9	55.0	42	1 5/8										
45	1 3/4	27.1	28.3	29.5	30.6	31.8	33.0	34.7	35.3	36.5	37.7	38.9	40.1	41.2	42.4	43.6	44.8	46.0	47.1	48.3	49.5	50.7	51.8	53.0	54.2	55.4	56.6	57.7	58.9	45	1 3/4										
48	1 7/8	28.9	30.2	31.4	32.7	33.9	35.2	36.4	37.7	39.0	40.2	41.5	42.7	44.0	45.2	46.5	47.8	49.0	50.3	51.5	52.8	54.0	55.3	56.6	57.8	59.1	22.0	23.1	24.2	42	1 7/8										
50	2	30.1	31.4	32.7	34.0	35.3	36.7	38.0	39.3	40.6	41.9	43.2	44.5	45.8	47.1	48.4	49.7	51.1	52.4	53.7	16.5	17.7	18.9	20.0	21.2	22.4	23.6	24.7	25.9	45	1 3/4										
52	2 1/16	31.3	32.7	34.0	35.4	36.8	38.1	39.5	40.8	42.2	43.6	44.9	46.3	47.7	49.0	50.4	51.7	53.1	15.1	16.3	17.6	18.9	20.1	21.4	22.6	23.9	25.1	26.4	27.6	48	1 7/8										
55	2 1/8	33.1	34.6	36.0	37.4	38.9	40.3	41.8	43.2	44.6	46.1	47.5	49.0	50.4	51.8	53.3			15.7	17.0	18.3	19.7	20.9	22.3	23.5	24.9	26.2	27.5	28.8	50	2										
57	2 1/4	34.3	35.8	37.3	38.8	40.3	41.8	43.3	44.8	46.3	47.8	49.3	50.7	52.2					16.3	17.7	19.1	20.4	21.8	23.1	24.5	25.9	27.2	28.6	30.0	52	2 1/16										
60	2 3/8	36.1	37.7	39.3	40.8	42.4	44.0	45.6	47.1	48.7	50.3	51.8							17.3	18.7	20.2	21.6	23.0	24.5	25.9	27.4	28.8	30.2	31.7	55	2 1/8										
63	2 1/2	37.9	39.6	41.2	42.9	44.5	46.2	47.8	49.5	51.1									16.4	17.9	19.4	20.9	22.4	23.9	25.4	26.9	28.4	29.8	31.3	32.8	57	2 1/4									
65	2 5/8	39.1	40.8	42.5	44.2	46.0	47.7	49.4											15.7	17.3	18.9	20.4	22.0	23.6	25.1	26.7	28.3	29.8	31.4	33.0	34.6	60	2 3/8								
70	2 3/4	42.2	44.0	45.8	47.7	49.5														14.8	16.5	18.1	19.8	21.4	23.1	24.7	26.4	28.0	29.7	31.3	33.0	34.6	63	2 1/2							
75	3	45.2	47.1	49.1															13.6	15.3	17.0	18.7	20.4	22.1	23.8	25.5	27.2	28.9	30.6	32.3	34.0	35.7	37.4	65	2 3/4						
80	3 1/8	48.2																	12.8	14.7	16.5	18.3	20.2	22.0	23.8	25.7	27.5	29.3	31.2	33.0	34.8	36.7	38.5	40.3	70	3					
75	3															11.8	13.7	15.7	17.7	19.6	21.6	23.6	25.5	27.5	29.5	31.4	33.4	35.3	37.3	39.3	41.2	43.2	75	3							
80	3 1/8																			11.7	12.6	14.7	16.8	18.9	20.9	23.0	25.1	27.2	29.3	31.4	33.5	35.6	37.7	39.8	41.9	44.0	46.1	80	3 1/8		
90	3 1/2																				12.3	13.2	14.1	16.5	18.9	21.2	23.6	25.9	28.3	30.6	33.0	35.3	37.7	40.1	42.4	44.8	47.1	90	3 1/2		
100	4																				12.6	13.6	14.7	15.7	18.3	20.9	23.6	26.2	28.8	31.4	34.0	36.7	39.3	41.9	44.5	47.1	49.7	52.4	100	4	
115	4 1/2																				13.2	14.5	15.7	16.9	18.1	21.1	24.1	27.1	30.1	33.1	36.1	39.1	42.2	45.2	48.2	51.2	54.2	57.2	115	4 1/2	
120	4 3/4																					12.6	13.8	15.1	16.3	17.6	18.9	22.0	25.1	28.3	31.4	34.6	37.7	40.8	44.0	47.1	50.3	53.4	56.6	120	4 3/4
140	5 1/2																					13.2	14.7	16.1	17.6	19.1	20.5	22.0	25.7	29.3	33.0	36.7	40.3	44.0	47.7	51.3	55.0	58.7	140	5 1/2	
160	6 1/4																						13.4	15.1	16.8	18.4	20.1	21.8	23.5	25.1	29.3	33.5	37.7	41.9	46.1	50.3	54.5	58.7	62.8	160	6 1/4
180	7 1/8																						13.2	15.1	17.0	18.9	20.7	22.6	24.5	26.4	28.3	33.0	37.7	42.4	47.1	51.8	56.6	61.3	66.0	180	7 1/8
200	7 7/8																						14.7	16.8	18.9	20.9	23.0	25.1	27.2	29.3	31.4	36.7	41.9	47.1	52.4	57.6	62.8	200	7 7/8		
225	8 7/8																						14.7	16.8	18.9	21.2	23.6	25.9	28.3	30.6	33.0	35.3	41.2	47.1	53.0	58.9	64.8		225	8 7/8	
250	9 7/8	10.5	13.1	15.7	18.3	20.9	23.6	26.2	28.8	31.4	34.0	36.7	39.3	45.8	52.4	58.9	65.5																						250	9 7/8	
275	10 7/8	11.5	14.4	17.3	20.2	23.0	25.9	28.8	31.7	34.6	37.4	40.3	43.2	50.4	57.6																								275	10 7/8	
300	11 7/8	12.6	15.7	18.9	22.0	25.1	28.3	31.4	34.6	37.7	40.8	44.0	47.1	55.0																									300	11 7/8	
350	14	14.7	18.3	22.0	25.7	29.3	33.0	36.7	40.3	44.0	47.7	51.3	55.0																										350	14	

Spindle speeds in 1000 rpm

Spindle speeds in 1000 rpm

Shapes and types of ring travellers

To process the wide range of yarn qualities or to suit the various traveller speeds, a variety of traveller types are employed, e.g.

Traveller shape	Flange No.	Wire profile	Traveller No. type	ISO No. (mg per pc.)	Surface treatment
EL	1	hf	10/0	20	SUPER-SPEED
EL	1	hd	EM	4/0	CERA-DUR
C	1	hr	TW	1/0	BLACK-SPEED
C	1	hf	KM	6/0KN	SUPER-SPEED
C	2	hd	TM	2	CERA-NIT
C	2	rf	MT	6	SUPER-SPEED

Some traveller shapes are manufactured in the following wire profiles:

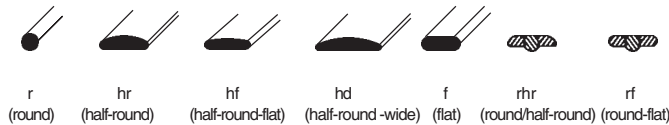

The various shapes are required to achieve uniform yarn quality with every type of yarn, or to enable spinning to be done at maximum speeds. Travellers made of **round wire** (r) are preferred where long-staple and sensitive synthetic yarns require travellers that permit particularly smooth yarn travel. Travellers made of **half-round wire** (hr, hd, hf) are preferred for processing short-staple yarns at top speeds. **Flat wire travellers** (f) are used when yarns of minimum hairiness are required, e.g. in the case of combed cotton. **Round / flat wire travellers** (rf, rhr) have round wire at the point where the thread runs through the traveller and are flat on the ring-frame side. They are used for pure synthetics, particularly acrylic fibres. Traveller shapes deviating from the standard type of C or EL travellers are given descriptive additional designations such as:

T = low shape (e.g. C 2 hr Type -T) H = high shape (e.g. EL 2 hr Type -H)
 MT = medium low shape (e.g. C 2 f Type -MT) W = wide shape (e.g. EL 1 hd Type -W)









Combinations of additional designations can occur, such as:
 Type -HW- = high and wide shape (e.g. EL 1 hr Type -HW-)
 Type -EMT- = narrow and medium-deep shape (e.g. C 1 hr Type -EMT-)

Shape	Traveller Designation									Ring Flange (to DIN ISO 96)			
	Shape	Type	Wire Profile						No.	Width mm	No.	Width mm	
C-shaped travellers	(basic) W	f	hr	hd	hf	rhr	rf	r	1	3.2	2	4.0	
										2	4.0		
deep-bow C-shaped travellers	T	f	hr	hd					1	3.2	2	4.0	
	TM	f	hr	hd					1	3.2	2	4.0	
	TW	f	hr	hd					1	3.2			
	EM	f	hr	hd					1	3.2			
	KM	f	hr	hd					1	3.2			
	EMT	f	hr	hd					1	3.2	2	4.0	
	MT	f	hr	hd					1	3.2			
Elliptical travellers	(basic)	f	hr	hd	hf				1	3.2	2	4.0	
	TW	f	hr	hd					1	3.2	2	4.0	
	W	f	hr	hd					1	3.2			
	EM	f	hr	hd					1	3.2			
	H	f	hr	hd					1	3.2	2	4.0	
	HW	f	hr	hd					1	3.2	2	4.0	
	HWW	f	hr	hd					1	3.2			
Half elliptical travellers	(basic)	f	hr	hd					1	3.2	2	4.0	
	EMT	f	hr	hd					1	3.2			

Wire Profile: r = round; rf = round/flat; rhr = round/half-round; hr = half-round; hd = half-round, wide; hf = half-round, special wide; f = flat

Section on ring travellers by kind permission and with the assistance of Messrs. Reiners + Furst GmbH u. Co.KG, P.O. Box 101340, 41013 Mönchengladbach/Germany









The most usual types of ring travellers for self-lubricating HZ rings

Shape	Ring height	Designation	Types							
			(Basic)	A	B	H	Expr.	Expr. A	Expr. ASK	
			Material							
HZ steel travellers	6.35 mm (1/4")	HZ 6.3	nylon sup.-nyl.	-	-	nylon	-	-	-	-
  	9.5 mm (3/8")	HZ 9.5	steel nylon sup.-nyl.	steel	-	nylon s.nyl.	-	steel	steel	-
 	10.3 mm (13/32")	HZ 10.3	steel nylon sup.-nyl. nyl.-steel	-	-	-	-	steel	steel	-
	11.1 mm (7/16")	HZ 11.1	- nylon sup.-nyl. nyl.-steel	-	-	-	-	-	steel	steel
HZ nylon travellers	16.7 mm (21/32")	HZ 16.7	steel nylon sup.-nyl. nyl.-steel	steel	-	nylon s.nyl.	-	-	steel	-
 	25.4 mm (1")	HZ 25.4	- nylon sup.-nyl. nyl.-steel	-	-	nylon s.nyl.	-	-	-	-
 	38.1 mm (1 1/2")	HZ 38.1	- nylon sup.-nyl. nyl.-steel	-	-	-	-	-	-	-

nylon-steel = nylon travellers with steel insert in the thread passage
super-nylon = glass-fibre reinforced nylon travellers









Examples: HZ 9.5 r type Express steel
HZ 16.7 super-nylon type -B-
HZ 25.4 nylon-steel

The most usual types of ring travellers for self-lubricating J rings

Shape	Ring height	Designation	Types					Expr. A
			(Basic)	A	B	BB		
			Material					
J steel travellers	9.1 mm (23/64")	J 9.1	steel nylon super-nylon	steel	steel	-	-	
  	11.1 mm (7/16")	J 11.1	steel nylon super-nylon nylon-steel	steel	steel	steel	steel	
 								
J nylon travellers	17.4 mm (11/16")	J 17.4	steel nylon super-nylon	steel	-	nylon super-nylon	-	
  								

nylon-steel = nylon travellers with steel insert in the thread passage
super-nylon = glass-fibre reinforced nylon travellers

Examples: J 9.1 r steel
J 11.1 super-nylon

High-Speed Ring Frame			Yarn Count			Standard Ring Frame				
Conventional Spinning		Compact Spinning				Cotton, Rayon Staple, Polyester, Blends		Acrylics	Core Yarns	
Travellers made of			Probable Traveller Number							
flat wire profile	half-round wire profile	half-round wire profile								
 f	 hr	 hr								
 hf	 hf	 hf								
 hd	 hd	 hd								
-	-	-	2.5	250	4	34-38	38-42			
-	-	-	3.5	170	6	26-30	30-34			
-	-	-	5	125	8	20-22	25-28			
-	-	-	6	100	10	16-18	18-20			
-	-	-	7	84	12	14-16	16-18			
-	-	-	8	72	14	12-14	13-15			
6-7	8-10	6-8	10	59	17	9-10	9-11	18-20		
4-5	6-7	5-6	12	50	20	6-7	8-10	13-15		
3-4	4-5	3-4	14	42	24	5-6	6-8	9-11	12-14	
1-2	2-3	2-3	16	37	27	4-5	4-6	8-10	9-10	
1/0-1	1-2	1/0-1	18	33.5	30	3-4	4-5	6-8	8-9	
1/0-2/0	1/0-1	1/0-2/0	20	30	34	2-3	3-4	4-6	7-8	
3/0-4/0	2/0-3/0	3/0-4/0	24	25	40	1/0-1	1-2	3-5	6-7	
3/0-4/0	2/0-3/0	3/0-4/0	26	23	44	1/0-1	1-2	3-4	5-6	
4/0-5/0	3/0-4/0	4/0-5/0	28	21	48	1/0-2/0	1/0-1	2-3	4-5	
4/0-5/0	3/0-4/0	4/0-5/0	30	20	50	1/0-2/0	1/0-1	2-3	3-4	
5/0-6/0	4/0-5/0	5/0-6/0	32	18.5	54	2/0-3/0	1/0-2/0	1-2	2-3	
5/0-6/0	4/0-5/0	5/0-6/0	36	17	60	2/0-3/0	1/0-2/0	1-2	1-2	
6/0-7/0	5/0-6/0	6/0-7/0	38	16	64	3/0-4/0	2/0-3/0	1-1/0	1-1/0	
7/0-8/0	6/0-7/0	8/0-9/0	42	14	70	4/0-5/0	3/0-4/0	1/0-2/0	1/0-2/0	
8/0-9/0	7/0-8/0	9/0-10/0	48	12.5	80	5/0-6/0	4/0-5/0		3/0-4/0	
8/0-9/0	7/0-8/0	9/0-10/0	50	12	85	6/0-7/0	5/0-6/0		4/0-5/0	
9/0-10/0	8/0-9/0	10/0-11/0	54	11	90	7/0-8/0	6/0-7/0		5/0-6/0	
10/0-11/0	9/0-10/0	11/0-12/0	60	10	100	8/0-9/0	7/0-8/0		7/0-8/0	
12/0-14/0	11/0-12/0	13/0-14/0	70	8.3	120	9/0-10/0	8/0-9/0		8/0-9/0	
14/0-16/0	13/0-15/0	15/0-16/0	80	7.6	135	12/0-14/0	10/0-12/0		10/0-12/0	
17/0-19/0	15/0-17/0	17/0-19/0	95	6.4	160	15/0-17/0	13/0-15/0			
18/0-20/0	16/0-18/0	18/0-20/0	100	6	170	16/0-18/0	14/0-16/0			
18/0-20/0	16/0-18/0	18/0-20/0	105	5.6	180	16/0-18/0	15/0-17/0			
20/0-22/0	18/0-20/0	22/0-24/0	120	5	200	18/0-20/0	16/0-18/0			

The correct relative humidity is a decisive factor wherever textile fibres are being processed.

Some important criteria are:

1. **Absolute humidity content**

The absolute air humidity is the momentary amount of water vapour – the water content – in the air. Humidity content is measured in g/kg of dry air.

The higher the temperature, the higher the amount of water vapour – water content – that can be assimilated by the air up to the saturation point.

2. **Relative humidity content**

The relative humidity of the air is the ratio between the absolute air humidity actually present in the air (see 1. above) and the amount of water vapour that would be present in the air if maximum possible saturation of the air were achieved. This ratio is expressed in %. For example: at 7° C (44.6° F) 1 kg (2.2 lb) of dry air at maximum saturation contains 6.29 g (97 grains) of moisture. If the actual air momentarily present at 7° C (44.6° F) contains 4.72 g (73 grains) of water vapour, then:

$$\text{Relative humidity of the air} = \frac{100 \cdot 4.72 \text{ g}}{6.29 \text{ g}} = 75 \% \text{ relative humidity}$$

$$\text{Relative humidity of the air} = \frac{100 \cdot 73 \text{ grains}}{97 \text{ grains}} = 75 \% \text{ relative humidity}$$

Firms processing textile fibres must determine by experiment the ideal air humidity at the various processing stages for each type of fibre material.

The following values have produced good results and may be taken as a guide:

Processing stage	Relative humidity
Separating	45–50 %
Carding and drafting	50–55 %
Combing and slubbing	50–60 %
Spinning	45–60 %
Spooling and doubling	50–55 %
Weaving	75–85 %

The h,x diagram for determining air conditioning factors

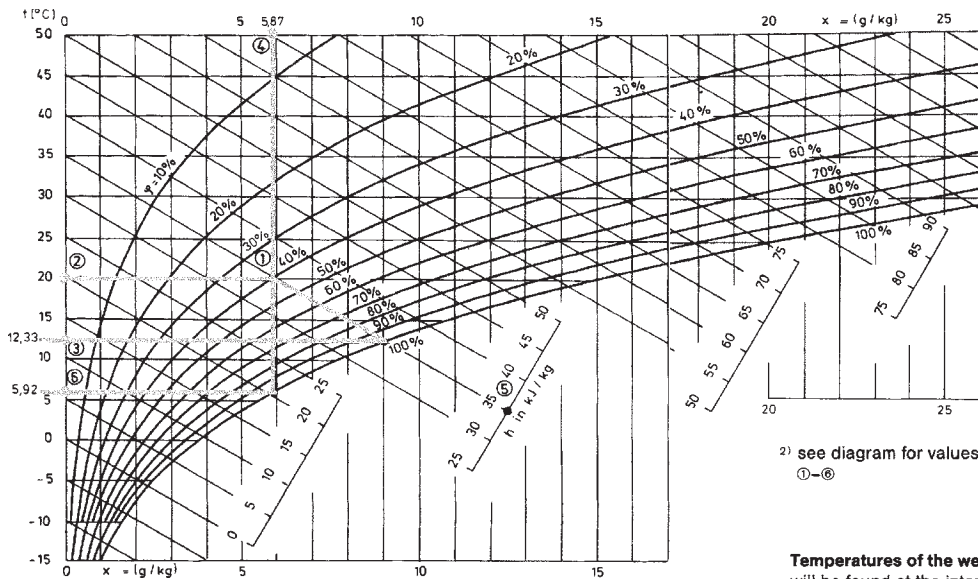

h,x diagram:

- t = air temperature in °C
(dry thermometer)
- φ = relative humidity in %
- i = heat content (enthalpy) in kJ
per kilo of dry air
- x = water content in grams per kilo of dry air

The h,x diagram is based on an air pressure of 1 bar = 10⁵ Pa (Pascal)

Example of a reading²⁾:

- On the diagram 20.0 °C / 40 % rel. hum ①
- Temperature of the dry thermometer: t = 20.0 °C ②
- Temperature of the wet thermometer: t = 12.33 °C ③
- Water content: x = 5.87 g/kg ④
- Heat content: h = 35.1 kJ/kg ⑤
of dry air
- Relative humidity: φ = 40 % ①
- Dew-point temperature: TP = 5.92 °C ③

²⁾ see diagram for values
①-⑥

The h,x diagram for air humidity according to Mollier allows the air conditions and changes in these conditions to be read off and the respective values for temperature, heat content, relative humidity and absolute water content to be determined. It should, as a matter of principle, be remembered that all values given in the h,x diagram are based on 1 kg of dry air.

Explanation of the diagram:

Temperatures of the dry thermometer t °C

The line running from left to right is provided, on the left-hand side, with a temperature scale. Each point on this line corresponds to the temperature value recorded on the left.

Depiction of this h,x diagram by courtesy of Messrs. Wiessner GmbH, Bayreuth.

Temperatures of the wet thermometer t °C

will be found at the intersection of the line h and the saturation line φ = 100 %. Read off against the temperature scale on the left.

Absolute moisture content x (g/kg) water content

designated by the vertical lines. Each point on one of these verticals indicates the identical absolute water content of the air.

Heat content h (kJ/kg)

runs from the saturation line = φ = 100 % upwards to the left.

Relative air humidity in the room in φ %

is represented by the individual lines from φ = 10 % to φ = 100 % (saturation line). At a relative humidity of 100 % the air is fully saturated and can no longer assimilate any more moisture. The advent of additional moisture shows as vapour.

Dew point TP

This is the designation for all air conditions lying on the saturation line φ = 100 %. The dew point temperature is read off on the left-hand temperature scale of the diagram.

British-metric units - conversion table

British-Metric			Metric-British		
Unit	Symbol		Unit	Symbol	
Length					
inch	in	1 in = 25.4 mm	Centimetre	cm	1 cm = 0.394 in
foot	ft	1 ft = 30.5 cm	metre	m	1 m = 3.28 ft
yard	yd	1 yd = 0.914 m	metre	m	1 m = 1.09 yd
furlong	fur	1 fur = 201 m	Kilometre	km	1 km = 4.97 fur
mile	mile	1 mile = 1.61 km	Kilometre	km	1 km = 0.621 mile
mile, naut	n mile	1 n mile = 1.852 km	Kilometre	km	1 km = 0.54 n mile
Weight					
grain	grain	1 grain = 0.0648 g	Gram	g	1 g = 15.432 grain
ounce	oz	1 oz = 28.3 g	Gram	g	1 g = 0.0353 oz
pound	lb	1 lb = 454 g	Kilogram	kg	1 kg = 2.20 lb
stone	stone	1 stone = 6.35 kg	Kilogram	kg	1 kg = 0.157 stone
Area					
square inch	in ²	1 in ² = 6.45 cm ²	square Centimetre	cm ²	1 cm ² = 0.155 in ²
square foot	ft ²	1 ft ² = 929 cm ²	square metre	m ²	1 m ² = 10.8 ft ²
square yard	yd ²	1 yd ² = 0.836 m ²	square metre	m ²	1 m ² = 1.20 yd ²
acre	ac	1 ac = 0.405 ha	Hectare	ha	1 ha = 2.47 ac
square mile	1 sq. mile	= 2.59 km ²	square km	km ²	1 km ² = 0.386 sq. mile
Volume					
cubic inch	in ³	1 in ³ = 16.4 cm ³	Cubic Centimetre	cm ³	1 cm ³ = 0.0610 in ³
cubic foot	ft ³	1 ft ³ = 0.0283 m ³	Cubic metre	m ³	1 m ³ = 35.3 ft ³
cubic yard	yd ³	1 yd ³ = 0.765 m ³	Cubic metre	m ³	1 m ³ = 1.31 yd ³
bus	bus	1 bus = 0.0364 m ³	Cubik metre	m ³	1 m ³ = 27.5 bus
fluid ounce	fl oz	1 fl oz = 28.4 ml	Millilitre	ml	1 ml = 0.0352 fl oz
pint	pt	1 pt = 568 ml UK 1 pt = 473 ml US	Millilitre or Litre	ml	1 Liter = 1.76 pt UK 1 Liter = 2.11 pt US
gallon	gal	1 gal = 4.55 Liter UK 1 gal = 3.79 Liter US	Litre or Cubic metre	l m ³	1 m ³ = 220 gal UK 1 m ³ = 264 gal US
Force					
pound-force	lbf	1 lbf = 4.45 N	Newton	N	1 N = 0.225 lbf
Temperature					
degree Fahrenheit °F	°C = $\frac{5}{9}(\text{°F}-32)$		degree Celsius °C	°C	°F = $\frac{9 \times \text{°C}}{5} + 32$
Power					
horsepower	hp	1 hp = 0.736 kW	Kilowatt	kW	1 kW = 1.36 hp

Millimeter into inches¹⁾ and inches into millimetres Conversion table

mm	0.0 mm	0.1 mm	0.2 mm	0.3 mm	0.4 mm	mm
	inches	inches	inches	inches	inches	
0	–	0.00394	0.00787	0.0118	0.0157	0
1	0.0394	0.0433	0.0472	0.0512	0.0551	1
2	0.0787	0.0827	0.0866	0.0906	0.0945	2
3	0.1181	0.1220	0.1260	0.1299	0.1339	3
4	0.1575	0.1614	0.1654	0.1693	0.1732	4
5	0.1969	0.2008	0.2047	0.2087	0.2126	5
6	0.2362	0.2402	0.2441	0.2480	0.2520	6
7	0.2756	0.2795	0.2835	0.2874	0.2913	7
8	0.3150	0.3189	0.3228	0.3268	0.3307	8
9	0.3543	0.3583	0.3622	0.3661	0.3701	9
10	0.3937	0.3976	0.4016	0.4055	0.4094	10

Example: 3.8 mm = 0.1496"

Inches	Inches	mm	Inches	Inches	mm
–	–	–	1/4	0.25	6.350
1/64	0.015625	0.397	17/64	0.265625	6.747
1/32	0.03125	0.794	9/32	0.28125	7.144
3/64	0.046875	1.191	19/64	0.296875	7.541
1/16	0.0625	1.588	5/16	0.3125	7.938
5/64	0.078125	1.984	21/64	0.328125	8.334
3/32	0.09375	2.381	11/32	0.34375	8.731
7/64	0.109375	2.778	23/64	0.359375	9.128
1/8	0.125	3.175	3/8	0.375	9.525
9/64	0.140625	3.572	25/64	0.390625	9.922
5/32	0.15625	3.969	13/32	0.40625	10.319
11/64	0.171875	4.366	27/64	0.421875	10.716
3/16	0.1875	4.763	7/16	0.4375	11.113
13/64	0.203125	5.159	29/64	0.453125	11.509
7/32	0.21875	5.556	15/32	0.46875	11.906
15/64	0.234375	5.953	31/64	0.484375	12.303

¹⁾ Also previously referred to in German usage as "Zoll"

Millimeter into inches¹⁾ and inches into millimetres Conversion table

mm	0.5 mm	0.6 mm	0.7 mm	0.8 mm	0.9 mm	mm
	inches	inches	inches	inches	inches	
0	0.0197	0.0236	0.0276	0.0315	0.0354	0
1	0.0591	0.0630	0.0669	0.0709	0.0748	1
2	0.0984	0.1024	0.1063	0.1102	0.1142	2
3	0.1378	0.1417	0.1457	0.1496	0.1535	3
4	0.1772	0.1811	0.1850	0.1890	0.1929	4
5	0.2165	0.2205	0.2244	0.2283	0.2323	5
6	0.2559	0.2598	0.2638	0.2677	0.2717	6
7	0.2953	0.2992	0.3031	0.3071	0.3110	7
8	0.3346	0.3386	0.3425	0.3465	0.3504	8
9	0.3740	0.3780	0.3819	0.3858	0.3898	9
10	0.4134	0.4173	0.4213	0.4252	0.4291	10

Inches into millimetres Conversion table

Inches	0.0"	0.1"	0.2"	0.3"	0.4"	Inches
	mm	mm	mm	mm	mm	
0"	0.00	2.540	5.080	7.620	10.16	0"
1"	25.40	27.94	30.48	33.02	35.56	1"
2"	50.80	53.34	55.88	58.42	60.96	2"
3"	76.20	78.74	81.20	83.82	86.36	3"
4"	101.60	104.14	106.68	109.22	111.76	4"
5"	127.00	129.54	132.08	134.62	137.16	5"
6"	152.40	154.94	157.48	160.02	162.56	6"
7"	177.80	180.34	182.88	185.42	187.96	7"
8"	203.20	205.74	208.28	210.82	213.36	8"
9"	228.60	231.14	233.68	236.22	238.76	9"
10"	254.00	256.54	259.09	261.62	264.16	10"

Inches	Inches	mm	Inches	Inches	mm	Inches	0.000"	0.001"	0.002"	0.003"	0.004"	Inches
1/2	0.5	12.700	3/4	0.75	19.050		mm	mm	mm	mm	mm	
	³³ / ₆₄ 0.515625	13.097		⁴⁹ / ₆₄ 0.765625	19.447	0.00"	0.000	0.0254	0.0508	0.0762	0.102	0.00"
	¹⁷ / ₃₂ 0.53125	13.494		²⁵ / ₃₂ 0.78125	19.844	0.01"	0.254	0.279	0.305	0.330	0.356	0.01"
	³⁵ / ₆₄ 0.546875	13.891		⁵¹ / ₆₄ 0.796875	20.241	0.02"	0.508	0.533	0.559	0.584	0.610	0.02"
⁹ / ₁₆	0.5625	14.288	¹³ / ₁₆	0.8125	20.638	0.03"	0.762	0.787	0.813	0.838	0.864	0.03"
	³⁷ / ₆₄ 0.578125	14.684		⁵³ / ₆₄ 0.828125	21.034	0.04"	1.016	1.041	1.067	1.092	1.118	0.04"
	¹⁹ / ₃₂ 0.59375	15.081		²⁷ / ₃₂ 0.84375	21.431	0.05"	1.270	1.295	1.321	1.346	1.372	0.05"
	³⁹ / ₆₄ 0.609375	15.478		⁵⁵ / ₆₄ 0.859375	21.828	0.06"	1.524	1.549	1.575	1.600	1.626	0.06"
⁵ / ₈	0.625	15.875	⁷ / ₈	0.875	22.225	0.07"	1.778	1.803	1.829	1.854	1.880	0.07"
	⁴¹ / ₆₄ 0.640625	16.272		⁵⁷ / ₆₄ 0.890625	22.622	0.08"	2.032	2.057	2.083	2.108	2.134	0.08"
	²¹ / ₃₂ 0.65625	16.669		²⁹ / ₃₂ 0.90625	23.019	0.09"	2.286	2.311	2.337	2.362	2.388	0.09"
	⁴³ / ₆₄ 0.671875	17.066		⁵⁹ / ₆₄ 0.921875	23.416							
¹¹ / ₁₆	0.6875	17.463	¹⁵ / ₁₆	0.9375	23.813							
	⁴⁵ / ₆₄ 0.703125	17.859		⁶¹ / ₆₄ 0.953125	24.209	Example: 7.182 = ? mm						
	²³ / ₃₂ 0.71875	18.256		³¹ / ₃₂ 0.96875	24.606	from upper table	7.1"	= 180.34 mm				
	⁴⁷ / ₆₄ 0.734375	18.653		⁵³ / ₆₄ 0.984375	25.003	from lower table	0.082"	= <u>2.083 mm</u>				
							7.182"	= 182.423 mm				

Example: $3\frac{3}{16}" = 76.20 + 4.763 = 80.963$ mm

¹⁾ Also previously referred to in German usage as "Zoll"

Inches into millimetres Conversion table

Inches	0.5"	0.6"	0.7"	0.8"	0.9"	Inches
	mm	mm	mm	mm	mm	
0"	12.70	15.24	17.78	20.32	22.86	0"
1"	38.10	40.64	43.18	45.72	48.26	1"
2"	63.50	66.04	68.58	71.12	73.66	2"
3"	88.90	91.44	93.98	96.52	99.06	3"
4"	114.30	116.84	119.38	121.92	124.46	4"
5"	139.70	142.24	144.78	147.32	149.86	5"
6"	165.10	167.64	170.18	172.72	175.26	6"
7"	190.50	193.04	195.58	198.12	200.66	7"
8"	215.90	218.44	220.98	223.52	226.06	8"
9"	241.30	243.84	246.38	248.92	251.46	9"
10"	266.70	269.24	271.78	274.32	276.86	10"

Inches	0.005"	0.006"	0.007"	0.008"	0.009"	Inches
	mm	mm	mm	mm	mm	
0.00"	0.127	0.152	0.178	0.203	0.229	0.00"
0.01"	0.381	0.406	0.432	0.457	0.483	0.01"
0.02"	0.635	0.660	0.686	0.711	0.737	0.02"
0.03"	0.889	0.914	0.940	0.965	0.991	0.03"
0.04"	1.143	1.168	1.194	1.219	1.245	0.04"
0.05"	1.397	1.422	1.448	1.473	1.499	0.05"
0.06"	1.651	1.676	1.702	1.727	1.753	0.06"
0.07"	1.905	1.930	1.956	1.981	2.007	0.07"
0.08"	2.159	2.184	2.210	2.235	2.261	0.08"
0.09"	2.413	2.438	2.464	2.489	2.515	0.09"

Introduction of international SI units

The SI system of units (Système internationale d'Unités) was created in order to simplify international co-operation.

The SI units have been adopted by legislation in the EC, the USA, the Soviet Union and the Comecon countries as obligatory units of measurement.

The SI units are frequently-used parameters in science and technology.

Units of pressure

	bar	Pa N/m ²	MPa N/mm ²
1 bar = 1 daN/cm ²	1	10 ⁵	0.1
1 Pa = 1 N/m ²	10 ⁻⁵	1	10 ⁻⁶
1 MPa = 1 N/mm ²	10	10 ⁶	1

Units of energy

	J N m W s	daJ daN m	kW h
1 J = 1 N m = 1 W s	1	0.1	0.278 · 10 ⁻⁶
1 daJ = 1 daN m	10	1	2.78 · 10 ⁻⁶
1 kW h =	3.6 · 10 ⁶	360 000	1

Units of power

	W J/s N m/s	kW
1 W = 1 J/s = 1 N m/s =	1	0.001
1 kW =	1000	1

Units of force

	N	daN
1 N =	1	0.1
1 daN =	10	1

Conversion of units no longer to be used

The names and symbols for the units in the following list are no longer to be used. Their equivalents in the relevant SI units and/or alternative recommended units are given for conversion purposes.

Units no longer to be used		Conversion into relevant SI unit and/or alternative recommended unit	Notes
Name	Symbol		

For units of pressure

Atmosphere, technical	at ata atu atü	1 at = 98.0665 kPa = 0.980 665 bar	The suffixes a, u, ü were used to designate absolute atmosphere, subatmospheric pressure and pressure above atmospheric, see DIN 1314.
Millimetres head of mercury, conventional	mmHg mmQS	1 mmHg = 1.333 22 mbar = 133.322 Pa	
Torr	Torr	1 Torr = 1.333 22 mbar	

For units of energy and power

Horsepower	PS	1 PS = 735.498 75 W	
Kilocalorie	kcal Kal	1 kcal = 1 Kal = 4.1868 kJ	Formerly also referred to as the "large" or "great" calorie and often erroneously referred to in nutritional science simply as a "calorie" (Kal).

For units of pressure, energy and force

Kilopond	kp	1 kp = 9.806 65 N	Formerly used as a unit of force.
----------	----	-------------------	-----------------------------------

General

As multiples or fractions of the units, only integral positive or negative powers of 10 are used. These are designated by symbols as follows:

Multiple of unit	Prefix	Prefix symbol	Fraction of unit	Prefix	Prefix symbol
10 ¹	Deca-	da	10 ⁻¹	Deci-	d
10 ²	Hecto-	h	10 ⁻²	Centi-	c
10 ³	Kilo-	k	10 ⁻³	Milli-	m
10 ⁶	Mega-	M	10 ⁻⁶	Micro-	μ
10 ⁹	Giga-	G	10 ⁻⁹	Nano-	n
10 ¹²	Tera-	T	10 ⁻¹²	Pico-	p
10 ¹⁵	Peta-	P	10 ⁻¹⁵	Femto-	f
10 ¹⁸	Exa-	E	10 ⁻¹⁸	Atto-	a

Sales Companies and Representatives

See Homepage

"About us"

"Worldwide Representatives"

Complete List of Product Reference Numbers

Product Numbers according to ascending Reference Number	2
Products in alphabetic order	16

Complete List of Product Reference Numbers according to ascending Reference Number

Ref. no	Designation	Page
0011 687	Distance gauge	Chapter 5-75
0017 198	Lubricating nozzle	Chapter 4-10
0017 199	Lubricating nozzle	Chapter 4-10
0017 392	Lubricating adapter	Chapter 1-15
0019 956	Oil Isoflex PDP 65	Chapter 8-9
0019 983	Lubricating adapter	Chapter 1-15
0021 818	Lubricating adapter	Chapter 1-15
0026 714	Lubricating nozzle	Chapter 4-10
0026 840	Slide calipers	Chapter 5-75,77
0026 877	TEXParts grease TG2	Chapter 8-3
0026 878	TEXParts grease TG 5	Chapter 8-3
0030 491	Distance clip	Chapter 9-50
0038 425	Isoflex super LDS 18	Chapter 8-8
0968 903	Lubricating nozzle	Chapter 3-10
0993 040	Lubricating nozzle	Chapter 4-10
0993 073	Grease gun size 2	Chapter 3-10
0993 091	Grease gun size 3	Chapter 4-10
0993 551	Screwdriver	Chapter 5-76
0993 570	Hexagon screwdriver	Chapter 5-74,78,79
0993 571	Allen key (key 5)	Chapter 5-78
0993 580	Spanner	Chapter 5-76
0994 122	Height gauge	Chapter 5-75
0994 131	Tool set with bag	Chapter 5-76
0994 231	Pin	Chapter 7-15
0994 252	Lubricating adapter	Chapter 1-15
0994 253	Lubricating adapter	Chapter 1-15
0997 440	Draft field gauge	Chapter 5-75
0997 445	Screwdriver	Chapter 5-77
0997 450	Height gauge	Chapter 5-76
0997 451	Draft field gauge	Chapter 5-76
0997 453	Ratchet	Chapter 5-74,75,76,78,79
0997 454	Screwdriver bit	Chapter 5-75,76
0997 455	Screwdriver bit	Chapter 5-75,77
0997 491	Screwdriver	Chapter 5-75
0998 111	Lubricating adapter	Chapter 1-15
0998 112	Lubricating adapter	Chapter 1-15
0998 222	Setting wrench	Chapter 5-75,76
0998 279	Lubricating adapter	Chapter 1-15
1247 967	Front clearer roller 82,5	Chapter 5-6,10

Ref. no.	Designation	Page
1247 968	Front clearer roller 75	Chapter 5-6,10
1249 383	Allen key (key 4)	Chapter 5-75
1251 491	Lubricating device	Chapter 7-15
1251 683	Tool set with bag	Chapter 5-75
1252 741	Front clearer roller 68,4	Chapter 5-6,10
1253 181	Lubricating adapter	Chapter 1-15
1253 182	Lubricating adapter	Chapter 1-15
1253 413	Lubricating nozzle	Chapter 4-10
1253 433	Front clearer roller 82,5	Chapter 5-3
1253 714	Tool set with bag	Chapter 5-78
1254 106	Spindle lubricating apparatus	Chapter 8-10
1254 214	Draft field gauge	Chapter 1-14
1255 145	Pliers for cover	Chapter 5-78
1255 195	Screwdriver SW 6	Chapter 5-74,78,79
1255 215	Spanner	Chapter 5-78,79
1255 216	Allen key (key 3)	Chapter 5-74,78
1255 219	Tool bag	Chapter 5-74
1256 207	Pliers	Chapter 5-78,79
1256 450	Lubricating adapter	Chapter 1-15
1256 451	Lubricating adapter	Chapter 1-15
1257 477	L-quick-connector	Chapter 5-80,81
1258 491	Connecting piece	Chapter 5-80
1258 593	Front clearer roller holder	Chapter 5-3
1259 479	Tool set with bag	Chapter 5-79
1259 647	T-screwing	Chapter 5-80,81
1259 653	Torque key with insert	Chapter 5-74,79
1259 669	Front clearer roller 68.4	Chapter 5-3
1259 669	Front clearer roller 75	Chapter 5-3
1259 713	Ball screwdriver	Chapter 5-74
1260 156	Height setting gauge	Chapter 5-74
1260 216	Height setting gauge	Chapter 5-79
1260 233	Lubricating adapter	Chapter 1-15
1261 442	Pneumatic unit	Chapter 5-80,81
1261 445	Pneumatic unit	Chapter 5-80,81
6000 639	Draft field gauge	Chapter 5-79
6001 019	Lubrication adapter	Chapter 1-15
6001 102	Draft field gauge	Chapter 5-74
6001 490	Tube cutter	Chapter 5-74,79
A		
ADZ-0013 365	Distance piece	Chapter 2-3
AR 3528-1254 633	Contact roll assembly 82,5	Chapter 2-4
AR 3528-1254 645	Contact roll assembly 70	Chapter 2-4

Ref. no.	Designation	Page
AR 3528-1254 646	Contact roll assembly 75	Chapter 2-4
AR 3528-1254 647	Contact roll assembly 82,5	Chapter 2-4
AR 3528-1256 546	Contact roll assembly 75	Chapter 2-4
AR 3528-1256 547	Contact roll assembly 82,5	Chapter 2-4
AR 50-0027 195	Contact roll assemblies	Chapter 8-2
AR 50-0027 196	Contact roll assemblies	Chapter 8-2
AR 50-0028 249	Contact roll assembly 75	Chapter 2-7
AR 50-0030 023	Contact roll assembly 75 left	Chapter 2-7
AR 50-0030 027	Contact roll assembly 75 right	Chapter 2-7
AR 50-1246 555	Contact roll assembly 75	Chapter 8-2
AR 50-1246 645	Contact roll assembly 75 right	Chapter 2-7
AR 50-1246 647	Contact roll assembly 75 left	Chapter 2-7
AR 5024-1253 936	Contact roll assembly 75	Chapter 2-6
AR 5024-1253 978	Contact roll assembly 70	Chapter 2-6
AR 5024-1253 987	Contact roll assembly 75 left	Chapter 2-6
AR 5024-1253 990	Contact roll assembly 70 right	Chapter 2-6
AR 5024-1253 986	Contact roll assembly 70 left	Chapter 2-6
AR 5024-1253 991	Contact roll assembly 75 right	Chapter 2-6
AR 5047-1253 935	Contact roll assembly 75	Chapter 2-2
AR 5047-1253 979	Contact roll assembly 70	Chapter 2-2
AR 5047-1253 980	Contact roll assembly 82,5	Chapter 2-2
C		
CHT-1251 471	Bracket for counter roll	Chapter 7-4
CK 11-0007 749	Bearing unit	Chapter 2-12
CK 12-0000 319	Bearing unit	Chapter 7-12
CK 12-0030 848	Draw-off roller	Chapter 2-22
CK 13-0010 092	Bearing unit	Chapter 6-10
CK 13-0013 744	Bearing unit	Chapter 6-10
CK 13-0020 824	Bearing unit	Chapter 6-10
CK 13-0029 170	Bearing unit	Chapter 6-10
CK 14-0028 695	Bearing unit	Chapter 6-10
CK 15-1252 746	Bearing unit	Chapter 7-14
CK 668- 0018 773	Counter roll	Chapter 7-6
CK 668-0012 083	Counter roll	Chapter 7-4,5
CK 668-0017 992	Counter roll	Chapter 7-4
CK12-0000 319	Bearing unit	Chapter 8-8
CK12-1248 719	Draw off roller with cot	Chapter 2-22

Ref. no.	Designation	Page
CK12-1250611	Draw off roller	Chapter 2-22
CR 2-0035 905	Bearing unit	Chapter 2-18
CS	Spindle bearing unit	Chapter 8-5
CS1- CWL-0012 117	Spindle units CS1 Wharve	Chapter 1-6 Chapter 7-5
D		
DR 1620-0958 201	Bearing unit	Chapter 2-20
DR 1620-0958 251	Bearing unit	Chapter 2-20
DR 1625-0958 351	Bearing unit	Chapter 2-20
DR 1922-0958 601	Bearing unit	Chapter 2-20
DR 1922-0958 651	Bearing unit	Chapter 2-20
DR 1922-0958 551	Bearing unit	Chapter 8-3
E		
EB 226-0030 746	Elastic bush	Chapter 6-2
F		
FKA-0019 933	Protecting cap	Chapter 7-4
FL 15-0029 812	False twist bearing unit	Chapter 7-8,9
FL 15-0033 442	False twist bearing unit	Chapter 7-8,9
FL 15-1252 742	False twist bearing unit	Chapter 7-7
FL 15-1252 743	False twist bearing unit	Chapter 7-7
FL 15-1254 440	False twist bearing unit	Chapter 7-7
FL 15-1254 441	False twist bearing unit	Chapter 7-7
FL 66-0013 055	False twist bearing unit	Chapter 7-2
FMT-0010 953	Nut	Chapter 7-4
FR 232-0964 351	Bearing unit	Chapter 2-14
H		
HF	Spindle bearing unit	Chapter 8-5
HF 3-0952 502	Spindle bearing unit	Chapter 1-2
HF 3-0952 503	Spindle bearing unit	Chapter 1-2
HF 35-1254 243	Spindle bearing unit	Chapter 1-2
HF 44-0952 757	Spindle bearing unit	Chapter 1-2

Ref. no.	Designation	Page
HF 44-0952 760	Spindle bearing unit	Chapter 1-2
HF 45-1258 940	Spindle bearing unit	Chapter 1-2
HZ	Spindle bearing unit	Chapter 8-6
HZ 35-0018 299	Spindle bearing unit	Chapter 1-4
HZ 66-0014 227	Spindle bearing unit	Chapter 1-4
HZ 68-0017 830	Spindle bearing unit	Chapter 1-4
HZ 77-0952 381	Spindle bearing unit	Chapter 1-4
I		
IL 13-1249 087	Bearing unit	Chapter 6-10
IL 13-1257 771	Bearing unit	Chapter 6-10
K		
KL-0011 034	Rear roving guide	Chapter 5-66
KL-0997 469	Rear zone condenser	Chapter 5-70 Chapter 9-76,86
KL-0998 282	Front zone condenser	Chapter 5-66 Chapter 9-65
KL-0998 283	Front zone condenser	Chapter 5-66 Chapter 9-65
KL-0998 284	Front zone condenser	Chapter 5-66 Chapter 9-65
KL-0998 285	Front zone condenser	Chapter 5-66 Chapter 9-65
KL-1246 070	Front zone condenser 82.5	Chapter 5-68 Chapter 9-76,86
KL-1246 243	Front zone condenser 75	Chapter 5-68 Chapter 9-76,86
KL-1246 244	Front zone condenser	Chapter 5-68 Chapter 9-86
KL-1248 233	Front zone condenser 75	Chapter 5-68 Chapter 9-76,86
KL-1248 234	Front zone condenser 82.5	Chapter 5-68 Chapter 9-76,86
KL-1248 235	Front zone condenser	Chapter 5-68 Chapter 9-86
L		
LE 222-1257 825	Beater spindle	Chapter 6-8
LE 222-0016 427	Beater spindle	Chapter 6-6
LE 222-0022 647	Beater spindle with wharve	Chapter 6-6
LE 222-0027 128	Beater spindle with wharve	Chapter 6-8
LE 222-0035 965	Beater spindle with wharve	Chapter 6-8

Ref. no.	Designation	Page
LE 222-1252 507	Beater spindle with wharve	Chapter 6-8
LP	Top rollers	Chapter 8-4
LP 1002-0956 274	Top roller 100	Chapter 3-2
LP 1002-1248 379	Top roller 75	Chapter 3-2
LP 1002-1248 382	Top roller 82.5	Chapter 5- 4, 8, 12 Chapter 3-2
LP 1002-1248 601	Top roller 75	Chapter 5-4, 8, 12 Chapter 3-3
LP 1002-1249 324	Top roller 68.4	Chapter 5-4, 8, 12 Chapter 3- 2
LP 1002-1256 896	Top roller 82.5	Chapter 5-4, 8, 12 Chapter 3-3
LP 1002-1256 897	Top roller	Chapter 5-4, 8, 12
LP 1002-1256 898	Top roller 90	Chapter 3- 2 Chapter 5-4, 8, 12
LP 1003-1256 596	Top roller 68.4	Chapter 3-4 Chapter 5-4, 8, 12
LP 1003-1256 597	Top roller 75	Chapter 3-4 Chapter 5-4, 8, 12
LP 1003-1256 598	Top roller 82.5	Chapter 3-4 Chapter 5-4, 8, 12
LP 1003-1256 599	Top roller 90	Chapter 3-4
LP 1014-0025 222	Top roller 100	Chapter 3-5
LP 1014-1253 740	Top roller 75	Chapter 3- 5 Chapter 5-28,32
LP 1014-1253 741	Top roller 82.5	Chapter 9-71 Chapter 3-5
LP 1014-1253 742	Top roller 90	Chapter 5-28,32 Chapter 3-5 Chapter 5-32
LP 1015-0025 227	Top roller 100	Chapter 3-6 Chapter 5-22,24
LP 1015-0025 228	Top roller 110	Chapter 5-16, 18, 22, 24 Chapter 3-6 Chapter 9-51
LP 1015-0025 229	Top roller 130	Chapter 3-6 Chapter 5-22, 24
LP 1015-1253 744	Top roller 82.5	Chapter 3-6 Chapter 5-28 Chapter 9-71

Ref. no.	Designation	Page
LP 1015-1253 745	Top roller 90	Chapter 3-6
LP 1016-1256 711	Top roller 75	Chapter 3-7 Chapter 5-32 Chapter 9-82
LP 1017-0013 010	Top roller 100	Chapter 3-7 Chapter 5-22,24 Chapter 9-62,82
LP 1017-0013 011	Top roller 110	Chapter 3-7 Chapter 5-22,24 Chapter 9-62
LP 1017-0013 012	Top roller 130	Chapter 3-7 Chapter 5-22,24 Chapter 9-62
LP 1017-1256 712	Top roller 82.5	Chapter 5-32 Chapter 3-7 Chapter 9-82
LP 1017-1256 713	Top roller 90	Chapter 5-32 Chapter 3-7 Chapter 9-82
LP 302-0010 011	Top roller 80	Chapter 3-9
LP 302-0010 014	Top roller 70	Chapter 3-9
LP 302-0010 015	Top roller 75	Chapter 3-9
LP 302-0010 016	Top roller 90	Chapter 3-9
LP 302-0015 895	Top roller 75	Chapter 3-8
LP 302-0019 135	Top roller 70	Chapter 3-8
LP 302-0019 136	Top roller 80	Chapter 3-8
LP 302-0019 137	Top roller 90	Chapter 3-8
LPDE -1260 210	End cover	Chapter 3-2,3,4,5,6,7,8,9
O		
OH 122-0963 495	Top apron cradle 68.4	Chapter 5-8,12,42,44 Chapter 9-36
OH 122-0963 500	Top apron cradle 75	Chapter 5-8,12,42,44 Chapter 9-36
OH 122-0963 511	Top apron cradle 82.5	Chapter 5-4,8,12,42,44 Chapter 9-36
OH 1225-6001 257	Top apron cradle 75	Chapter 5-4,42 Chapter 9-24

Ref. no.	Designation	Page
OH 1225-6001 674	Top apron cradle 68.4	Chapter 5-4,42 Chapter 9-24
OH 1225-6001 675	Top apron cradle 82.5	Chapter 5-4,42 Chapter 9-24
OH 132-0963 660	Top apron cradle 75	Chapter 5-8,12,40
OH 132-0963 671	Top apron cradle 82.5	Chapter 5-8,12,40 Chapter 9-36
OH 132-0963 700	Top apron cradle 68.4	Chapter 5-8,12,40
OH 2022-1247 887	Top apron cradle 75	Chapter 5-4,8,12,34 Chapter 9-24,36
OH 2022-1247 888	Top apron cradle 68.4	Chapter 5-4,8,12,34 Chapter 9-24,36
OH 2022-1247 889	Top apron cradle 82.5	Chapter 5-4,8,12,34 Chapter 9-24,36
OH 2042-1250 133	Top apron cradle 68.4	Chapter 5-4,8,12,38 Chapter 9-24,36
OH 2042-1250 134	Top apron cradle 75	Chapter 5-4,8,12,38 Chapter 9-24,36
OH 2402-1253 436	Top apron cradle 75	Chapter 5-32,58
OH 2402-1253 437	Top apron cradle 82.5	Chapter 5-32,58
OH 5022-1259 297	Top apron cradle 110	Chapter 5-16,18,46 Chapter 9-51
OH 5042-1259 506	Top apron cradle 110	Chapter 5-16,18,50 Chapter 9-51
OH 514-0962 744	Top apron cradle 82.5	Chapter 5-48
OH 514-0962 745	Top apron cradle 100	Chapter 5-22,24,48 Chapter 9-62
OH 514-0962 746	Top apron cradle 110	Chapter 5-48 Chapter 9-62
OH 514-0962 747	Top apron cradle 130	Chapter 5-22,24,48 Chapter 9-62
OH 524-0962 753	Top apron cradle 82.5	Chapter 5-56
OH 524-0962 755	Top apron cradle 110	Chapter 5-22,56 Chapter 9-62
OH 5245-1260 370	Top apron cradle 110	Chapter 5-16,54 Chapter 9-51

Ref. no.	Designation	Page
OH 534-0962 764	Top apron cradle 100	Chapter 5-22,52 Chapter 9-62
OH 534-0962 765	Top apron cradle 110	Chapter 5-22,52 Chapter 9-62
OH 534-0962 766	Top apron cradle 130	Chapter 5-22,52 Chapter 9-62
OH 554-0962 767	Top apron cradle 75	Chapter 5-32,60
OH 554-0962 768	Top apron cradle 82.5	Chapter 5-32,60
OH 554-0962 769	Top apron cradle 90	Chapter 5-32,60
OH 6022-1254 311	Top apron cradle 75	Chapter 5-28,62
OH 6022-1254 312	Top apron cradle 82.5	Chapter 5-28,62
OH 62-0962 841	Top apron cradle 90	Chapter 5-4,8,12,36 Chapter 9-36
OLC-0004 587	Distance clip	Chapter 5-72
OLC-0004 588	Distance clip	Chapter 9-25,37,71,72,82
OLC-0004 589	Distance clip	Chapter 9-25,37,71,72,82 Chapter 5-72
OLC-0007 685	Distance clip	Chapter 9-72,82
OLC-0007 686	Distance clip	Chapter 5-73
OLC-0007 687	Distance clip	Chapter 5-73
OLC-0007 688	Distance clip	Chapter 5-73
OLC-0017 627	Distance clip	Chapter 5-72
OLC-0017 705	Distance clip	Chapter 9-24,25,36,37 Chapter 5-72
OLC-0030 491	Distance clip	Chapter 9-24,25,36,37 Chapter 5-73
OLC-0964 102	Distance clip	Chapter 9-50
OLC-0964 103	Distance clip	Chapter 5-73
OLC-0964 104	Distance clip	Chapter 5-73
OLC-0964 105	Distance clip	Chapter 9-50,51,62 Chapter 5-73
OLC-0964 106	Distance clip	Chapter 5-73 Chapter 9-50
OLC-0964 107	Distance clip	Chapter 9-50,51,62 Chapter 5-73
OLC-0964 108	Distance clip	Chapter 5-73 Chapter 9-50
OLC-0964 109	Distance clip	Chapter 9-50,51,62 Chapter 5-73

Ref. no.	Designation	Page
OLC-0964 110	Distance clip	Chapter 9-50
	Distance clip	Chapter 5-73
		Chapter 9-50
OLC-0964 117	Distance clip	Chapter 5-72
		Chapter 9-24,25,36,37
OLC-0964 118	Distance clip	Chapter 5-72
		Chapter 9-24,25,36,37
OLC-0964 119	Distance clip	Chapter 5-72
		Chapter 9-24,25,36,37
OLC-0964 120	Distance clip	Chapter 5-72
		Chapter 9-25,37,71,72,82
OLC-0964 123	Distance clip	Chapter 5-72
		Chapter 9-72,82
OLC-0964 124	Distance clip	Chapter 5-72
		Chapter 5-72
P		
PEL-0735 302	Front guide element	Chapter 9-80
PEL-0735 303	Middle guide element	Chapter 9-80
PEL-0735 305	Rear guide element	Chapter 9-80
PFE-0908 212	Clearer roller holder	Chapter 5-7,11
PFE-0996 685	Clearer roller holder	Chapter 5-21,31
PFE-0997 405	Spring	Chapter 5-68
PK 1500-0001 938	Weighting arm	Chapter 5-20,24
		Chapter 9-56,57,58,59,60
PK 1500-0962 602	Weighting arm	Chapter 5-20,22
		Chapter 9-55,57,58,59,60
PK 1500-0962 604	Weighting arm	Chapter 5-20,22
		Chapter 9-55,57,58,59,60
PK 1601-0962 670	Weighting arm	Chapter 5-30,32
		Chapter 9-77,79
PK 2025-1251 331	Weighting arm	Chapter 5-6,8
		Chapter 9-28,31,33
PK 2035-1251 784	Weighting arm	Chapter 5-6,8
		Chapter 9-28,31,33
PK 2055-1251 785	Weighting arm	Chapter 5-10,12
		Chapter 9-28,31,33
PK 2065-1251 786	Weighting arm	Chapter 5-10,12
		Chapter 9-28,31,33

Ref. no.	Designation	Page
PK 3025-1257 300	Weighting arm	Chapter 5-2,4
PK 3035-1259 710	Weighting arm	Chapter 9-18,20,21 Chapter 5-2,4 Chapter 9-18,20,21
PK 5025-1259 471	Weighting arm	Chapter 5-14,16 Chapter 9-42,45,46,49
PK 5025-1259 472	Weighting arm	Chapter 5-15,18 Chapter 9-42,45,46,49
PK 5035-1259 473	Weighting arm	Chapter 5-14,16 Chapter 9-42,45,46,49
PK 5035-1259 474	Weighting arm	Chapter 5-15,18 Chapter 9-42,45,46,49
PK 6000-1252 924	Weighting arm	Chapter 5-26,28 Chapter 9-66,68
PKHA-1252 848	Mono clearer roller holder	Chapter 5-27
PKPW-1253 433	Mono clearer roller	Chapter 5-27
PPH-0727 593	Lateral clearer roller holder	Chapter 5-21
PR-0022 858	Top apron	Chapter 9-71
PR-1253 678	Top apron	Chapter 9-71
Profile P1	Bottom apron nose bar P1	Chapter 5-64
Profile P2	Bottom apron nose bar P2	Chapter 5-64
Profile P3	Bottom apron nose bar P3	Chapter 5-65
S		
SMM 32-1280 013	Spindle bearing unit	Chapter 1-10
SMM 42-1280 014	Spindle bearing unit	Chapter 1-10
SMM-32	Spindle bearing unit	Chapter 8-12
SMM-42	Spindle bearing unit	Chapter 8-12
SMT-0012 478	Nut	Chapter 2-13
SR 23-0028 528	Bearing unit	Chapter 2-16
SR 23-0953 801	Bearing unit	Chapter 2-16 Chapter 6-12
SR 23-0953 901	Bearing unit	Chapter 2-16 Chapter 6-12
SR 23-0008 620	Bearing unit	Chapter 8-3
SR 23-0020 650	Bearing unit	Chapter 8-3

Ref. no.	Designation	Page
SR 23-0954 030	Bearing unit	Chapter 8-3
SR 23-0954 031	Tape tension pulley	Chapter 8-2
SR 23-0954 032	Tape tension pulley	Chapter 8-2
SR 23-0954 034	Tape tension pulley	Chapter 8-2
SR 23-0954 035	Tape tension pulley	Chapter 8-2
SR 24-0027 755	Bearing unit	Chapter 2-16
SR 24-0954 051	Bearing unit	Chapter 2-16
SR 28-0012 473	Tension pulley	Chapter 2-12 Chapter 8-2
SR 28-0012 474	Tension pulley	Chapter 2-12 Chapter 8-2
SR 28-0015 799	Tape tension pulley	Chapter 8-2
SR 35-0027 671	Bearing unit	Chapter 2-16
SR 35-0954 151	Bearing unit	Chapter 2-16
SR 45-0028 044	Tension pulley	Chapter 2-12
SR 45-0008 937	Tape tension pulley	Chapter 8-2
SR 45-0028 044	Tape tension pulley	Chapter 8-2
SR 5047-1255 461	Tape tension pulley	Chapter 8-2
SR 5047-1255 698	Tension pulley	Chapter 2-10
SR 5047-1255 699	Tape tension pulley	Chapter 8-2
SR 7-0030 782	Tape tension pulley	Chapter 2-10
SR 9-0953 201	Tape tension pulley	Chapter 8-2
T		
TL 226-1245 856	Rotor spindle	Chapter 6-2 Chapter 8-9
TL 240-0018 814	Rotor spindle	Chapter 6-4
U		
UCL-0964 125	Locating clip	Chapter 4-6
UCL-0964 126	Locating clip	Chapter 4-6
UCL-0964 127	Locating clip	Chapter 4-6
UCL-0964 128	Locating clip	Chapter 4-6
UCL-0964 129	Locating clip	Chapter 4-6
UCL-0964 136	Locating clip	Chapter 4-6

Ref. no.	Designation	Page
UL	Bottom roller bearings	Chapter 8-4
UL 28-0000 416	Bottom roller bearing	Chapter 4-2
UL 28-0000 417	Bottom roller bearing	Chapter 4-2
UL 28-0000 418	Bottom roller bearing	Chapter 4-2
UL 28-0010 047	Bottom roller bearing	Chapter 4-2
UL 28-0010 080	Bottom roller bearing	Chapter 4-2
UL 28-0010 083	Bottom roller bearing	Chapter 4-2
UL 28-0021 164	Bottom roller bearing	Chapter 4-2
UL 28-0959 263	Bottom roller bearing	Chapter 4-6
UL 28-0959 273	Bottom roller bearing	Chapter 4-6
UL 28-0959 274	Bottom roller bearing	Chapter 4-6
UL 28-1259 366	Bottom roller bearing	Chapter 4-8
UL 30-0002 610	Bottom roller bearing	Chapter 4-2
UL 30-0003 665	Bottom roller bearing	Chapter 4-4
UL 30-0007 871	Bottom roller bearing	Chapter 4-4
UL 30-0018 195	Bottom roller bearing	Chapter 4-2
UL 30-0021 106	Bottom roller bearing	Chapter 4-2
UL 30-0026 220	Bottom roller bearing	Chapter 4-2
UL 30-0028 276	Bottom roller bearing	Chapter 4-4
UL 32-0000 421	Bottom roller bearing	Chapter 4-2
UL 32-0000 422	Bottom roller bearing	Chapter 4-2
UL 32-0000 423	Bottom roller bearing	Chapter 4-2
UL 32-0012 499	Bottom roller bearing	Chapter 4-2
UL 32-0013 400	Bottom roller bearing	Chapter 4-4
UL 32-0015 143	Bottom roller bearing	Chapter 4-4
UL 32-0016 548	Bottom roller bearing	Chapter 4-4
UL 32-0017 390	Bottom roller bearing	Chapter 4-8
UL 32-0019 169	Bottom roller bearing	Chapter 4-4
UL 32-0023 114	Bottom roller bearing	Chapter 4-4
UL 32-0036 128	Bottom roller bearing	Chapter 4-8
UL 32-0959 261	Bottom roller bearing	Chapter 4-6
UL 32-0959 262	Bottom roller bearing	Chapter 4-6
UL 36-0000 424	Bottom roller bearing	Chapter 4-2
UL 36-0000 425	Bottom roller bearing	Chapter 4-2
UL 36-0000 426	Bottom roller bearing	Chapter 4-2
UL 36-0014 782	Bottom roller bearing	Chapter 4-4
UL 36-0016 442	Bottom roller bearing	Chapter 4-4
UL 36-0028 421	Bottom roller bearing	Chapter 4-2
UL 36-0959 265	Bottom roller bearing	Chapter 4-6
UL 36-1248 201	Bottom roller bearing	Chapter 4-2
UL 40-0021 786	Bottom roller bearing	Chapter 4-2
UL 40-0025 408	Bottom roller bearing	Chapter 4-4

Ref. no.	Designation	Page
UL 45-0959 268	Bottom roller bearing	Chapter 4-6
UL 28-0003 590	Bottom roller bearing	Chapter 4-4
V		
VDE-0002 607	Plastic cover	Chapter 7-15
VDE-0911 030	Plastic cover	Chapter 7-15
VR 1-0964 428	Separator roll	Chapter 7-10
		Chapter 8-8
VR 11-0964 434	Separator roll	Chapter 7-10
VR 2-0964 430	Separator roll	Chapter 8-8
VR 2-0964 430	Separator roll	Chapter 7-10
VR 3-0025 015	Separator roll	Chapter 7-10
VR 3-0964 429	Separator roll	Chapter 7-10
		Chapter 8-8
VR 3-0964 435	Separator roll	Chapter 7-10
		Chapter 8-8
VR 4-0964 445	Separator roll	Chapter 8-8
VR 4-0964 438	Separator roll	Chapter 7-10
		Chapter 8-8
VR 4-0964 445	Separator roll	Chapter 7-10
VR 50-0964 450	Separator roll	Chapter 8-8
VR 6-0964 442	Separator roll	Chapter 7-10
		Chapter 8-8
VR 7-0000 320	Separator roll	Chapter 7-12
		Chapter 8-8
VR 7-0964 441	Separator roll	Chapter 7-10
		Chapter 8-8
VR 7-0964 447	Separator roll	Chapter 7-10
		Chapter 8-8
VR 8-0964 426	Separator roll	Chapter 7-10
		Chapter 8-8
VR11-0964 434	Separator roll	Chapter 8-8
Z		
ZB 7-0009 023	Bearing unit	Chapter 2-8
		Chapter 6-12
ZL 7-0009 941	Bearing unit	Chapter 2-8
ZL -0028 553	Bearing unit	Chapter 2-18
ZL 17-0016 949	Bearing unit	Chapter 2-18
ZL 1828-1258 200	Bearing unit	Chapter 6-13
ZL 20-1250 392	Draw off roller with cot	Chapter 2-22
ZL 20-1252 714	Draw off roller with cot	Chapter 2-22
ZL 20-1256 486	Draw-off roller	Chapter 2-22

Complete List of Product Reference Numbers Products in alphabetic order

Designation	Ref. no.	Page
Allen key (key 3)	1255 216	Chapter 5-74, 78
Allen key (key 4)	1249 383	Chapter 5-75
Allen key (key 5)	0993 571	Chapter 5-78
Ball screwdriver	1259 713	Chapter 5-74
Bearing unit	CK 11-0007 749	Chapter 2-12
Bearing unit	CK 12-0000 319	Chapter 7-12 Chapter 8-8
Bearing unit	CK 13-0010 092	Chapter 6-10
Bearing unit	CK 13-0013 744	Chapter 6-10
Bearing unit	CK 13-0020 824	Chapter 6-10
Bearing unit	CK 13-0029 170	Chapter 6-10
Bearing unit	CK 14-0028 695	Chapter 6-10
Bearing unit	CK 15-1252 746	Chapter 7-14
Bearing unit	CR 2-0035 905	Chapter 2-18
Bearing unit	DR 1620-0958 201	Chapter 2-20
Bearing unit	DR 1620-0958 251	Chapter 2-20
Bearing unit	DR 1625-0958 351	Chapter 2-20
Bearing unit	DR 1922-0958 551	Chapter 8-3
Bearing unit	DR 1922-0958 601	Chapter 2-20
Bearing unit	DR 1922-0958 651	Chapter 2-20
Bearing unit	FR 232-0964 351	Chapter 2-14
Bearing unit	IL 13-1249 087	Chapter 6-10
Bearing unit	IL 13-1257 771	Chapter 6-10
Bearing unit	SR 23-0008 620	Chapter 8-3
Bearing unit	SR 23-0028 528	Chapter 2-16
Bearing unit	SR 23-0953 801	Chapter 6-12
Bearing unit	SR 23-0953 901	Chapter 2-16
Bearing unit	SR 23-0954 030	Chapter 6-12
Bearing unit	SR 24-0027 755	Chapter 8-3
Bearing unit	SR 24-0954 051	Chapter 2-16
Bearing unit	SR 35-0027 671	Chapter 2-16
Bearing unit	SR 35-0954 151	Chapter 2-16
Bearing unit	ZB 7-0009 023	Chapter 2-8 Chapter 6-12
Bearing unit	ZL -0028 553	Chapter 2-18
Bearing unit	ZL 17-0016 949	Chapter 2-18
Bearing unit	ZL 1828-1258 200	Chapter 6-13
Bearing unit	ZL 7-0009 941	Chapter 2-8
Beater spindle	LE 222-1257 825	Chapter 6-8
Beater spindle	LE 222-0016 427	Chapter 6-6

Designation	Ref. no.	Page
Beater spindle with wharve	LE 222-0022 647	Chapter 6-6
Beater spindle with wharve	LE 222-0027 128	Chapter 6-8
Beater spindle with wharve	LE 222-0035 965	Chapter 6-8
Beater spindle with wharve	LE 222-1252 507	Chapter 6-8
Bottom apron nose bar P1	Profile P1	Chapter 5-64
Bottom apron nose bar P2	Profile P2	Chapter 5-64
Bottom apron nose bar P3	Profile P3	Chapter 5-65
Bottom roller bearings	UL	Chapter 8-4
Bottom roller bearing	UL 28-0000 416	Chapter 4-2
Bottom roller bearing	UL 28-0000 417	Chapter 4-2
Bottom roller bearing	UL 28-0000 418	Chapter 4-2
Bottom roller bearing	UL 28-0003 590	Chapter 4-4
Bottom roller bearing	UL 28-0010 047	Chapter 4-2
Bottom roller bearing	UL 28-0010 080	Chapter 4-2
Bottom roller bearing	UL 28-0010 083	Chapter 4-2
Bottom roller bearing	UL 28-0021 164	Chapter 4-2
Bottom roller bearing	UL 28-0959 263	Chapter 4-6
Bottom roller bearing	UL 28-0959 273	Chapter 4-6
Bottom roller bearing	UL 28-0959 274	Chapter 4-6
Bottom roller bearing	UL 28-1259 366	Chapter 4-8
Bottom roller bearing	UL 30-0002 610	Chapter 4-2
Bottom roller bearing	UL 30-0003 665	Chapter 4-4
Bottom roller bearing	UL 30-0007 871	Chapter 4-4
Bottom roller bearing	UL 30-0018 195	Chapter 4-2
Bottom roller bearing	UL 30-0021 106	Chapter 4-2
Bottom roller bearing	UL 30-0026 220	Chapter 4-2
Bottom roller bearing	UL 30-0028 276	Chapter 4-4
Bottom roller bearing	UL 32-0000 421	Chapter 4-2
Bottom roller bearing	UL 32-0000 422	Chapter 4-2
Bottom roller bearing	UL 32-0000 423	Chapter 4-2
Bottom roller bearing	UL 32-0012 499	Chapter 4-2
Bottom roller bearing	UL 32-0013 400	Chapter 4-4
Bottom roller bearing	UL 32-0015 143	Chapter 4-4
Bottom roller bearing	UL 32-0016 548	Chapter 4-4
Bottom roller bearing	UL 32-0017 390	Chapter 4-8
Bottom roller bearing	UL 32-0019 169	Chapter 4-4
Bottom roller bearing	UL 32-0023 114	Chapter 4-4
Bottom roller bearing	UL 32-0036 128	Chapter 4-8
Bottom roller bearing	UL 32-0959 261	Chapter 4-6
Bottom roller bearing	UL 32-0959 262	Chapter 4-6
Bottom roller bearing	UL 36-0000 424	Chapter 4-2
Bottom roller bearing	UL 36-0000 425	Chapter 4-2
Bottom roller bearing	UL 36-0000 426	Chapter 4-2
Bottom roller bearing	UL 36-0014 782	Chapter 4-4

Designation	Ref. no.	Page
Bottom roller bearing	UL 36-0016 442	Chapter 4-4
Bottom roller bearing	UL 36-0028 421	Chapter 4-2
Bottom roller bearing	UL 36-0959 265	Chapter 4-6
Bottom roller bearing	UL 36-1248 201	Chapter 4-2
Bottom roller bearing	UL 40-0021 786	Chapter 4-2
Bottom roller bearing	UL 40-0025 408	Chapter 4-4
Bottom roller bearing	UL 45-0959 268	Chapter 4-6
Bracket for counter roll	CHT-1251 471	Chapter 7-4
Clearer roller holder	PFE-0908 212	Chapter 5-7,11
Clearer roller holder	PFE-0996 685	Chapter 5-21,31
Connecting piece	1258 491	Chapter 5-80
Contact roll assembly 82,5	AR 3528-1254 633	Chapter 2-4
Contact roll assembly 70	AR 3528-1254 645	Chapter 2-4
Contact roll assembly 75	AR 3528-1254 646	Chapter 2-4
Contact roll assembly 82,5	AR 3528-1254 647	Chapter 2-4
Contact roll assembly 75	AR 3528-1256 546	Chapter 2-4
Contact roll assembly 82,5	AR 3528-1256 547	Chapter 2-4
Contact roll assemblies	AR 50-0027 195	Chapter 8-2
Contact roll assemblies	AR 50-0027 196	Chapter 8-2
Contact roll assembly 75	AR 50-0028 249	Chapter 2-7
Contact roll assembly 75 left	AR 50-0030 023	Chapter 2-7
Contact roll assembly 75 right	AR 50-0030 027	Chapter 2-7
Contact roll assembly 75	AR 50-1246 555	Chapter 2-7
Contact roll assembly 75 right	AR 50-1246 645	Chapter 2-7
Contact roll assembly 75 left	AR 50-1246 647	Chapter 2-7
Contact roll assembly 75	AR 5024-1253 936	Chapter 2-6
Contact roll assembly 70	AR 5024-1253 978	Chapter 2-6
Contact roll assembly 70 left	AR 5024-1253 986	Chapter 2-6
Contact roll assembly 75 left	AR 5024-1253 987	Chapter 2-6
Contact roll assembly 70 right	AR 5024-1253 990	Chapter 2-6
Contact roll assembly 75 right	AR 5024-1253 991	Chapter 2-6
Contact roll assembly 75	AR 5047-1253 935	Chapter 2-2
Contact roll assembly 70	AR 5047-1253 979	Chapter 2-2
Contact roll assembly 82,5	AR 5047-1253 980	Chapter 2-2
Counter roll	CK 668-0018 773	Chapter 7-6
Counter roll	CK 668-0012 083	Chapter 7-4,5
Counter roll	CK 668-0017 992	Chapter 7-4
Distance clip	OLC-0004 587	Chapter 5-72 Chapter 9-25,37,71,72,82

Designation	Ref. no.	Page
Distance clip	OLC-0004 588	Chapter 5-72 Chapter 9-25,37,71,72,82
Distance clip	OLC-0004 589	Chapter 5-72 Chapter 9-72,82
Distance clip	OLC-0007 685	Chapter 5-73
Distance clip	OLC-0007 686	Chapter 5-73
Distance clip	OLC-0007 687	Chapter 5-73
Distance clip	OLC-0007 688	Chapter 5-73
Distance clip	OLC-0017 627	Chapter 5-72 Chapter 9-24,25,36,37
Distance clip	OLC-0017 705	Chapter 5-72 Chapter 9-24,25,36,37
Distance clip	OLC-0030 491	Chapter 5-73 Chapter 9-50
Distance clip	OLC-0964 102	Chapter 5-73
Distance clip	OLC-0964 103	Chapter 5-73
Distance clip	OLC-0964 104	Chapter 5-73 Chapter 9-50,51,62
Distance clip	OLC-0964 105	Chapter 5-73 Chapter 9-50
Distance clip	OLC-0964 106	Chapter 5-73 Chapter 9-50,51,62
Distance clip	OLC-0964 107	Chapter 5-73 Chapter 9-50
Distance clip	OLC-0964 108	Chapter 5-73 Chapter 9-50,51,62
Distance clip	OLC-0964 109	Chapter 5-73 Chapter 9-50
Distance clip	OLC-0964 110	Chapter 5-73 Chapter 9-50
Distance clip	OLC-0964 117	Chapter 5-72 Chapter 9-24,25,36,37
Distance clip	OLC-0964 118	Chapter 5-72 Chapter 9-24,25,36,37
Distance clip	OLC-0964 119	Chapter 5-72 Chapter 9-24,25,36,37
Distance clip	OLC-0964 120	Chapter 5-72 Chapter 9-25,37,71,72,82
Distance clip	OLC-0964 123	Chapter 5-72 Chapter 9-72,82
Distance clip	OLC-0964 124	Chapter 5-72
Distance gauge	0011 687	Chapter 5-75
Distance piece	ADZ-0013 365	Chapter 2-3
Draft field gauge	0997 451	Chapter 5-76

Designation	Ref. no.	Page
Draft field gauge	1254 214	Chapter 5-78
Draft field gauge	6000 639	Chapter 5-79
Draft field gauge	6001 102	Chapter 5-74
Draft field gauge	0997 440	Chapter 5-75
Draw off roller	CK12-1250611	Chapter 2-22
Draw off roller with cot	CK12-1248 719	Chapter 2-22
Draw off roller with cot	ZL 20-1250 392	Chapter 2-22
Draw off roller with cot	ZL 20-1252 714	Chapter 2-22
Draw-off roller	CK 12-0030 848	Chapter 2-22
Draw-off roller	ZL 20-1256 486	Chapter 2-22
Elastic bush	EB 226-0030 746	Chapter 6-2
End cover	LPDE -1260 210	Chapter 3-2,3,4,5,6,7,8,9
False twist bearing unit	FL 15-0029 812	Chapter 7-8,9
False twist bearing unit	FL 15-0033 442	Chapter 7-8,9
False twist bearing unit	FL 15-1252 742	Chapter 7-7
False twist bearing unit	FL 15-1252 743	Chapter 7-7
False twist bearing unit	FL 15-1254 440	Chapter 7-7
False twist bearing unit	FL 15-1254 441	Chapter 7-7
False twist bearing unit	FL 66-0013 055	Chapter 7-2
Front clearer roller 68,4	1252 741	Chapter 5-6,10
Front clearer roller 68,4	1259 669	Chapter 5-3
Front clearer roller 75	1247 968	Chapter 5-6,10
Front clearer roller 75	1259 669	Chapter 5-3
Front clearer roller 82,5	1247 967	Chapter 5-6,10
Front clearer roller 82,5	1253 433	Chapter 5-3
Front clearer roller holder	1258 593	Chapter 5-3
Front guide element	PEL-0735 302	Chapter 9-80
Front zone condenser	KL-0998 282	Chapter 5-66
Front zone condenser	KL-1246 244	Chapter 9-65
Front zone condenser	KL-1248 235	Chapter 5-68
Front zone condenser	KL-0998 283	Chapter 9-86
Front zone condenser	KL-0998 284	Chapter 5-66
Front zone condenser	KL-0998 285	Chapter 9-65
Front zone condenser	KL-0998 285	Chapter 5-66
Front zone condenser 75	KL-1246 243	Chapter 9-65
Front zone condenser 75	KL-1248 233	Chapter 5-68
Front zone condenser 82.5	KL-1246 070	Chapter 9-76,86

Designation	Ref. no.	Page
Front zone condenser 82.5	KL-1248 234	Chapter 5-68 Chapter 9-76,86
Grease gun size 2	0993 073	Chapter 3-10 Chapter 4-10
Grease gun size 3	0993 091	Chapter 3-10 Chapter 4-10
Height gauge	0994 122	Chapter 5-75
Height gauge	0997 450	Chapter 5-76
Height setting gauge	1260 156	Chapter 5-74
Height setting gauge	1260 216	Chapter 5-79
Hexagon screwdriver	0993 570	Chapter 5-74,78,79
Isoflex super LDS 18	0038 425	Chapter 8-8
Lateral clearer roller holder	PPH-0727 593	Chapter 5-21
Locating clip	UCL-0964 125	Chapter 4-6
Locating clip	UCL-0964 126	Chapter 4-6
Locating clip	UCL-0964 127	Chapter 4-6
Locating clip	UCL-0964 128	Chapter 4-6
Locating clip	UCL-0964 129	Chapter 4-6
Locating clip	UCL-0964 136	Chapter 4-6
L-quick-connector	1257 477	Chapter 5-80,81
Lubricating adapter	0017 392	Chapter 1-15
Lubricating adapter	0019 983	Chapter 1-15
Lubricating adapter	0021 818	Chapter 1-15
Lubricating adapter	0994 252	Chapter 1-15
Lubricating adapter	0994 253	Chapter 1-15
Lubricating adapter	0998 111	Chapter 1-15
Lubricating adapter	0998 112	Chapter 1-15
Lubricating adapter	0998 279	Chapter 1-15
Lubricating adapter	1253 181	Chapter 1-15
Lubricating adapter	1253 182	Chapter 1-15
Lubricating adapter	1256 450	Chapter 1-15
Lubricating adapter	1256 451	Chapter 1-15
Lubricating adapter	1260 233	Chapter 1-15
Lubrication adapter	6001 019	Chapter 1-15
Lubricating device	1251 491	Chapter 7-15
Lubricating nozzle	0017 198	Chapter 4-10
Lubricating nozzle	0017 199	Chapter 4-10
Lubricating nozzle	0026 714	Chapter 4-10
Lubricating nozzle	0968 903	Chapter 3-10
Lubricating nozzle	0993 040	Chapter 4-10
Lubricating nozzle	1253 413	Chapter 4-10

Designation	Ref. no.	Page
Middle guide element	PEL-0735 303	Chapter 9-80
Mono clearer roller	PKPW-1253 433	Chapter 5-27
Mono clearer roller holder	PKHA-1252 848	Chapter 5-27
Nut	FMT-0010 953	Chapter 7-4
Nut	SMT-0012 478	Chapter 2-13
Oil Isoflex PDP 65	0019956	Chapter 8-9
Pin	0994 231	Chapter 7-15
Plastic cover	VDE-0002 607	Chapter 7-15
Plastic cover	VDE-0911 030	Chapter 7-15
Pliers	1256 207	Chapter 5-78, 79
Pliers for cover	1255 145	Chapter 5-74, 78, 79
Pneumatic unit	1261 442	Chapter 5-80, 81
Pneumatic unit	1261 445	Chapter 5-80, 81
Protecting cap	FKA-0019 933	Chapter 7-4
Ratchet	0997 453	Chapter 5-74, 75, 76, 78, 79
Rear guide element	PEL-0735 305	Chapter 9-80
Rear roving guide	KL-0011 034	Chapter 5-66
Rear zone condenser	KL-0997 469	Chapter 5-70
Rotor spindle	TL 226-1245 856	Chapter 9-76, 86 Chapter 6-2
Rotor spindle	TL 240-0018 814	Chapter 8-9 Chapter 6-4
Screwdriver	0993 551	Chapter 5-76
Screwdriver	0997 445	Chapter 5-77
Screwdriver	0997 491	Chapter 5-75
Screwdriver bit	0997 454	Chapter 5-75, 76
Screwdriver bit	0997 455	Chapter 5-75, 77
Screwdriver SW 6	1255 195	Chapter 5-74, 78, 79
Separator roll	VR 1-0964 428	Chapter 7-10 Chapter 8-8
Separator roll	VR 11-0964 434	Chapter 7-10 Chapter 8-8
Separator roll	VR 2-0964 430	Chapter 7-10 Chapter 8-8
Separator roll	VR 3-0025 015	Chapter 7-10
Separator roll	VR 3-0964 429	Chapter 7-10 Chapter 8-8
Separator roll	VR 3-0964 435	Chapter 7-10 Chapter 8-8
Separator roll	VR 4-0964 438	Chapter 7-10

Designation	Ref. no.	Page
Separator roll	VR 4-0964 445	Chapter 8-8 Chapter 7-10
Separator roll	VR 50-0964 450	Chapter 8-8
Separator roll	VR 6-0964 442	Chapter 8-8 Chapter 7-10
Separator roll	VR 7-0000 320	Chapter 8-8 Chapter 7-12
Separator roll	VR 7-0964 441	Chapter 8-8 Chapter 7-10
Separator roll	VR 7-0964 447	Chapter 8-8 Chapter 7-10
Separator roll	VR 8-0964 426	Chapter 7-10 Chapter 8-8
Setting wrench	0998 222	Chapter 5-75, 76
Slide calipers	0026 840	Chapter 5-75, 77
Spanner	1255 215	Chapter 5-78, 79
Spanner	0993 580	Chapter 5-76
Spindle bearing unit	CS	Chapter 8-5
Spindle bearing unit	HF	Chapter 8-5
Spindle bearing unit	HF 3-0952 502	Chapter 1-2
Spindle bearing unit	HF 3-0952 503	Chapter 1-2
Spindle bearing unit	HF 35-1254 243	Chapter 1-2
Spindle bearing unit	HF 44-0952 757	Chapter 1-2
Spindle bearing unit	HF 44-0952 760	Chapter 1-2
Spindle bearing unit	HF 45-1258 940	Chapter 1-2
Spindle bearing unit	HZ	Chapter 8-6
Spindle bearing unit	HZ 35-0018 299	Chapter 1-4
Spindle bearing unit	HZ 66-0014 227	Chapter 1-4
Spindle bearing unit	HZ 68-0017 830	Chapter 1-4
Spindle bearing unit	HZ 77-0952 381	Chapter 1-4
Spindle bearing unit	SMM 32-1280 013	Chapter 1-10
Spindle bearing unit	SMM 42-1280 014	Chapter 1-10
Spindle bearing unit	SMM-32	Chapter 8-12
Spindle bearing unit	SMM-42	Chapter 8-12
Spindle lubricating apparatus	1254 106	Chapter 8-10 Chapter 1-14
Spindle units CS1	CS1-	Chapter 1-6
Spring	PFE-0997 405	Chapter 5-68

Designation	Ref. no.	Page
Tape tension pulley	SR 23-0954 031	Chapter 8-2
Tape tension pulley	SR 23-0954 032	Chapter 8-2
Tape tension pulley	SR 23-0954 034	Chapter 8-2
Tape tension pulley	SR 23-0954 035	Chapter 8-2
Tape tension pulley	SR 28-0012 473	Chapter 2-12
		Chapter 8-2
Tape tension pulley	SR 28-0012 474	Chapter 2-12
		Chapter 8-2
Tape tension pulley	SR 28-0015 799	Chapter 8-2
Tape tension pulley	SR 45-0008 937	Chapter 8-2
Tape tension pulley	SR 45-0028 044	Chapter 2-12
		Chapter 8-2
Tape tension pulley	SR 5047-1255 461	Chapter 8-2
Tension pulley	SR 5047-1255 698	Chapter 2-10
Tape tension pulley	SR 5047-1255 699	Chapter 8-2
		Chapter 2-10
Tape tension pulley	SR 7-0030 782	Chapter 8-2
Tape tension pulley	SR 9-0953 201	Chapter 8-2
TEXParts grease TG 5	0026 878	Chapter 8-3
TEXParts grease TG2	0026 877	Chapter 8-3
Tool set with bag	1259 672	Chapter 5-74
Tool set with bag	0994 131	Chapter 5-76
Tool set with bag	1251 683	Chapter 5-75
Tool set with bag	1253 714	Chapter 5-78
Tool set with bag	1259 479	Chapter 5-79
Top apron	PR-0022 858	Chapter 9-71
Top apron	PR-1253 678	Chapter 9-71
Top apron cradle 68.4	OH 122-0963 495	Chapter 5-8,12,42,44
		Chapter 9-36
Top apron cradle 75	OH 122-0963 500	Chapter 5-8,12,42,44
		Chapter 9-36
Top apron cradle 82.5	OH 122-0963 511	Chapter 5-4,8,12,42,44
		Chapter 9-36
Top apron cradle 75	OH 1225-6001 257	Chapter 5-4,42
		Chapter 9-24
Top apron cradle 68.4	OH 1225-6001 674	Chapter 5-4,42
		Chapter 9-24
Top apron cradle 82.5	OH 1225-6001 675	Chapter 5-4,42

Designation	Ref. no.	Page
Top apron cradle 75	OH 132-0963 660	Chapter 9-24
Top apron cradle 82.5	OH 132-0963 671	Chapter 5-8,12,40
		Chapter 5-8,12,40
		Chapter 9-36
Top apron cradle 68.4	OH 132-0963 700	Chapter 5-8,12,40
Top apron cradle 75	OH 2022-1247 887	Chapter 5-4,8,12,34
		Chapter 9-24,36
Top apron cradle 68.4	OH 2022-1247 888	Chapter 5-4,8,12,34
		Chapter 9-24,36
Top apron cradle 82.5	OH 2022-1247 889	Chapter 5-4,8,12,34
		Chapter 9-24,36
Top apron cradle 68.4	OH 2042-1250 133	Chapter 5-4,8,12,38
		Chapter 9-24,36
Top apron cradle 75	OH 2042-1250 134	Chapter 5-4,8,12,38
		Chapter 9-24,36
Top apron cradle 75	OH 2402-1253 436	Chapter 5-32,58
Top apron cradle 82.5	OH 2402-1253 437	Chapter 5-32,58
Top apron cradle 110	OH 5022-1259 297	Chapter 5-16,18,46
		Chapter 9-51
Top apron cradle 110	OH 5042-1259 506	Chapter 5-16,18,50
Top apron cradle 82.5	OH 514-0962 744	Chapter 5-48
Top apron cradle100	OH 514-0962 745	Chapter 5-22,24,48
		Chapter 9-62
Top apron cradle 110	OH 514-0962 746	Chapter 5-48
		Chapter 9-62
Top apron cradle 130	OH 514-0962 747	Chapter 5-22,24,48
		Chapter 9-62
Top apron cradle82.5	OH 524-0962 753	Chapter 5-56
Top apron cradle 110	OH 524-0962 755	Chapter 5-22,56
		Chapter 9-62
Top apron cradle 110	OH 5245-1260 370	Chapter 5-16,54
		Chapter 9-51
Top apron cradle 100	OH 534-0962 764	Chapter 5-22,52
		Chapter 9-62
Top apron cradle 110	OH 534-0962 765	Chapter 5-22,52
		Chapter 9-62
Top apron cradle 130	OH 534-0962 766	Chapter 5-22,52
		Chapter 9-62
Top apron cradle 75	OH 554-0962 767	Chapter 5-32,60
Top apron cradle 82.5	OH 554-0962 768	Chapter 5-32,60
Top apron cradle 90	OH 554-0962 769	Chapter 5-32,60
Top apron cradle 75	OH 6022-1254 311	Chapter 5-28,62
Top apron cradle 82.5	OH 6022-1254 312	Chapter 5-28,62
Top apron cradle 90	OH 62-0962 841	Chapter 5-4,8,12,36
		Chapter 9-36

Designation	Ref. no.	Page
Top roller 100	LP 1002-0956 274	Chapter 3-2
Top roller 75	LP 1002-1248 379	Chapter 3-2
Top roller 82.5	LP 1002-1248 382	Chapter 5- 4,8,12
Top roller 75	LP 1002-1248 601	Chapter 3-2
Top roller 68.4	LP 1002-1249 324	Chapter 5-4,8,12
Top roller 82.5	LP 1002-1256 896	Chapter 3-2
Top roller	LP 1002-1256 897	Chapter 5-4,8,12
Top roller 90	LP 1002-1256 898	Chapter 5-8,12
Top roller 68.4	LP 1003-1256 596	Chapter 3-2
Top roller 75	LP 1003-1256 597	Chapter 5-4,8,12
Top roller 82.5	LP 1003-1256 598	Chapter 3-4
Top roller 90	LP 1003-1256 599	Chapter 5-4,8,12
Top roller 100	LP 1014-0025 222	Chapter 3-4
Top roller 75	LP 1014-1253 740	Chapter 3-5
Top roller 82.5	LP 1014-1253 741	Chapter 3-5
Top roller 90	LP 1014-1253 742	Chapter 5-28,32
Top roller 100	LP 1015-0025 227	Chapter 3-5
Top roller 110	LP 1015-0025 228	Chapter 3-6
Top roller 130	LP 1015-0025 229	Chapter 5-22,24
Top roller 82.5	LP 1015-1253 744	Chapter 5-16,18,22,24
Top roller 90	LP 1015-1253 745	Chapter 3-6
Top roller 75	LP 1016-1256 711	Chapter 9-51
		Chapter 3-6
		Chapter 5-22,24
		Chapter 3-6
		Chapter 5-28
		Chapter 9-71
		Chapter 3-6
		Chapter 3-7
		Chapter 5-32
		Chapter 9-82

Designation	Ref. no.	Page
Top roller 100	LP 1017-0013 010	Chapter 3-7
Top roller 110	LP 1017-0013 011	Chapter 5-22,24
Top roller 130	LP 1017-0013 012	Chapter 9-62,82
Top roller 82.5	LP 1017-1256 712	Chapter 3-7
Top roller 90	LP 1017-1256 713	Chapter 5-22,24
Top roller 80	LP 302-0010 011	Chapter 9-62
Top roller 70	LP 302-0010 014	Chapter 3-7
Top roller 75	LP 302-0010 015	Chapter 5-32
Top roller 90	LP 302-0010 016	Chapter 9-82
Top roller 75	LP 302-0015 895	Chapter 3-7
Top roller 70	LP 302-0019 135	Chapter 5-32
Top roller 80	LP 302-0019 136	Chapter 9-82
Top roller 90	LP 302-0019 137	Chapter 3-7
Top rollers	LP	Chapter 5-32
Torque key with insert	1259 653	Chapter 9-82
T-screwing	1259 647	Chapter 3-9
Tube cutter	6001 490	Chapter 3-9
Weighting arm	PK 1500-0001 938	Chapter 3-9
Weighting arm	PK 1500-0962 602	Chapter 3-9
Weighting arm	PK 1500-0962 604	Chapter 3-9
Weighting arm	PK 1601-0962 670	Chapter 3-8
Weighting arm	PK 2025-1251 331	Chapter 3-8
Weighting arm	PK 2035-1251 784	Chapter 3-8
		Chapter 5-74,79
		Chapter 5-80,81
		Chapter 5-74,79
		Chapter 5-20,24
		Chapter 9-56,57,58,59,60
		Chapter 5-20,22
		Chapter 9-55,57,58,59,60
		Chapter 5-20,22
		Chapter 9-55,57,58,59,60
		Chapter 5-30,32
		Chapter 9-77,79
		Chapter 5-6,8
		Chapter 9-28,31,33
		Chapter 5-6,8
		Chapter 9-28,31,33

Designation	Ref. no.	Page
Weighting arm	PK 2055-1251 785	Chapter 5-10,12 Chapter 9-28,31,33
Weighting arm	PK 2065-1251 786	Chapter 5-10,12 Chapter 9-28,31,33
Weighting arm	PK 3025-1257 300	Chapter 5-2,4 Chapter 9-18,20,21
Weighting arm	PK 3035-1259 710	Chapter 5-2,4 Chapter 9-18,20,21
Weighting arm	PK 5025-1259 471	Chapter 5-14,16 Chapter 9-42,45,46,49
Weighting arm	PK 5025-1259 472	Chapter 5-15,18 Chapter 9-42,45,46,49
Weighting arm	PK 5035-1259 473	Chapter 5-14,16 Chapter 9-42,45,46,49
Weighting arm	PK 5035-1259 474	Chapter 5-15,18 Chapter 9-42,45,46,49
Weighting arm	PK 6000-1252 924	Chapter 5-26,28 Chapter 9-66,68
Wharve	CWL-0012 117	Chapter 7-5